

Contract Report 2014-01

Continued Operation of a 25-Raingage Network for Collection, Reduction, and Analysis of Precipitation Data for Lake Michigan Diversion Accounting: Water Year 2013

Nancy E. Westcott

February 2014



Illinois State Water Survey
Prairie Research Institute
University of Illinois at Urbana-Champaign
Champaign, Illinois



CONTINUED OPERATION OF A 25-RAINGAGE NETWORK
FOR COLLECTION, REDUCTION, AND ANALYSIS OF PRECIPITATION DATA
FOR LAKE MICHIGAN DIVERSION ACCOUNTING:
WATER YEAR 2013

FINAL REPORT

To

U.S. Army Corps of Engineers, Chicago District

Contract

W912P6-08-C-0029

Nancy E. Westcott
Principal Investigator

Illinois State Water Survey
Prairie Research Institute
University of Illinois
2204 Griffith Drive
Champaign, Illinois 61820-7495

February 28, 2014

This paper was printed on recycled and recyclable paper.

ABSTRACT

A dense raingage network has operated in Cook County since the fall of 1989 to provide accurate precipitation measurements for use in simulating runoff for Lake Michigan diversion accounting. This report describes the network design, the operations and maintenance procedures, the data reduction and quality control methodology, and an analysis of precipitation for Water Year 2013 (October 2012–September 2013). The data analyses include 1) monthly and Water Year 2013 amounts at all sites, 2) Water Year 2013 amounts in comparison to patterns from network Water Years 1990–2012, and 3) the 24-year network precipitation average for Water Years 1990–2013. Also included are raingage site descriptions, instructions for raingage technicians, documentation of raingage maintenance, and documentation of high storm totals.

CONTENTS

| | PAGE |
|-----------------------------------------------------|------|
| 1. Introduction | 1 |
| 2. Network Design | 5 |
| 3. Network Operation and Maintenance | 6 |
| 4. Data Reduction | 9 |
| 5. Data Analysis for Water Year 2013 | 10 |
| 6. Summary | 27 |
| 7. Acknowledgments | 27 |
| 8. References | 28 |
| Appendix I: Raingage Site Descriptions | 33 |
| Appendix II: Instructions for Raingage Technicians | 47 |
| Appendix III: Documentation of Raingage Maintenance | 49 |
| Appendix IV: Documentation of High Storm Totals | 77 |

**UPGRADE AND CONTINUED OPERATION OF A 25-RAINGAGE NETWORK
FOR COLLECTION, REDUCTION, AND ANALYSIS OF PRECIPITATION DATA
FOR LAKE MICHIGAN DIVERSION ACCOUNTING:
WATER YEAR 2013**

by

Nancy E. Westcott, Meteorologist

1. INTRODUCTION

The volume of water diverted from Lake Michigan into the state of Illinois is monitored to ensure that the diversion does not exceed a long-term average of 3,200 cubic feet per second (cfs) as imposed by a 1967 U.S. Supreme Court Order, which was updated in 1980. This diversion has a long history, dating back to the mid-1800s with the completion of the Illinois and Michigan Canals. Over the years, it has been affected by such events as the flow reversal of the Chicago River and completion of the Chicago Sanitary and Ship Canal in 1900, and has weathered various legal proceedings that attempted to ensure that the diversion could be monitored and did not exceed certain limits. One of the key components of the monitoring procedure, administered by the U.S. Army Corps of Engineers (USACE), Chicago District, is the accurate representation of the precipitation that falls over portions of Cook County, Illinois.

The primary components of Illinois' diversion from Lake Michigan are as follows: 1) water is pumped directly from Lake Michigan as the source of potable water supply and discharged into the river and canal system in the greater Chicago area as treated sewage; 2) storm runoff is discharged from the diverted watershed area of Lake Michigan, draining to the river and canal system; and 3) water enters the river and canal system directly from Lake Michigan.

Storm runoff from the Lake Michigan watershed basin enters combined and separate sewer systems and watercourses. The combined sewers mix sanitary system flow with runoff, and this water then goes to treatment plants or, during major flood events, is discharged into the watercourses. When large storm events are predicted (and greater than normal storm runoff is anticipated), the canal system is drawn down prior to the event to prevent flooding. If the event fails to materialize, canal system levels are restored using a direct diversion from Lake Michigan through two facilities located at the lakefront: the Chicago River Controlling Works, and the O'Brien Lock and Dam.

The method for computing the diversion involves the direct measurement of diversion flow at Lemont, Illinois, as measured by an acoustic velocity meter. Flow at Lemont consists of both diversion and non-diversion flows (deductions). The theory behind diversion accounting is to use the flow at Lemont and deduct from it flows not

attributable to diversion. Diversion flows that bypass Lemont are added to the resultant flow, yielding a net computed diversion of water from Lake Michigan. The deductions to the Lemont record include runoff from 217 square miles of the Des Plaines River watershed that is discharged into the canal, the groundwater supply whose effluent is discharged into the canal, water used by federal facilities, and the Indiana water supply that is discharged into the canal via the Calumet River system and the Calumet Sag Channel.

The diversion is approximated by adding the Lake Michigan water supply pumpage, direct diversions from Lake Michigan, and runoff from 673 square miles of diverted Lake Michigan watershed. This approximation is performed to cross-check the computed diversion.

In both of these procedures, it is necessary to estimate runoff from the Des Plaines River and the Lake Michigan watersheds. Hydrologic simulations of runoff perform two functions. One function is to model runoff. The second function is to aid in determining the inflow, infiltration, and sanitary proportions of treatment plant discharge. Inputs into the simulation model consist of land-use, hydrological parameters, and climatological data. Of the latter, the most significant are precipitation data.

Thus accurate precipitation data are essential to properly simulate the runoff process. Runoff can constitute a significant portion of the diversion. For example, from Water Year 2004 through Water Year 2009 (a water year extends from October 1 of the preceding year through September 30 of the current calendar year), runoff from the Des Plaines River watershed constituted a 213 cfs (7.2 percent) deduction from the Romeoville or Lemont measurement record in the diversion computations. In the cross-check approximations, the Lake Michigan watershed runoff constituted a 982 cfs (31 percent) share of the total allowed diversion.

However, the precipitation data available for use by the accounting procedure prior to Water Year 1990 (particularly Water Years 1984–1989) displayed patterns inconsistent with known, long-term Chicago-area patterns (e.g., Changnon, 1961, 1968; Huff and Changnon, 1973; Vogel, 1988, 1989; Peppler, 1990, 1991a, 1993a). These patterns also diverge from the known urban effects found within the precipitation patterns for the Cook County region for heavier rainfall 1949–1974 distributions (Huff and Vogel, 1976), particularly toward the south, and within patterns observed during the operation of a dense raingage network and radar system in the Chicago area during the late 1970s (Changnon, 1980, 1984).

The unusual patterns were caused by abnormally low precipitation totals at a select number of the 13 sites used by the accounting procedure (Figure 1). Inspection of these sites (Vogel, 1988), which are irregularly distributed over the region, revealed that low precipitation totals were caused by 1) inadequate raingage exposure (e.g., gages situated on rooftops or too near natural or artificial air flow-restricting

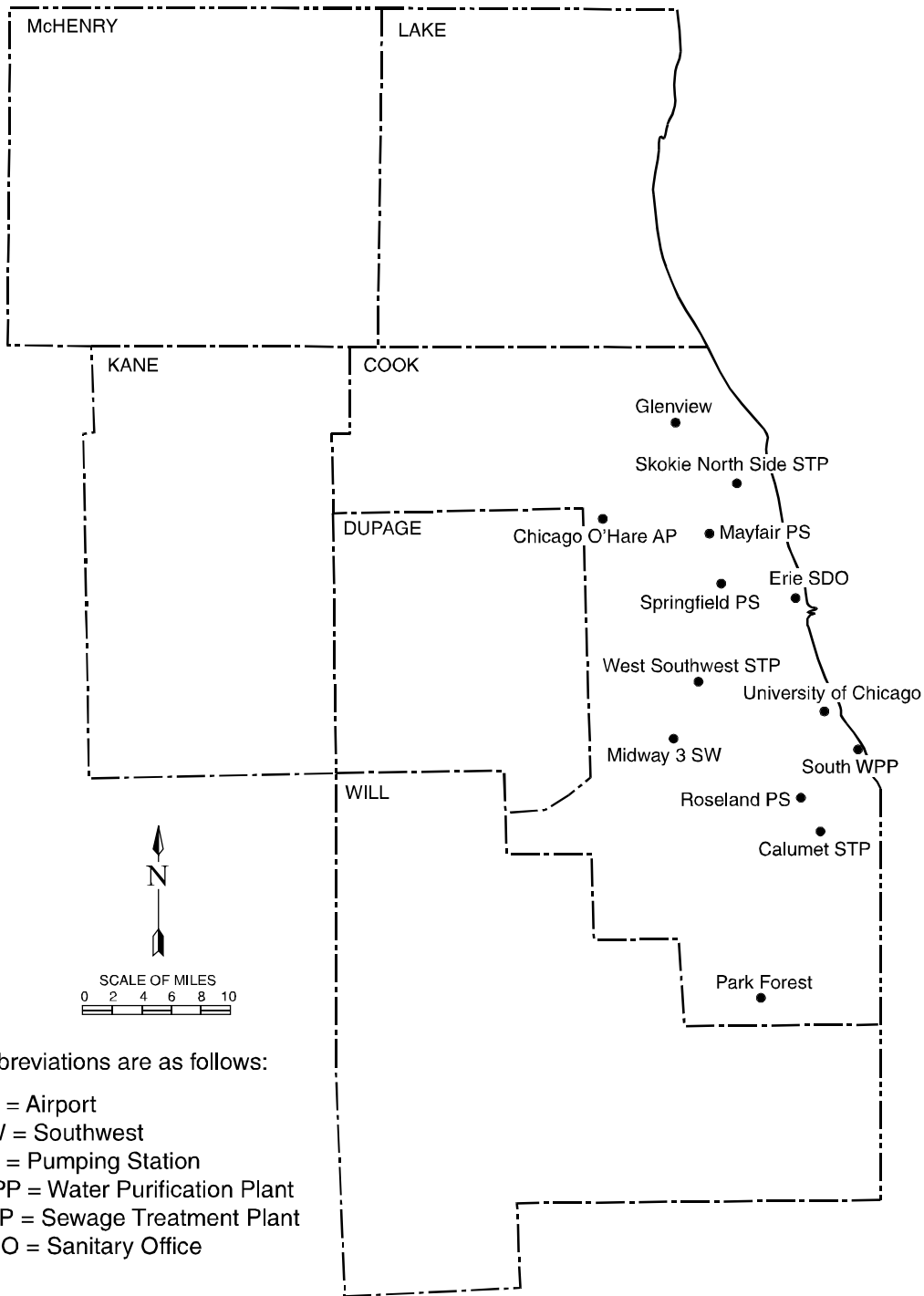

Figure 1. Raingage locations used for diversion accounting purposes prior to Water Year 1990. These include National Weather Service gages located at Chicago O’Hare AP, Midway 3 SW, University of Chicago, and Park Forest; City of Chicago gages located at Mayfair PS, Springfield PS, South WPP, and Roseland PS; and Metropolitan Water Reclamation District of Greater Chicago gages located at Glenview, Skokie North Side STP, Erie SDO, West Southwest STP, and Calumet STP.

obstructions) and 2) different observing, data reduction, and quality control practices used by the individual groups responsible for raingage operation and data collection (National Weather Service - NWS, Metropolitan Water Reclamation District of Greater Chicago - MWRDGC, and City of Chicago - CC). Vogel (1988) established that the unusual precipitation patterns began occurring in the late 1960s when some changes were made in data collection and reduction.

Vogel (1988) devised a procedure to adjust the questionable values, thus making the data suitable for use in the accounting procedure. This procedure was tedious to implement, however, and the adjusted precipitation values may not have completely captured the actual precipitation regime, although the data produced were much improved over the original values. This procedure also illuminated difficulties experienced when trying to merge data observations from different agencies and equipment into one dataset. Vogel (1988) gave the following recommendation at the end of his report on the reduction and adjustment of the Water Year 1984 data and on field evaluations of the NWS, MWRDGC, and CC sites:

“With these types of differences it will always be hard to maintain a consistent set of high-quality precipitation observations for the Chicago urban region. A precipitation network which must produce a set of high-quality observations should have a consistent set of gages; should be managed by one group with fixed quality control procedures, exposure criteria, and a set operating procedure. Management by one group would allow for consistent 1) observations, 2) quality control, and 3) spatial and temporal precipitation patterns.

“To achieve this, it is recommended that a raingage network be established to monitor the precipitation over northeast Illinois relevant to the diversion of Lake Michigan waters. This network should consist of 10 to 15 weighing-bucket-recording raingages. The raingages should be reasonably spaced across the affected area. The network should be managed by one group to ensure that the best possible exposures are obtained initially, and that these exposures are inspected at least annually. The data from such a network should all be quality-controlled in a consistent manner.

“Weighing-bucket raingages with daily charts would be capable of obtaining hourly or smaller time increments if daily charts are used. To reduce costs and to increase security, it is recommended that these raingages be located on private property, and that the observers be given a modest annual stipend. The charts from the observers should be mailed to a central location for data processing, quality control, and extraction of hourly precipitation totals. Raingages should be evenly spaced, as much as possible, and sites would be found after consulting with the agencies involved (pp. 41–42).

Using Vogel's recommendation as a model, the Illinois State Water Survey (ISWS) and the USACE jointly decided in late 1988 to devise, install, and operate a new

raingage network, funded by the USACE. The purpose of the new network was to produce consistent, accurate data for the diversion accounting, which would require little or no adjustment. Implementation and operation of such a network would have to be justified on the grounds of both long-term cost savings and greater accuracy.

This report describes the maintenance and operation of the network, along with the data reduction and analysis techniques employed, and a brief data analyses for Water Year 2013, year 24 of network operation.

2. NETWORK DESIGN

The ISWS has operated dense raingage networks in the past (e.g., Huff, 1970, 1979), which tested gridded raingage spacing of 6 feet to 6 miles. Adequate sampling of convective precipitation (typical in spring and summer) was found to require nearly twice as many gages as required for more widespread, long-lived precipitation (fall and winter). With that in mind, and opting for optimum grid spacing, an initial attempt at creating a grid resulted in an array of 40 raingages located in the Cook County region in the Lake Michigan and Des Plaines River watersheds of the MWRDGC North, Central, South, and Lemont basins. Due to cost considerations, however, some spring/summer catchment ability was sacrificed, and a 25-site grid was devised using 5- to 7-mile grid spacing between gages. Also due to cost considerations, raingages were not installed outside the watershed boundaries to better define isohyetal patterns at those boundaries. These 25 raingages, more than the 10 to 15 gages Vogel had originally envisioned, have provided adequate coverage for precipitation catchment since its inception in Water Year 1990 (Peppler, 1991b, 1991c, 1993b, 1994, 1995; Westcott, 1996, 1997, 1998, 1999, 2000, 2001, 2002, 2003, 2004, 2005, 2006, 2007a, 2007b, 2009a, 2010, 2011, 2012 and 2013), and are consistent with the "best current engineering practice" as specified in the 1967 and 1980 United States Supreme Court decrees. Daily multi-sensor (radar plus gage) precipitation data valid at 06:00 CST (Central Standard Time) are now available for the region but do not yet adequately represent precipitation (Westcott et al., 2008; Westcott, 2009b).

Topographic maps of the Cook County region were used to approximate the location of each of the 25 sites and fine-tune their placement to best position the sites with respect to residential areas, industrial facilities, or municipal grounds. Because terrain effects are fairly minimal in northeastern Illinois, gridding was possible. Gridding also allows the use of simple arithmetic averaging to compute areal depths instead of other labor-intensive methods such as the Thiessen polygonal method.

Once candidate locations were found, several preliminary field trips were made to the Cook County region, and letters were written by the ISWS in summer 1989 seeking permission to use the selected locations as raingage sites. Due to the urbanization of the region, site selection was sometimes a frustrating venture, as it was difficult in many instances to identify good catchment areas free of barriers for ground-level placement. When selecting sites, highest priority was given to those at ground level in relatively open, secure areas. This is because obstructions and local wind

eddies produced by flow barriers present the largest sources of error in collecting precipitation data. Placing the collector at ground level reduces wind effects on catchment and represents the ideal exposure (Legates and Willmott, 1990), but it is not practical in wintertime when snow is measured. Thus, as has been standard ISWS practice, each raingage was to be placed on stakes with its base approximately 8 inches above ground level and the top of its orifice at about 4 feet. When asked for permission to site a raingage on their property, most individuals, businesses, and municipalities were extremely receptive. As of September 30, 2013, 15 sites have been relocated to a different property since the network began collecting data in October 1989.

In late September and early October 1989, the entire 25-gage network was installed (Figure 2). Appendix I contains complete site descriptions for each network location, accurate as of September 30, 2013. Each universal weighing-bucket raingage used throughout the network was fitted with a battery-powered chart drive that rotated the 24-hour charts approximately once per day. The ISWS provided all raingages from its inventory. To improve the accuracy and reliability of the raingages, as of February 1, 2001, the 25 raingages were redeployed, fitted with linear potentiometers and data loggers, in addition to the battery-powered chart drive. The chart drive was altered to use 8-day charts instead of 24-hour charts to accommodate monthly instead of weekly servicing. During Water Year 2010, the 25 raingages were redeployed with a new data logger and cell modem, powered by a 12-volt battery and solar panel to obtain data in real-time. Three days of 10-minute data and two weeks of hourly data now are available via the web at <http://www.isws.illinois.edu/atmos/ccprecipnet/> (select Current Data).

The weighing-bucket recording raingages used are as reliable as any others available (see Jones, 1969, for a complete description of tests of different raingages). All raingages are subject to catchment errors due to wind, wetting losses, evaporation, splashing into or out of the gage, and blowing snow (Legates and Willmott, 1990). Koschmieder (1934) noted that as wind speed increases, gage catch decreases. Legates and Willmott (1990) found that raingage errors "tend to be proportional to total precipitation and amount to nearly 11 percent of the catch." To prevent loss due to blowing snow during the winter, the Nipher shield and the shield used by Lindroth (1991) are helpful, but were not considered for the new network due to cost and vandalism considerations. In October 1996, an Alter shield was installed at site #14, a very windy lakefront location.

3. NETWORK OPERATION AND MAINTENANCE

The first generation of the 25-raingage network was used from October 1989 to February 2001. This setup used the Belfort gage as it was originally designed. This design used a galvanized bucket that held 12 inches of precipitation calibrated to an 8-inch collection orifice opening, with data recorded on charts. The charts measured up to 12 inches of precipitation. The upward pen traverse on a chart measured the first 6 inches the bucket caught, and a reversed, downward pen traverse measured inches 7–12. Use of the latter traverse occurred infrequently, but was vital whenever more than 6

inches of precipitation occurred between chart periods or during winter when the antifreeze-charged buckets accumulated precipitation for long periods. This generation of gages used a battery-operated clock to rotate a 24-hour chart. The time on the charts was set by the observer's watch to CST. Charts were collected and sent to ISWS weekly by David and Dorothy Rosenberg, and then edited and digitized at the ISWS.

The second generation of gages was used from February 2001 through September 2010. Each raingage in the network was fitted with a linear potentiometer to convert the weight of the water into a corresponding voltage, and a TattleTale-8 data logger (Onset Computer Corp., Cape Cod, MA) that used 8 AA batteries for power. The 24-hour gear set was replaced with 8-day chart cylinder gears that rotated the chart cylinder approximately once per week. The timing resolution of the charts was somewhat reduced, but still adequate for hourly measurements, and the rainfall accuracy for the 8-day charts was comparable to the 24-hour charts (Westcott, 2002). The change in clock gears allowed the ISWS technician to change the charts monthly when data were collected from the data loggers. The data loggers recorded the date, time (CST), and an accumulated precipitation total every 10 minutes. The data were downloaded to a laptop computer during the first week of each month for processing and quality control. The time on the data loggers was set using the laptop clock. The charts were digitized for all gages through Water Year 2008 and only for individual gages with questionable digital data in Water Years 2009 and 2010.

In 2010, the third generation of refurbished weighing-bucket Belfort gages was installed in the network, replacing the TattleTale-8 data loggers and chart drives with Campbell CR200 data loggers (Campbell Scientific Inc., Logan, Utah) and cell modems. This model of data logger has non-volatile memory. If the power is lost to the logger, the time, date, program, and 10-minute precipitation and battery voltage are stored in memory. When power is restored to a data logger, it will return to operating condition. The data are both transmitted to an ISWS computer on an hourly basis and are stored on the Campbell data logger. The new data loggers and modems are powered by a 12-volt absorbent glass mat (agm) battery with solar recharge. Data loggers are programmed to activate the modem at the top of the hour only if the battery has 12 volts or more of power, so that if the battery drops below this threshold, it is still able to power the data logger. A computer at the ISWS is programmed to retrieve the data at the top of the hour and append the data to an existing file. This file is then displayed on the web page. If a battery at a specific site falls below 12-volts, the data are retrieved when the battery charge is restored to above threshold values by either solar energy or manually by changing the battery with a fully charged battery.

Using 7-watt flex solar panels and dipole antennas, most gage sites have sufficient solar exposure and cell-phone coverage to transmit hourly. The gage at Site #7, while having strong cell-phone coverage, only sends data at midnight as wireless usage in the area seems to prohibit routine hourly transmission. Rigid 10-watt solar panels have been connected to several gages (#2, #3, #4, #6, #7, #8, #10, #15, and #21) to obtain adequate solar exposure for power generation during the winter months, minimizing the need to download data manually. Wilson antennas were installed at a

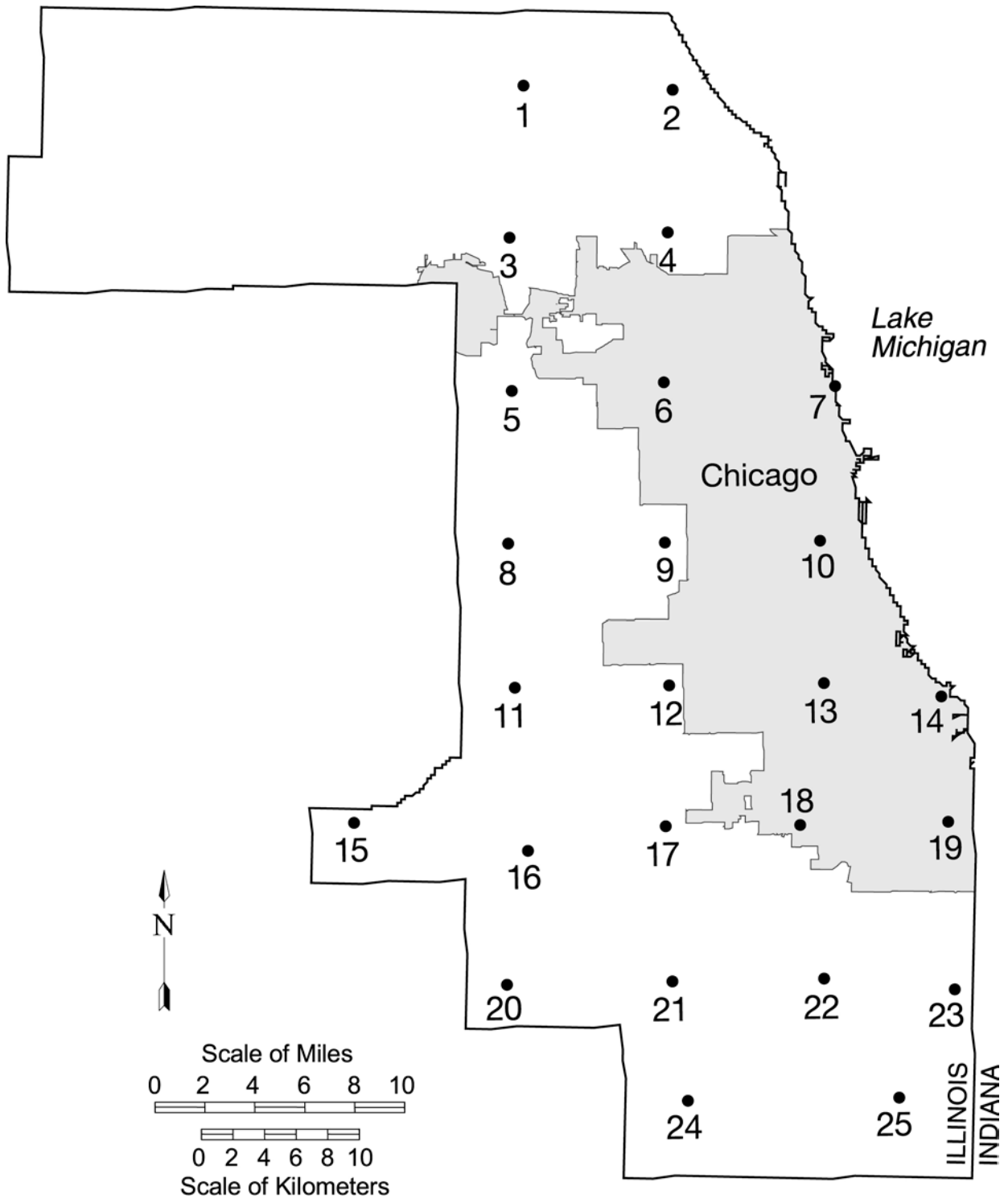

Figure 2. The Cook County 25-site rain gauge network for Water Years 1990-2013. City of Chicago indicated by shading.

number of gages to provide for more reliable data transmission (#2, #3, #4, #5, #7, #8, #10, #12, #13, #14, #19, #21, and #25) and an omni antenna at #17, #18, and #22. A PolyPhaser in-line surge filter has been added to most Wilson antennas to reduce susceptibility to electrical surges. A grounding rod has been added to most gages. The new gage system precludes the necessity of chart drives, and thus all were removed from the refurbished gages.

Up until the 2010 launch of the real-time data transmission, a raingage technician residing in Champaign, Illinois, traveled to Cook County and serviced each gage during the first week of each month. Servicing included downloading data from data loggers, recalibrating the gage, emptying the bucket, and noting any problems, including gage imbalance or instability, data logger malfunction, vandalism, and unauthorized movement of the gage. Now, travel to the network occurs only when necessary, such as when the buckets are becoming full, when batteries need to be replaced, when a gage appears to malfunction, when we are informed of vandalism by the gage site property owners or managers, and for twice-yearly servicing that includes calibration and either adding or removing anti-freeze. At the beginning of the cold season (November–March), a 1-liter charge of antifreeze with an anti-evaporation suppressant is added to each bucket. Antifreeze causes frozen precipitation to melt in the bucket as it is caught, allowing the weighing mechanism to give a proper reading. Plastic buckets are now used, and are emptied and recharged with antifreeze when needed. Appendix II contains the complete set of servicing instructions for raingage technicians. Appendix III provides a complete maintenance history of the raingage network, including site relocations, and the maintenance and repairs conducted. This information is accurate through September 30, 2013.

A test bed of reserve raingages was set up at the ISWS in fall 2006, and moved to the nearby ISWS Bondville Site in 2011. Daily data from these gages are compared with the National Oceanic and Atmospheric Administration (NOAA) gages and the Illinois Climate Network gage at the same location. Suspicious gages in the network are replaced with one of these reserve gages that compares well with the NOAA Cooperative gage. During 2010, all 25 gages were replaced with gages that had been compared with a NOAA standard gage, and also were subjected to a laboratory drip test. In addition, during the warm season months when temperatures are above freezing and anti-freeze is not needed, we began to weigh the water in the gages (at ISWS and in Cook County), convert that amount to inches, and compare it with the amount of rain recorded by the data logger. This has allowed us to be more confident of the raingage calibrations and gage totals.

4. DATA REDUCTION

Data Loggers

The minimum rainfall amount recorded by the data logger is 0.01 inch every 10 minutes. Often electronic noise is present as evidenced by 10-minute values oscillating between -0.01-inch and 0.01-inch values. Noise can be caused by wind or other

vibrations. Computer software was developed to set 10-minute values to zero if within ± 10 minutes of a -0.01-inch value. Further, if an isolated positive 10-minute value is found (no other precipitation for ± 180 minutes), that value also is set to zero. These 10-minute accumulated precipitation amounts then are summed to hourly values and displayed in a format comparable to that already established for the analog chart data. Here, more noise is eliminated. Noisy values are denoted as 88.88. Values usually are considered part of a precipitation event if more than two adjacent gages detect precipitation during the same hour. However, it has been noted that there often are “events” in the hours just after sunrise. It is believed that these frequent events are related to a rapid heating of the raingage, as they were not recorded by the analog charts during the years when they were in use. These early morning events are deleted unless the NWS gages or Community Cooperative Rain Hail and Snow Network (CoCoRaHS) gages located in Cook County also report precipitation, or unless the NWS radar indicates precipitation.

Final Data Array

The precipitation data array created from the data logger data is checked for time and space consistency, storm periods are delimited, and missing values are filled in with interpolated information. A storm is defined as a precipitation period separated from preceding and succeeding precipitation periods by approximately six hours at all stations in the network. This definition was used by Huff (1967) for an area of similar dimensions in central Illinois, by Vogel (1986) to define extreme storm events in the Chicago area, and by Vogel (1988, 1989), Peppler (1990, 1991a-c, 1993a,b, 1994, and 1995), and Westcott (1996, 1997, 1998, 1999, 2000, 2001, 2002, 2003, 2004, 2005, 2006, 2007a, 2007b, 2009a, 2010, 2011, 2012 and 2013) to delineate storms for Water Years 1984–2012. For each storm, values are summed and plotted on maps using all available data and stations, and isohyetal patterns are drawn. During Water Year 2013, 125 such storms were defined.

If a data logger fails during the month, a computer program using a distance weighted linear interpolation scheme is executed to objectively determine new values for missing hours. The objective routine also is used to re-create values at gage sites for which questionable values are identified during the storm analysis stage. When buckets reach their capacity of 13 inches, linear interpolation of additional precipitation also will be required. Evaporation shields have been removed from the gages to reduce the likelihood of bucket overflow. The chance of missing data is greatly reduced with the installation of the new data loggers because of their non-volatile memory property. Once storm totals have been examined and accepted, a final computer file of hourly precipitation values for the month being analyzed is archived.

5. DATA ANALYSIS FOR WATER YEAR 2013

The Water Year 2013 dataset was used to produce various analyses, including 1) monthly and Water Year 2013 amounts at all sites, 2) water year amounts and comparisons to patterns from network Water Years 1990–2012, 3) monthly amounts as

documentation of the data collected, and 4) an analysis of the 24-year network precipitation average for Water Years 1990–2013.

Table 1 and Figure 3 show Water Year 2013 precipitation amounts. Isoleths in Figure 4 are labeled in inches, while values in Table 1 are given to the nearest hundredth of an inch. Water Year 2013 was near average in precipitation amount. Network average precipitation for Water Years 1990–2012 were 40.00, 39.19, 36.56, 51.78, 29.23, 34.68, 36.88, 34.09, 36.12, 36.33, 33.33, 36.39, 33.37, 29.03, 35.24, 27.29, 35.89, 41.47, 43.44, 40.85, 44.46, 41.78 and 28.30 inches, respectively.

Table 1. Monthly and Annual Precipitation Amounts for Water Year 2013 (inches)

| <i>Station</i> | <i>Oct</i> | <i>Nov</i> | <i>Dec</i> | <i>Jan</i> | <i>Feb</i> | <i>Mar</i> | <i>Apr</i> | <i>May</i> | <i>Jun</i> | <i>Jul</i> | <i>Aug</i> | <i>Sep</i> | <i>Total</i> |
|----------------|------------|------------|------------|------------|------------|------------|------------|------------|------------|------------|------------|------------|--------------|
| 1 | 2.10 | 0.67 | 2.18 | 3.45 | 2.92 | 1.67 | 7.03 | 3.18 | 7.35 | 1.40 | 1.30 | 1.80 | 35.05 |
| 2 | 1.98 | 0.27 | 2.45 | 3.12 | 2.35 | 1.79 | 7.07 | 2.80 | 5.19 | 1.01 | 1.01 | 1.97 | 31.01 |
| 3 | 3.38 | 0.58 | 2.19 | 3.34 | 2.90 | 1.83 | 8.07 | 5.27 | 6.02 | 1.50 | 1.20 | 1.84 | 38.12 |
| 4 | 3.72 | 0.67 | 2.43 | 2.95 | 3.19 | 1.99 | 8.59 | 4.74 | 5.69 | 1.74 | 1.69 | 1.94 | 39.34 |
| 5 | 3.07 | 0.65 | 2.16 | 3.14 | 3.11 | 1.96 | 9.41 | 4.74 | 4.17 | 1.44 | 1.48 | 2.91 | 38.24 |
| 6 | 2.40 | 0.30 | 2.11 | 2.76 | 2.61 | 1.59 | 9.35 | 3.83 | 4.58 | 1.83 | 1.90 | 2.54 | 35.80 |
| 7 | 3.24 | 0.68 | 1.98 | 3.24 | 2.80 | 1.83 | 7.19 | 2.88 | 4.28 | 0.78 | 1.59 | 3.69 | 34.18 |
| 8 | 2.84 | 0.47 | 2.09 | 3.10 | 2.50 | 2.11 | 8.35 | 4.10 | 3.74 | 1.51 | 2.67 | 0.93 | 34.41 |
| 9 | 3.05 | 0.65 | 2.16 | 3.24 | 2.63 | 1.73 | 7.81 | 4.48 | 3.17 | 1.31 | 2.37 | 2.41 | 35.01 |
| 10 | 2.86 | 0.65 | 2.02 | 3.01 | 2.71 | 1.93 | 6.34 | 4.92 | 3.06 | 1.68 | 3.19 | 5.95 | 38.32 |
| 11 | 2.46 | 0.68 | 2.03 | 3.35 | 2.46 | 2.14 | 7.38 | 4.15 | 2.52 | 2.53 | 2.63 | 1.08 | 33.41 |
| 12 | 2.69 | 0.96 | 1.85 | 2.82 | 2.34 | 1.90 | 7.13 | 6.07 | 2.05 | 1.10 | 2.17 | 0.93 | 32.01 |
| 13 | 2.11 | 0.52 | 1.77 | 2.70 | 2.67 | 2.00 | 6.73 | 5.53 | 4.01 | 1.10 | 2.84 | 3.40 | 35.38 |
| 14 | 1.58 | 0.27 | 1.47 | 2.33 | 2.28 | 1.75 | 7.70 | 4.97 | 2.67 | 0.64 | 1.79 | 4.19 | 31.64 |
| 15 | 2.55 | 0.75 | 1.82 | 3.02 | 2.21 | 2.05 | 6.45 | 4.58 | 3.40 | 0.78 | 1.57 | 0.89 | 30.07 |
| 16 | 2.84 | 0.64 | 1.78 | 2.91 | 2.00 | 2.04 | 7.30 | 4.88 | 3.72 | 1.48 | 2.03 | 1.62 | 33.24 |
| 17 | 2.50 | 0.67 | 1.78 | 2.79 | 2.26 | 2.00 | 6.93 | 5.79 | 3.71 | 1.86 | 2.34 | 1.78 | 34.41 |
| 18 | 2.63 | 0.80 | 1.92 | 2.46 | 2.43 | 2.14 | 8.34 | 7.15 | 2.93 | 1.99 | 3.36 | 1.93 | 38.08 |
| 19 | 2.65 | 0.79 | 2.06 | 2.75 | 2.33 | 1.96 | 8.34 | 6.19 | 4.22 | 1.43 | 2.41 | 3.49 | 38.62 |
| 20 | 2.78 | 0.71 | 1.81 | 2.82 | 1.81 | 1.77 | 7.34 | 4.78 | 4.36 | 0.96 | 3.39 | 1.37 | 33.90 |
| 21 | 3.03 | 0.97 | 1.93 | 3.04 | 2.05 | 2.29 | 7.86 | 5.31 | 2.94 | 0.78 | 2.25 | 1.44 | 33.89 |
| 22 | 2.83 | 0.78 | 1.96 | 2.55 | 1.96 | 2.09 | 8.64 | 4.48 | 3.87 | 1.27 | 2.10 | 1.21 | 33.74 |
| 23 | 2.54 | 0.33 | 1.85 | 2.45 | 2.09 | 1.59 | 8.58 | 4.98 | 2.91 | 2.34 | 1.88 | 1.90 | 33.44 |
| 24 | 2.80 | 0.61 | 1.68 | 2.78 | 1.97 | 2.06 | 7.56 | 4.02 | 3.36 | 0.73 | 1.62 | 1.47 | 30.66 |
| 25 | 2.96 | 0.59 | 1.69 | 3.63 | 1.77 | 1.57 | 7.19 | 6.03 | 2.58 | 0.71 | 3.37 | 1.46 | 33.55 |
| Avg | 2.70 | 0.63 | 1.97 | 2.95 | 2.41 | 1.91 | 7.71 | 4.79 | 3.86 | 1.36 | 2.17 | 2.17 | 34.62 |

The 23-year (1990–2012) network average precipitation was 36.77 inches. The Water Year 2013 network average of 34.62 inches was the eighth driest of 24 years of network operation. Water Year 2013 was about 94 percent of both the 23-year network average and the 1981–2010 Chicago O'Hare Airport annual precipitation normal of 36.89 inches. There were 125 precipitation events in Water Year 2013. Seven of the 125 precipitation events included at least one site at which the storm total precipitation exceeded the one-year recurrence interval (Appendix IV). On average, seven heavy precipitation events exceeding the one-year recurrence interval occurred annually in Water Years 1990–2012.

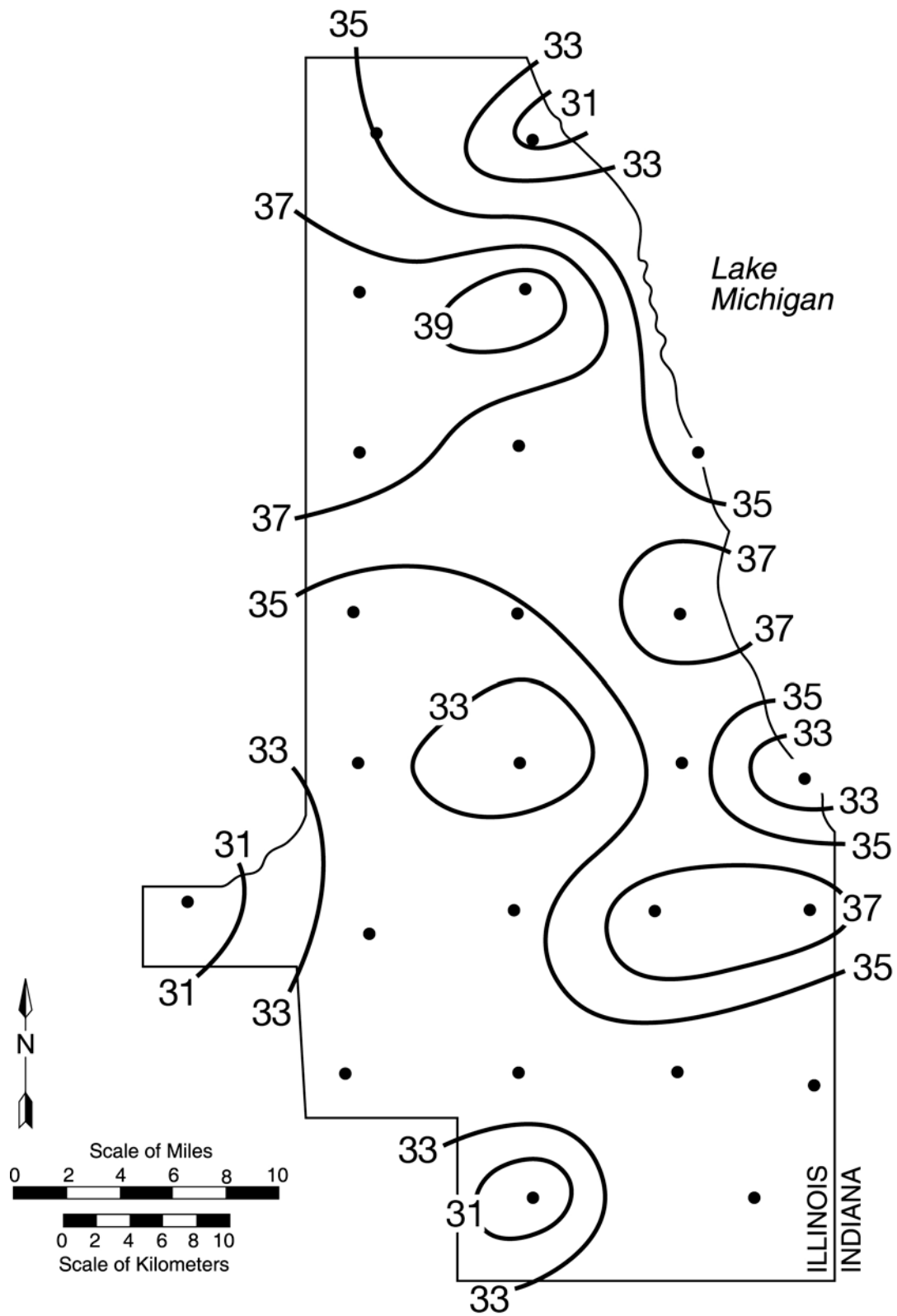

Figure 3. Precipitation pattern (inches) for Water Year 2013

The largest precipitation amounts during Water Year 2013 occurred in the northern and eastern portion of the network (sites #3, #4, #5, #10, #18, and #19, Figure 3). See Figure 2 and Appendix I for site information. The lightest amounts occurred in the southwestern and near-lake portions of the network (sites #12, #15, #24, #2 and #14). The heaviest precipitation in the network during Water Year 2013 fell at site #4 (39.34 inches), while the lightest fell at site #15 (30.07 inches).

As in the case of the other network water year patterns, the spatial pattern for Water Year 2013 (Figure 3) does not contain the anomalies found in an analysis using sites operated by the MWRDGC, the NWS, and Cook County for Water Years 1984–1989 (Vogel, 1988; Pepler, 1993b). Gradients of 15 to 20 inches were common in those analyses. Precipitation data from those sites were the input for diversion accounting before construction of the present network (Pepler, 1993b). For Water Year 2013, there was an 8-inch gradient between Sites #2 and #4. Siting issues may be responsible for this difference. Site #4 is a level and protected location. Changes to Site #2 are under consideration. Site #2 was moved in June 2012 to a protected hillside location. It will be repositioned nearby to a less windy and lower location. These siting differences may accentuate actual precipitation gradients suggested by nearby gages.

Figure 4 provides maps of precipitation amounts for individual Water Years 1990–2012. The general pattern of high values for Water Year 2013 is similar to that for Water Year 2001, with the largest precipitation in the northern region and the lowest precipitation to the south and west.

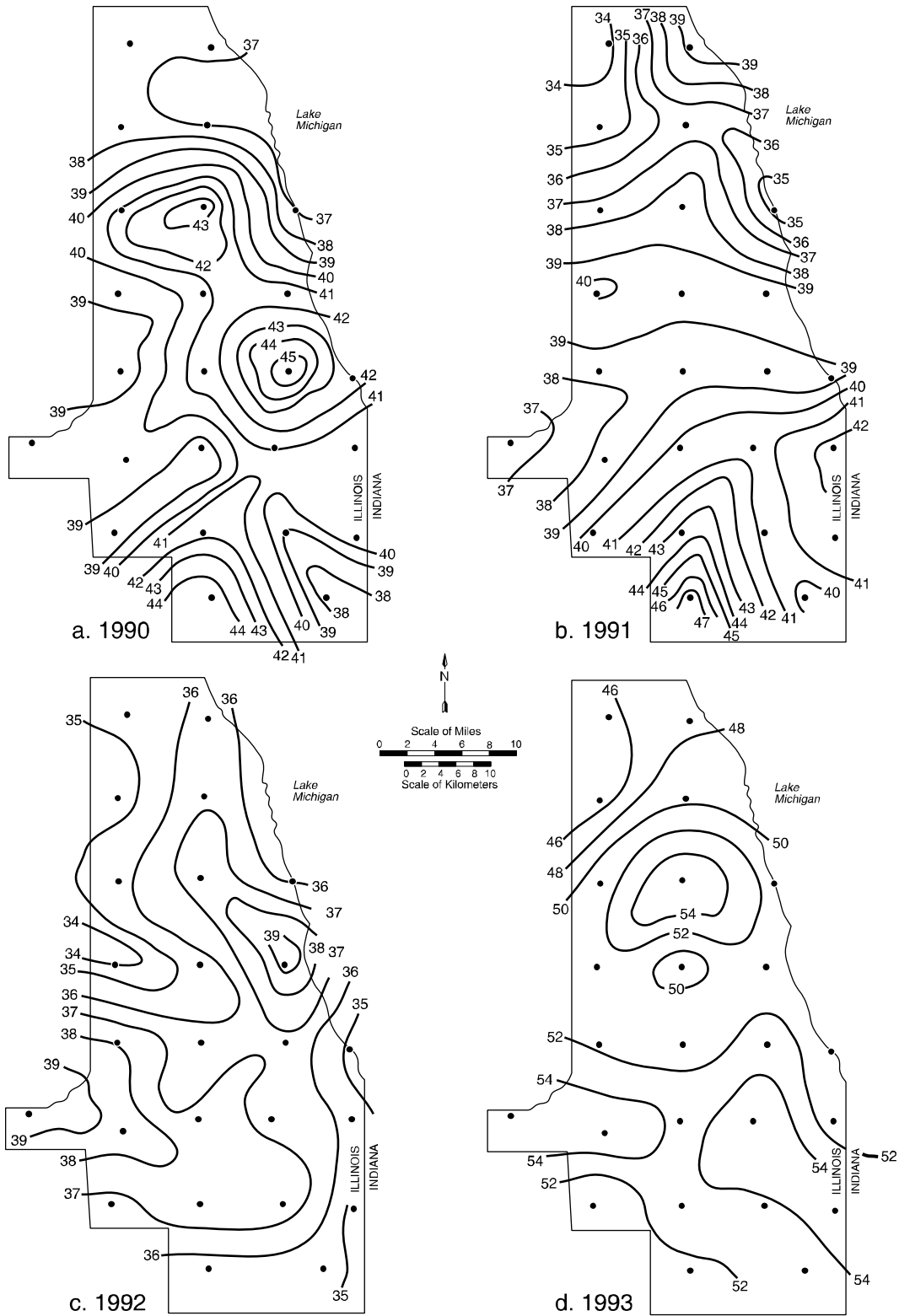

Figure 4. Precipitation pattern (inches) for Water Years 1990–2010

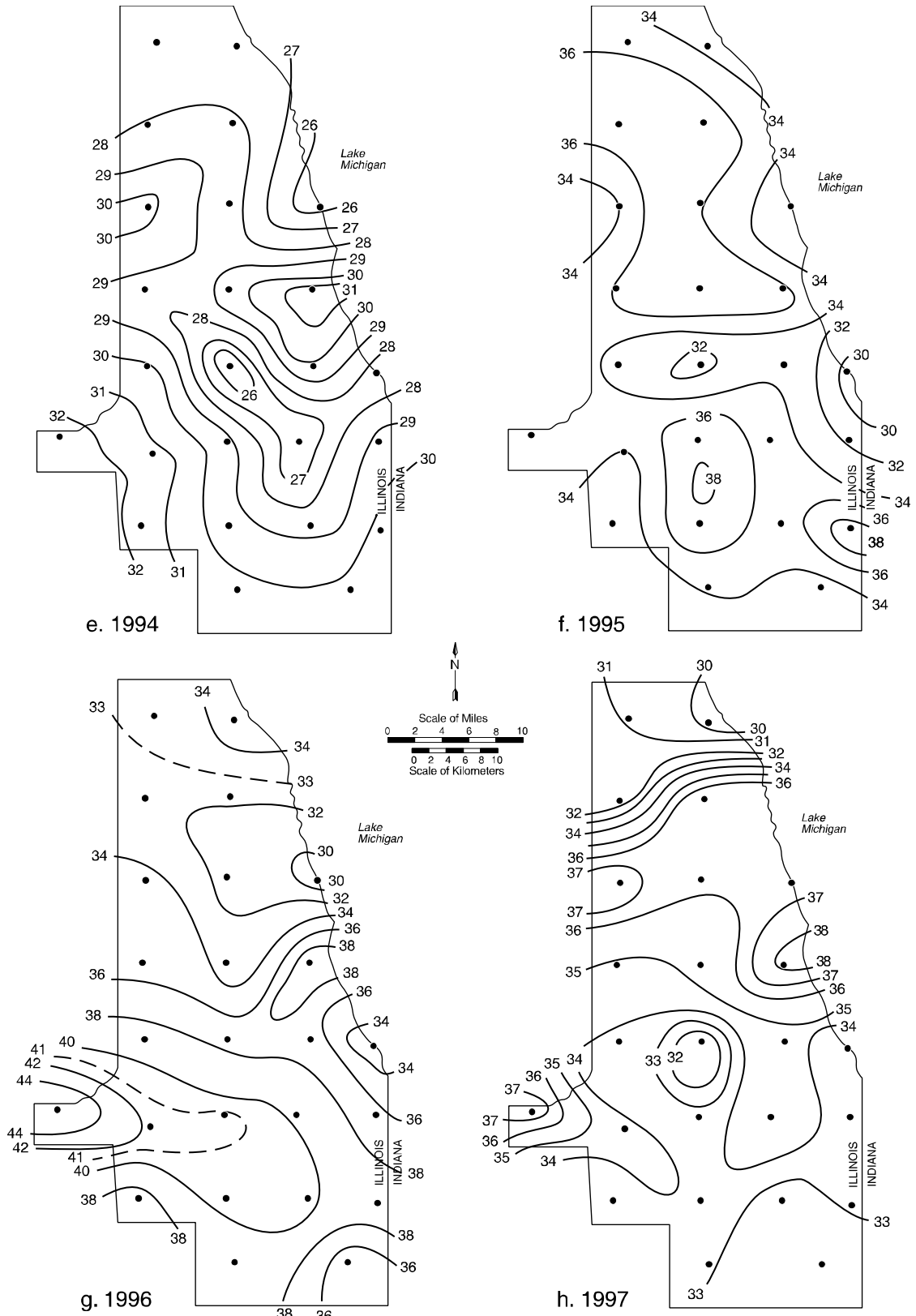

Figure 4. Continued

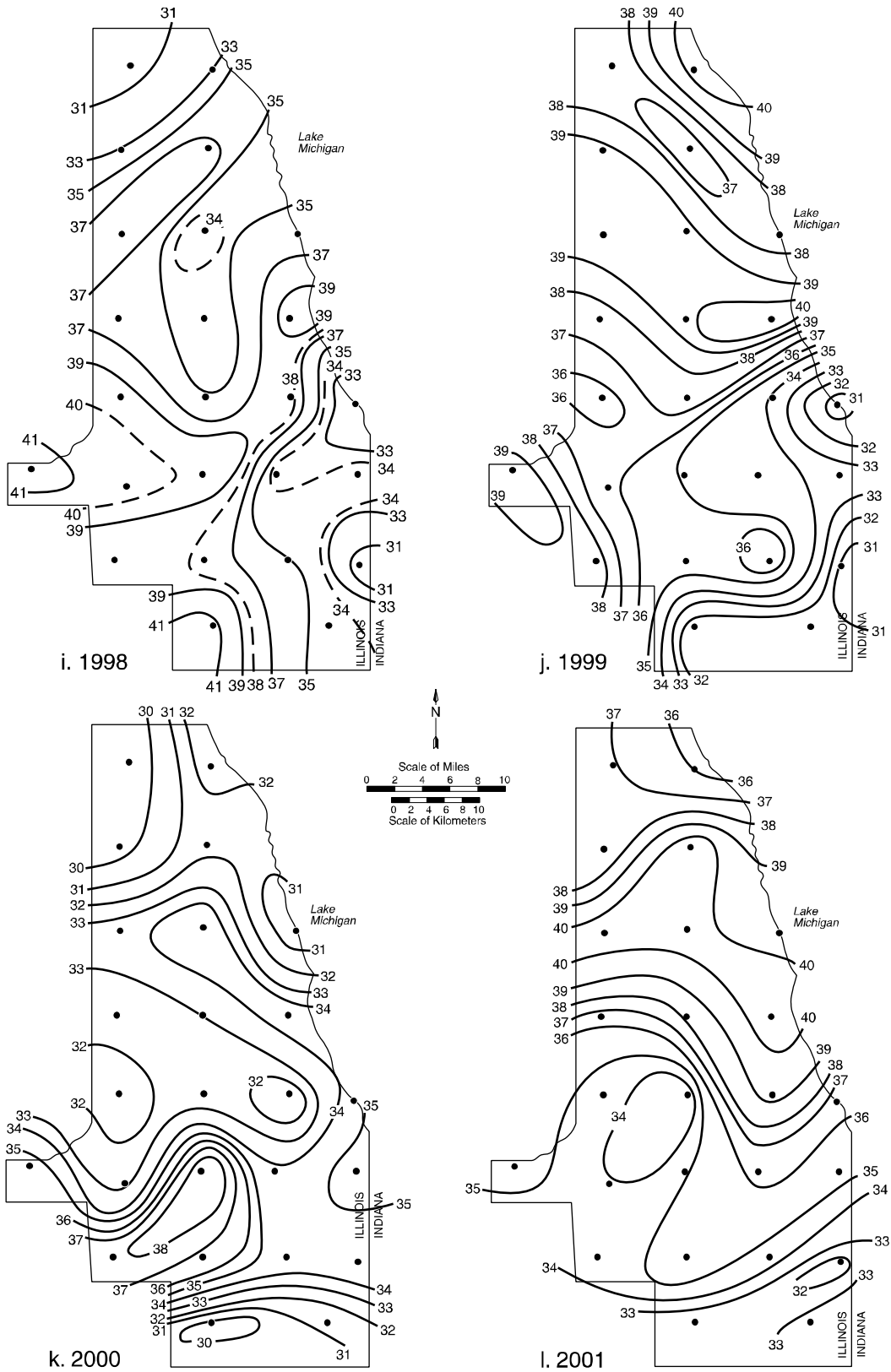

Figure 4. Continued

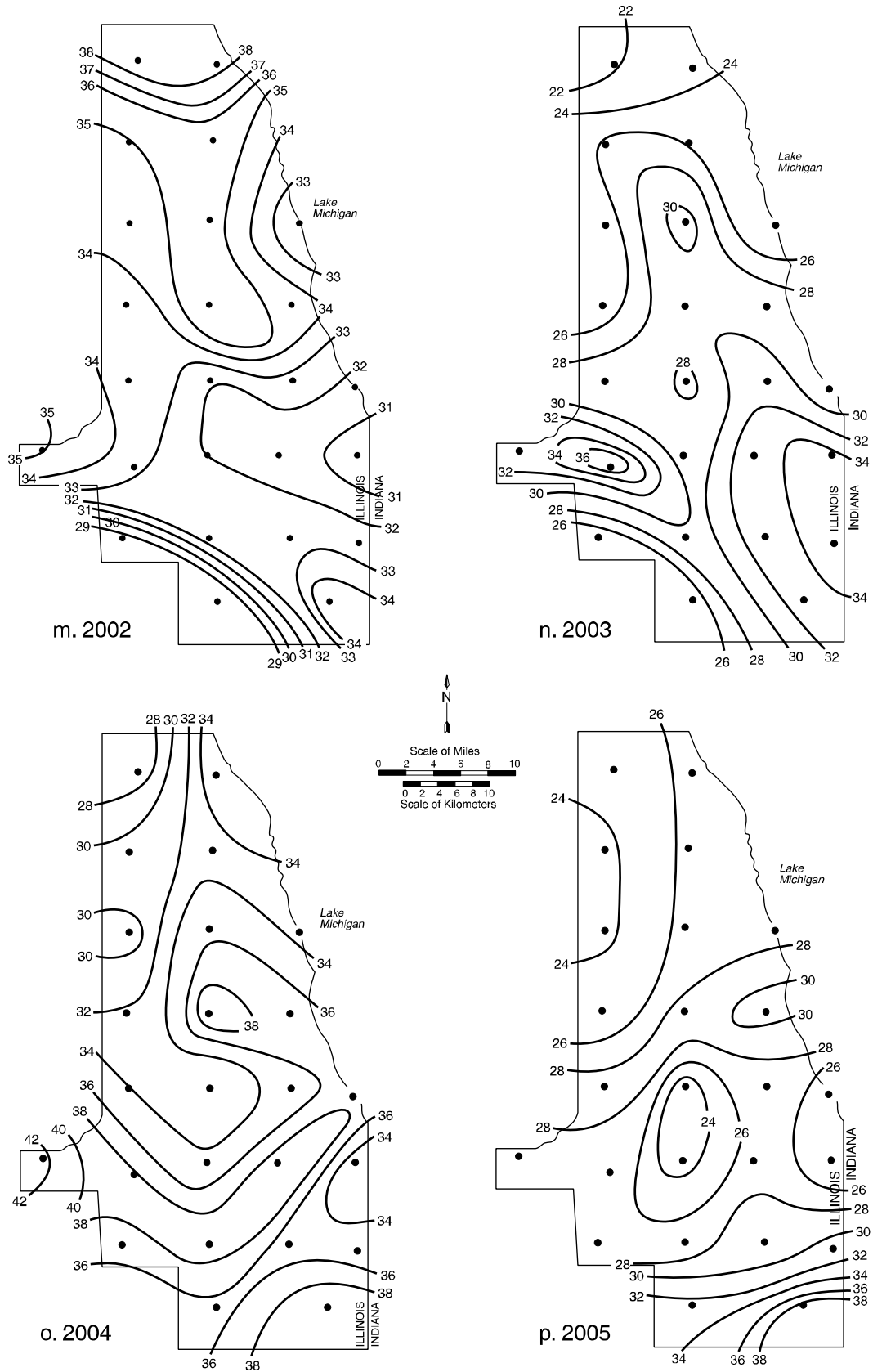

Figure 4. Continued

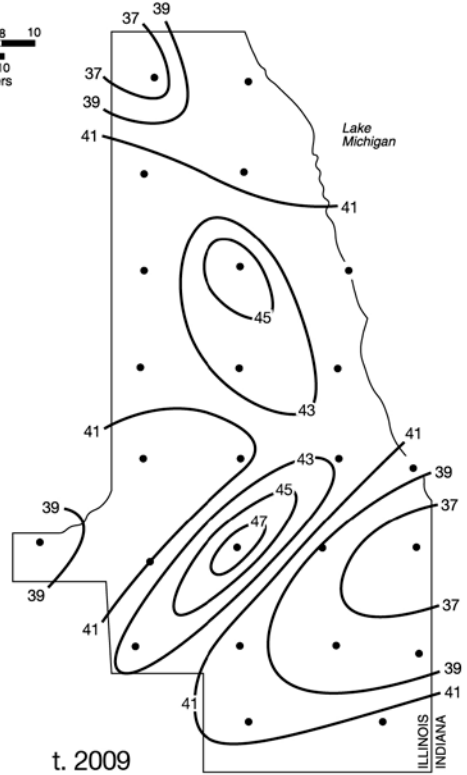
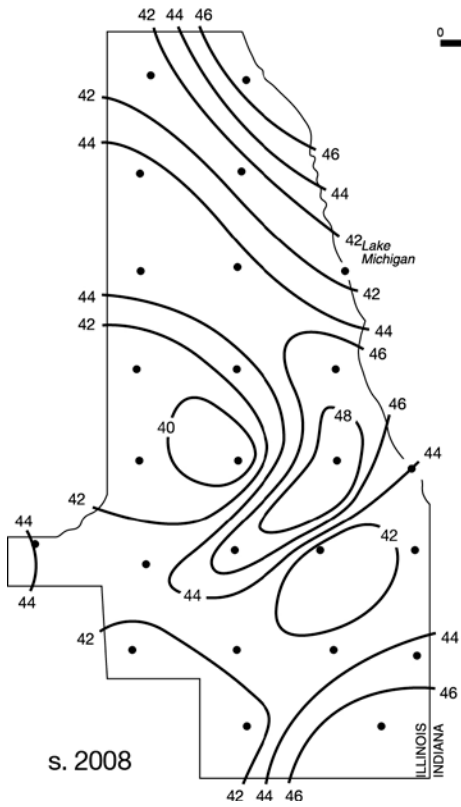
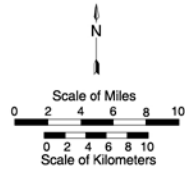
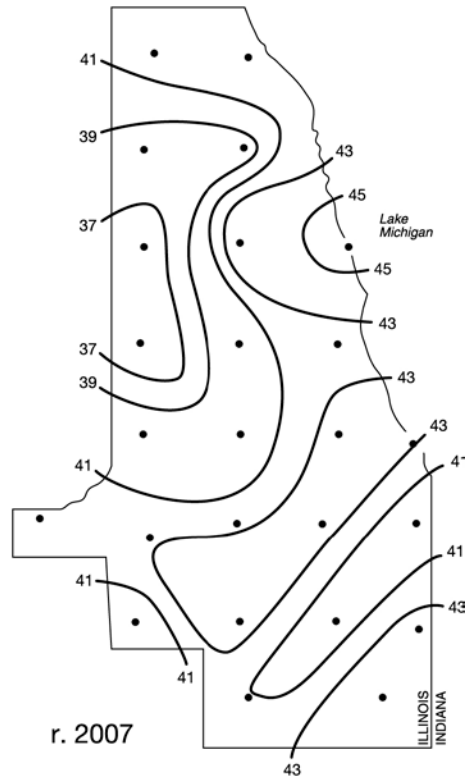
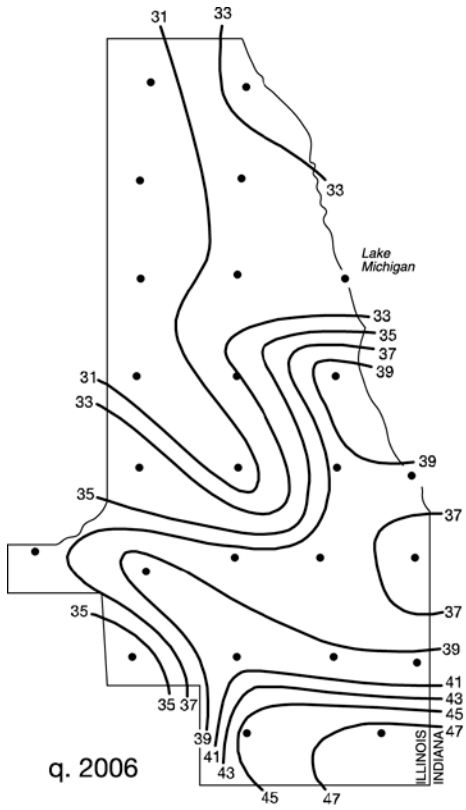

Figure 4. Continued

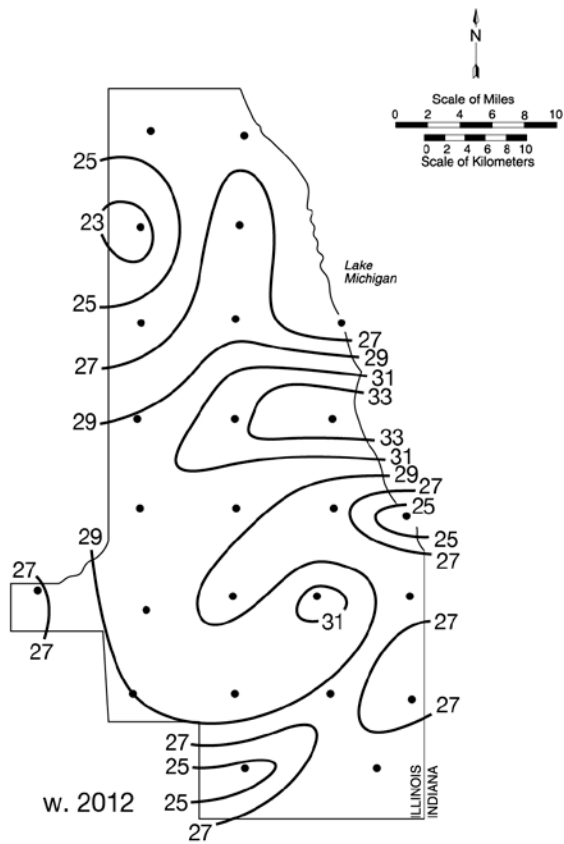
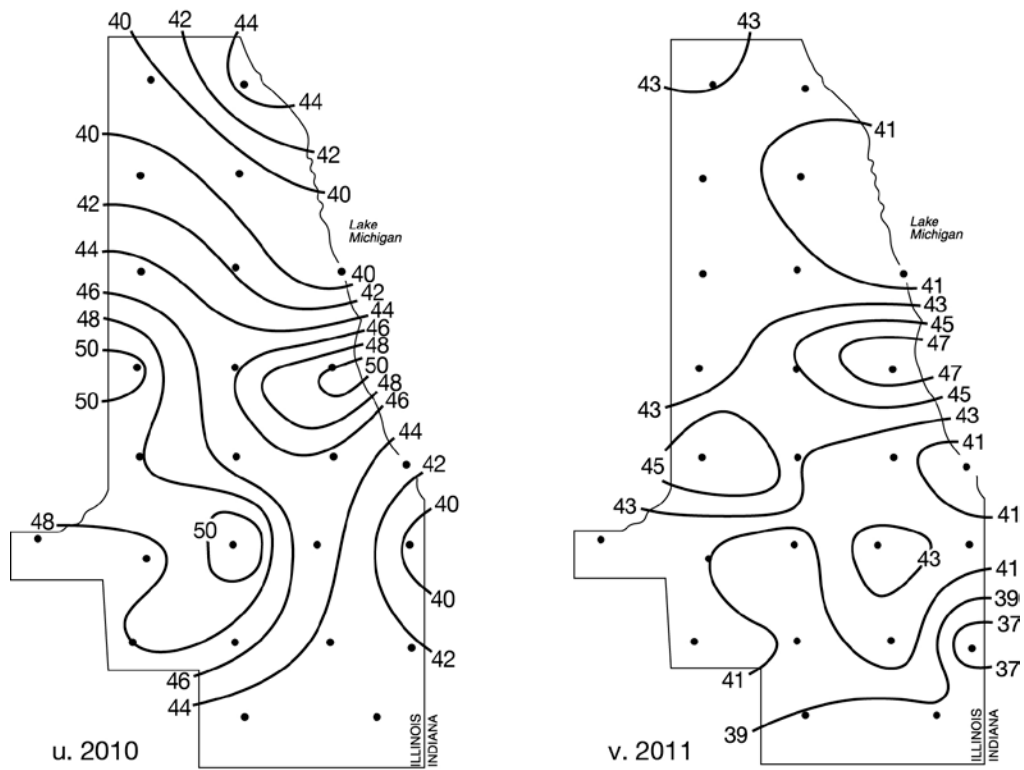

Figure 4. Continued

Figure 5 presents monthly precipitation patterns for Water Year 2013. The April 2013 network precipitation was 220 percent of the 23-year April average precipitation. Monthly network precipitation amounts were 51 percent or less of the 23-year average in November 2012, July 2013, and August 2013. During the other months, network amounts ranged from 71 to 143 percent of normal. Less than 2.0 inches of precipitation fell in November and December 2012, and March and July 2013. More than four inches of precipitation fell in April and May 2013.

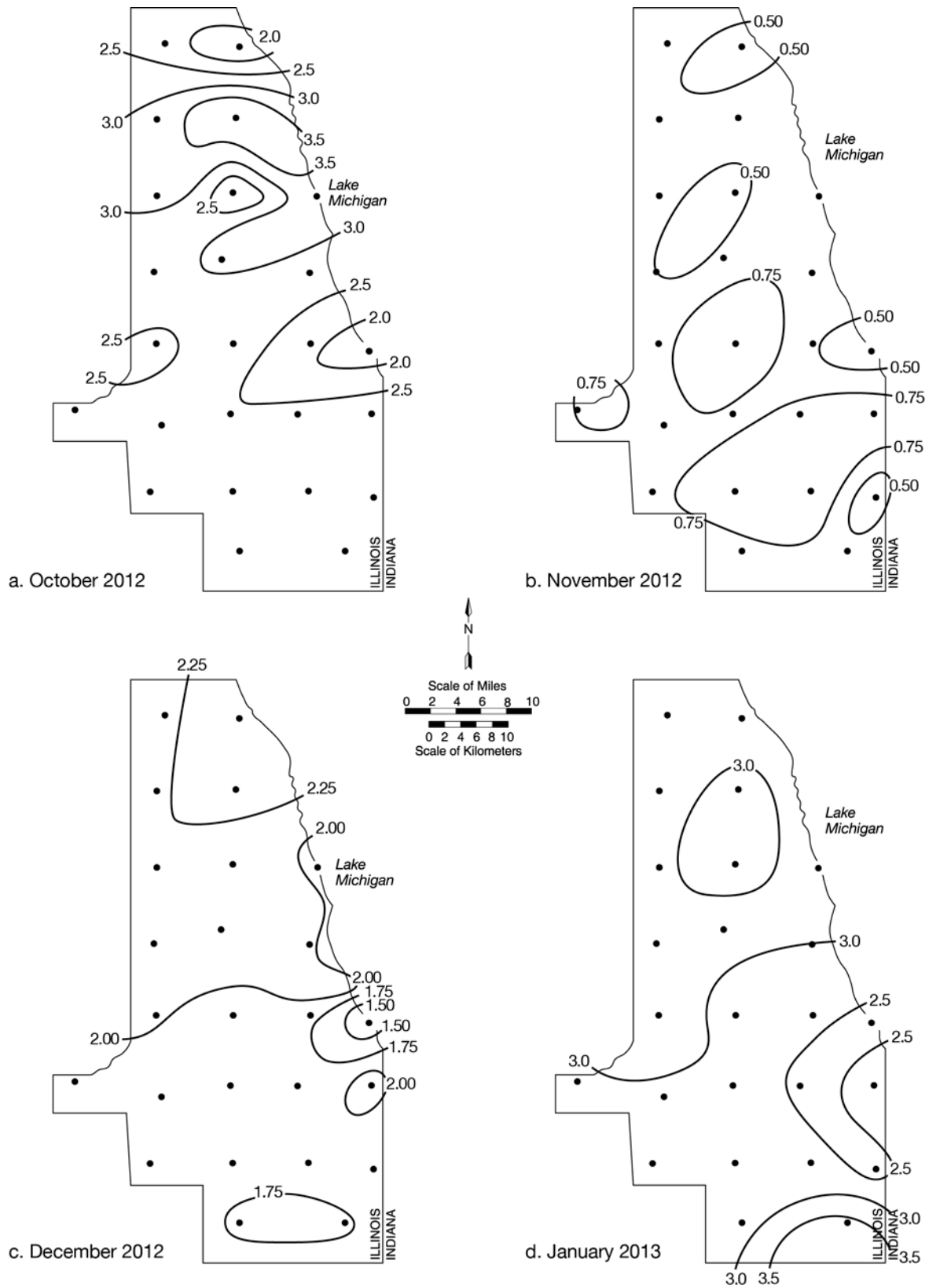

Figure 5. Precipitation pattern (inches) for October 2012–September 2013

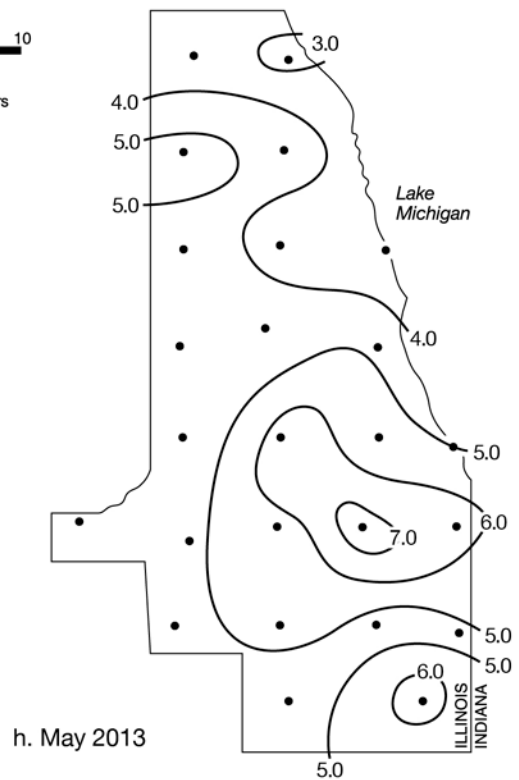
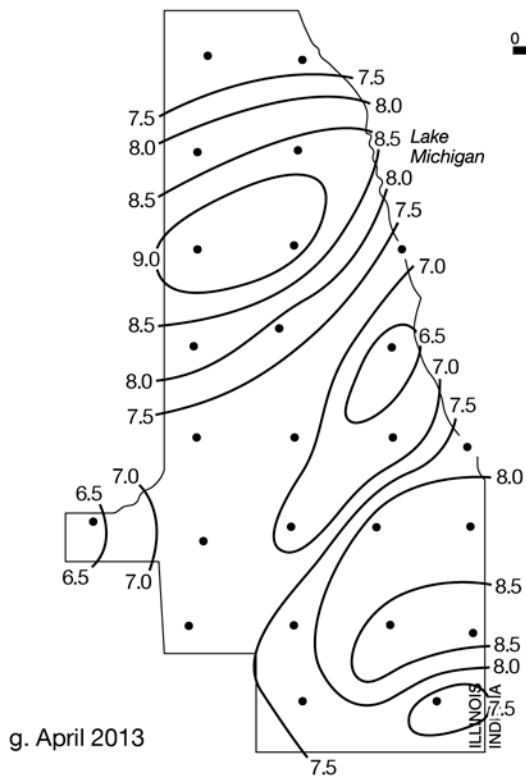
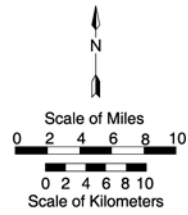
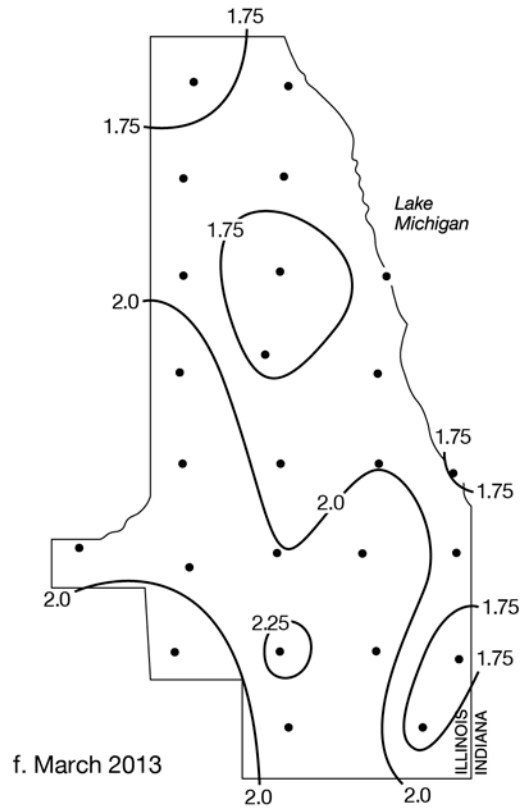
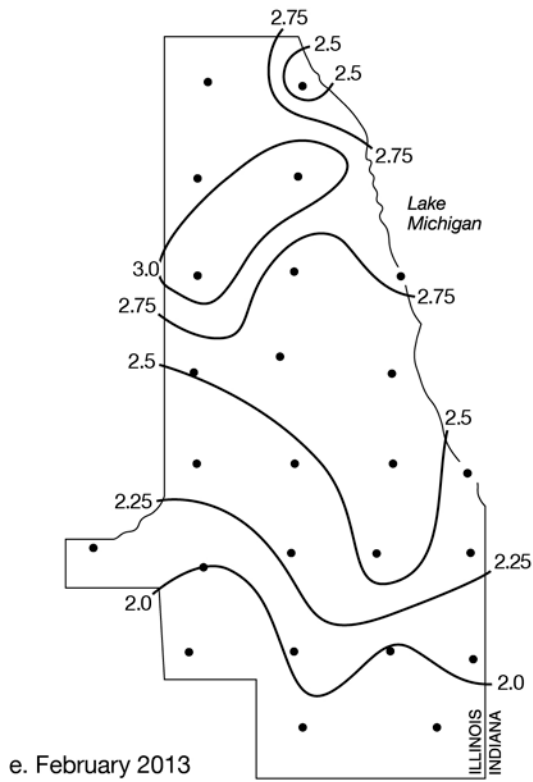

Figure 5. Continued

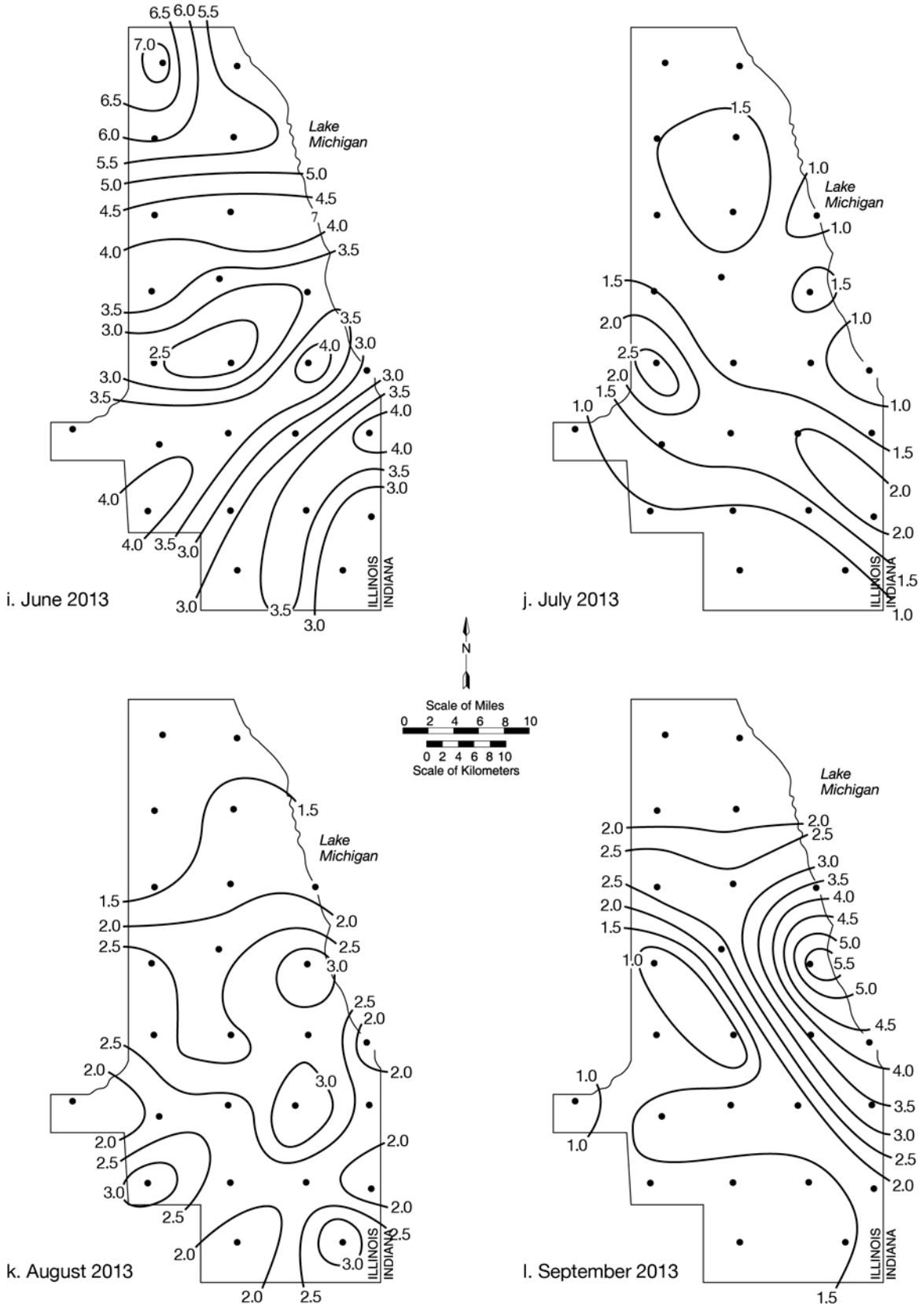

Figure 5. Continued

The 24-year (1990–2013) average precipitation pattern (Figure 6) shows, as in previous years, an area of higher values across southwestern Cook County (sites #15 and #16) and northward to Chicago site #10. Lower values are found at northern sites #1 and #3. The 24-year network-wide average is 36.68 inches.

For high precipitation events, storm durations of one hour to three days were considered, and recurrence intervals were determined according to the standards set for northeastern Illinois (Huff and Angel, 1989). Of the 125 precipitation events identified during Water Year 2013, seven had at least one gage for which the amount surpassed the one-year recurrence interval for the given storm duration. Within these seven storm events, 45 gages exceeded at least the 1-year recurrence interval: 7 gages (the 1-year recurrence interval category), 7 gages (2-year), 12 gages (5-year), 14 gages (10-year), 3 gages (25-year), and 2 gages in the 50-year category. No gages exceed the 100-year recurrence interval.

The seven heavy precipitation events of Water Year 2013 occurred in the spring and summer months. Events with gages exceeding the 25-recurrence interval occurred on April 17-18, 2013, June 26, 2013 and September 18, 2013. Appendix IV contains specific information concerning the Water Year 2013 precipitation events for gages that exceeded the 1-year recurrence interval. It also presents information concerning the four largest storm events that occurred in Cook County the period October 2007 to September 2013.

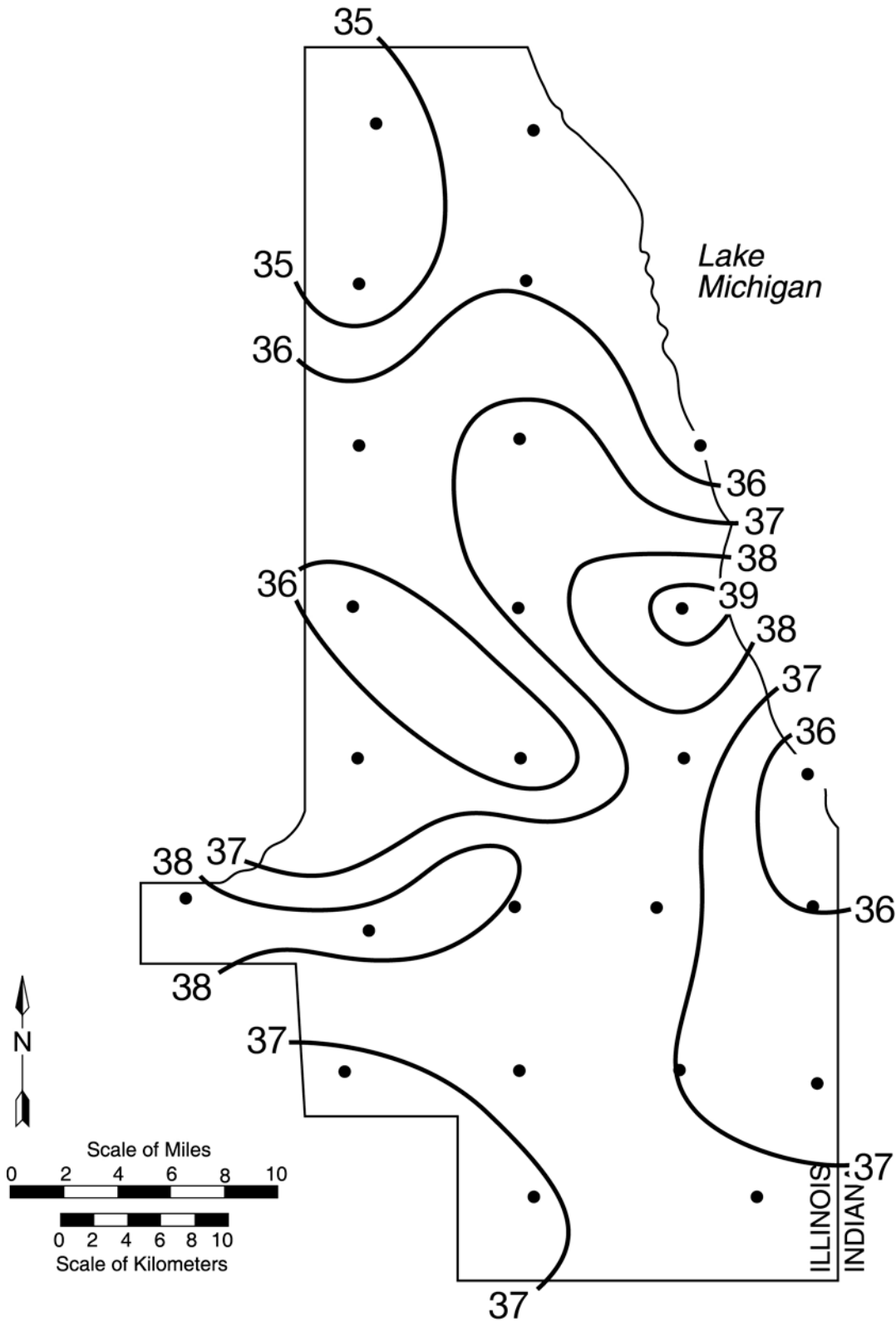

Figure 6. The 24-year average precipitation pattern (inches), Water Years 1990–2013

6. SUMMARY

The Cook County raingage network has collected precipitation data during 24 water years, 1990–2013. The network precipitation average of the 25-gage amounts in Water Year 2013 was 34.62 inches, smaller than the 23-year network average of 36.77 inches (94 percent) and the 1981–2010 Chicago O'Hare Airport annual precipitation normal of 36.89 inches (94 percent). Seven heavy precipitation events occurred during Water Year 2013, with 3 events exceeding the 25-year recurrence interval.

Ten-minute and hourly data can be obtained in real-time via the web at <http://www.isws.illinois.edu/atmos/ccprecipnet/> (select Current Data). Siting of the raingages, areal coverage of the network, installation of potentiometers and data loggers, and careful quality control of the data allow the U.S. Army Corps of Engineers, Chicago District, to accurately estimate the storm runoff portion of the diversion of water from Lake Michigan into Illinois. Because of the relatively dense spacing of the raingages, the network also provides high-quality data for research on precipitation variability of the Cook County region.

7. ACKNOWLEDGMENTS

This material is based upon work supported by the U.S. Army Corps of Engineers, Chicago District, under Contract No. W912P6-08-C-0029. Tzuoh-Ying Su, U.S. Army Corps of Engineers, Chicago District, administered the project. Jim Osborne and Mike Snider service and maintain the gages. Kevin Merrifield was responsible for the web page design, implementation, and maintenance. Sara Olson drafted the figures for this report, and Lisa Sheppard edited the report. Carl Lonquist wrote the distance weighted interpolation program to fill missing hourly data. Any opinions, findings, and conclusions or recommendations expressed in this report are those of the author and do not necessarily reflect the views of the sponsors or the Illinois State Water Survey.

8. REFERENCES

- Changnon, S.A., 1961: Precipitation contrasts between the Chicago urban area and an offshore station in southern Lake Michigan. *Bulletin of the American Meteorological Society*, **42**, 1–10.
- Changnon, S.A., 1968: *Precipitation Climatology of Lake Michigan Basin*. Illinois State Water Survey Bulletin **52**, 46p.
- Changnon, S.A., 1980: Evidence of urban and lake influences on precipitation in the Chicago area. *Journal of Applied Meteorology*, **19**, 1137–1159.
- Changnon, S.A., 1984: Urban and lake effects on summer rainfall in the Chicago area. *Physical Geography*, **4**, 1–23.
- Huff, F.A., 1967: Time distribution of rainfall in heavy storms. *Water Resources Research*, **3**, 1007–1019.
- Huff, F.A., 1970: Sampling errors in measurement of mean precipitation. *Journal of Applied Meteorology*, **9**, 35–44.
- Huff, F.A., 1979: *Spatial and Temporal Correlation of Precipitation in Illinois*. Illinois State Water Survey Circular 141, 14p.
- Huff, F.A., and J.R. Angel, 1989: *Frequency Distributions and Hydroclimatic Characteristics of Heavy Rainstorms in Illinois*. Illinois State Water Survey Bulletin 70, 177p.
- Huff, F.A., and S.A. Changnon, 1973: Precipitation modification by major urban areas. *Bulletin of the American Meteorological Society*, **54**, 1220–1232.
- Huff, F.A., and J.L. Vogel, 1976: *Hydrometeorology of Heavy Rainstorms in Chicago and Northeastern Illinois*. Illinois State Water Survey Report of Investigation 82, 63p.
- Jones, D.M.A., 1969: Effect of housing shape on the catch of recording gages. *Monthly Weather Review*, **97**, 604–606.
- Koschmieder, H., 1934: Methods and results of definite rain measurements. *Monthly Weather Review*, **62**, 5.
- Legates, D.R., and C.J. Willmott, 1990: Mean seasonal and spatial variability in gauge-corrected, global precipitation. *International Journal of Climatology*, **10**, 111–127.
- Lindroth, A., 1991: Reduced loss in precipitation measurements using a new wind shield for raingages. *Journal of Atmospheric and Oceanic Technology*, **8**, 444–451.

- Peppler, R.A., 1990: *Reduction of 1987 Water Year Precipitation Data for Lake Michigan Diversion Accounting*. Illinois State Water Survey Contract Report 498, 16p.
- Peppler, R.A., 1991a: *Reduction and Adjustment of Water Year 1988 and Water Year 1989 Precipitation Data for Lake Michigan Diversion Accounting*. Illinois State Water Survey Contract Report 510, 24p.
- Peppler, R.A., 1991b: *Installation and Operation of a Dense Raingage Network to Improve Precipitation Measurements for Lake Michigan Diversion Accounting: Water Year 1990*. Illinois State Water Survey Contract Report 517, 87p.
- Peppler, R.A., 1991c: *Continued Operation of a Raingage Network for Collection, Reduction, and Analysis of Precipitation Data for Lake Michigan Diversion Accounting: Water Year 1991*. Illinois State Water Survey Contract Report 520, 65p.
- Peppler, R.A., 1993a: *Reduction and Adjustment of 1986 Water Year Precipitation Data for Lake Michigan Diversion Accounting*. Illinois State Water Survey Contract Report 550, 13p.
- Peppler, R.A., 1993b: *Continued Operation of a Raingage Network for Collection, Reduction, and Analysis of Precipitation Data for Lake Michigan Diversion Accounting: Water Year 1992*. Illinois State Water Survey Contract Report 551, 59p.
- Peppler, R.A., 1994: *Continued Operation of a Raingage Network for Collection, Reduction, and Analysis of Precipitation Data for Lake Michigan Diversion Accounting: Water Year 1993*. Illinois State Water Survey Contract Report 573, 60p.
- Peppler, R.A., 1995: *Continued Operation of a Raingage Network for Collection, Reduction, and Analysis of Precipitation Data for Lake Michigan Diversion Accounting: Water Year 1994*. Illinois State Water Survey Contract Report 585, 60p.
- Vogel, J.L., 1986: *Significant Storm Distribution in Chicago, 1949-1979*. Illinois State Water Survey Contract Report 388, 30p.
- Vogel, J.L., 1988: *An Examination of Chicago Precipitation Patterns for Water Year 1984*. Illinois State Water Survey Contract Report 449, 44p.
- Vogel, J.L., 1989: *Reduction of 1985 Water Year Precipitation Data for Chicago*. Illinois State Water Survey Contract Report 459, 15p.

- Westcott, N.E., 1996: *Continued Operation of a Raingage Network for Collection, Reduction, and Analysis of Precipitation Data for Lake Michigan Diversion Accounting: Water Year 1995*. Illinois State Water Survey Contract Report 601, 48p.
- Westcott, N.E., 1997: *Continued Operation of a Raingage Network for Collection, Reduction, and Analysis of Precipitation Data for Lake Michigan Diversion Accounting: Water Year 1996*. Illinois State Water Survey Contract Report 618, 50p.
- Westcott, N.E., 1998: *Continued Operation of a Raingage Network for Collection, Reduction, and Analysis of Precipitation Data for Lake Michigan Diversion Accounting: Water Year 1997*. Illinois State Water Survey Contract Report 628, 51p.
- Westcott, N.E., 1999: *Continued Operation of a Raingage Network for Collection, Reduction, and Analysis of Precipitation Data for Lake Michigan Diversion Accounting: Water Year 1998*. Illinois State Water Survey Contract Report 647, 52p.
- Westcott, N.E., 2000: *Continued Operation of a Raingage Network for Collection, Reduction, and Analysis of Precipitation Data for Lake Michigan Diversion Accounting: Water Year 1999*. Illinois State Water Survey Contract Report 2000-07, 52p.
- Westcott, N.E., 2001: *Continued Operation of a Raingage Network for Collection, Reduction, and Analysis of Precipitation Data for Lake Michigan Diversion Accounting: Water Year 2000*. Illinois State Water Survey Contract Report 2001-02, 52p.
- Westcott, N.E., 2002: *Operation, Maintenance, and Upgrade of a 25-Raingage Network for Collection, Reduction, and Analysis of Precipitation Data for Lake Michigan Diversion Accounting: Water Year 2001*. Illinois State Water Survey Contract Report 2002-03, 57p.
- Westcott, N.E., 2003: *Continued Operation of a 25-Raingage Network for Collection, Reduction, and Analysis of Precipitation Data for Lake Michigan Diversion Accounting: Water Year 2002*. Illinois State Water Survey Contract Report 2003-01, 58p.
- Westcott, N.E., 2004: *Continued Operation of a 25-Raingage Network for Collection, Reduction, and Analysis of Precipitation Data for Lake Michigan Diversion Accounting: Water Year 2003*. Illinois State Water Survey Contract Report 2004-03, 60p.

- Westcott, N.E., 2005: *Continued Operation of a 25-Raingage Network for Collection, Reduction, and Analysis of Precipitation Data for Lake Michigan Diversion Accounting: Water Year 2004*. Illinois State Water Survey Contract Report 2005-01, 62p.
- Westcott, N.E., 2006: *Continued Operation of a 25-Raingage Network for Collection, Reduction, and Analysis of Precipitation Data for Lake Michigan Diversion Accounting: Water Year 2005*. Illinois State Water Survey Contract Report 2006-02, 67p.
- Westcott, N.E., 2007a: *Continued Operation of a 25-Raingage Network for Collection, Reduction, and Analysis of Precipitation Data for Lake Michigan Diversion Accounting: Water Year 2006*. Illinois State Water Survey Contract Report 2007-01, 65p.
- Westcott, N.E., 2007b: *Continued Operation of a 25-Raingage Network for Collection, Reduction, and Analysis of Precipitation Data for Lake Michigan Diversion Accounting: Water Year 2007*. Illinois State Water Survey Contract Report 2007-09, 67p.
- Westcott, N.E., 2009a: *Continued Operation of a 25-Raingage Network for Collection, Reduction, and Analysis of Precipitation Data for Lake Michigan Diversion Accounting: Water Year 2008*. Illinois State Water Survey Contract Report 2009-04, 69p.
- Westcott, N.E., 2009b: Differences in multi-sensor and raingage precipitation amounts. *Proceedings of the Institution of Civil Engineers, Water Management*, **162** (MW2), 73-81.
- Westcott, N.E., 2010: *Continued Operation of a 25-Raingage Network for Collection, Reduction, and Analysis of Precipitation Data for Lake Michigan Diversion Accounting: Water Year 2009*. Illinois State Water Survey Contract Report 2010-03, 68p.
- Westcott, N.E., 2011: *Upgrade and Continued Operation of a 25-Raingage Network for Collection, Reduction, and Analysis of Precipitation Data for Lake Michigan Diversion Accounting: Water Year 2010*. Illinois State Water Survey Contract Report 2011-05, 74p.
- Westcott, N.E., 2012: *Continued Operation of a 25-Raingage Network for Collection, Reduction, and Analysis of Precipitation Data for Lake Michigan Diversion Accounting: Water Year 2011*. Illinois State Water Survey Contract Report 2012-02, 76p.

Westcott, N.E., 2013: *Continued Operation of a 25-Raingage Network for Collection, Reduction, and Analysis of Precipitation Data for Lake Michigan Diversion Accounting: Water Year 2012*. Illinois State Water Survey Contract Report 2013-01, 76p.

Westcott, N.E., H.V. Knapp, and S.D. Hilberg, 2008: Comparison of gage and multi-sensor precipitation estimates over a range of spatial and temporal scales. *Journal of Hydrology*, **351** (1-2), 1–12.

APPENDIX I: RAINGAGE SITE DESCRIPTIONS

This appendix contains site descriptions of the 25 raingage locations (Figure 1) in the network as of September 30, 2013. Sites that have been relocated since the network began operation in October 1989 are noted in the "Placement" section of the descriptions. Note that there are slight differences in latitude and longitude values from previous years. More accurate GPS readings were obtained for all sites during the summer of 2006.

| SITE DESCRIPTION | | |
|---------------------------------------------------------------------------------------------------------------------------------------------------------------------------------------------------------------------------------------------------------------------------------------------------------------------------------------------------------------------------------------|------------------------------------------------|-------------------------------|
| <u>Site Number:</u> 1 | | |
| <u>County:</u> Cook | <u>Township:</u> 42N | <u>Range:</u> 12E |
| <u>Section:</u> 20 | <u>Lat/Long:</u> 42°06'38.85" / 87°52'05.4" | <u>Quadrangle:</u> Park Ridge |
| <u>Property Owner:</u> Mission Brook Sanitary District, Attn: John Tomaras | | |
| <u>Address:</u> P.O. Box 2362, Northbrook, Illinois 60065 | | |
| <u>Telephone:</u> 847/ 272-2956 | | |
| <u>Permission Date:</u> September 14, 1989 | | |
| <u>Installation Date:</u> September 27, 1989 | | |
| <u>Gage Mfrs. No.:</u> 4669 | <u>Gage ID No.:</u> 6561 | |
| <p><u>Placement:</u> On 6-26-99, moved 20 feet north of previous location, which was about 20 feet northwest of pump station at southwest corner of Post and Cornflower Streets. Previously located in southeast corner of pump station lawn through 5-5-97. Tri-State Tollway is just to the west. Enter area from west at Landwehr Road (north of Willow Road) at Sunset Ridge.</p> | | |

| SITE DESCRIPTION | | |
|---------------------------------------------------------------------------------------------------------------------------------------------------------------------------------------------------------------------------------------------------------------------------------------------------------------------------------------------------------------------------------------------------------------------------------------------------------------------------------------------------------------|-----------------------------------------------|-------------------------------|
| <u>Site Number:</u> 2 | | |
| <u>County:</u> Cook | <u>Township:</u> 42N | <u>Range:</u> 13E |
| <u>Section:</u> 19 | <u>Lat/Long:</u> 42°06'26.5" / 87°45'23.9" | <u>Quadrangle:</u> Park Ridge |
| <u>Property Owner:</u> Winnetka Park District, Attn: Henry Michna | | |
| <u>Address:</u> 600 Hibbard Rd, Winnetka, Illinois 60093 | | |
| <u>Telephone:</u> 847/ 501-2056 | | |
| <u>Permission Date:</u> September 14, 1989 | | |
| <u>Installation Date:</u> October 3, 1989 | | |
| <u>Gage Mfrs. No.:</u> 5939 | <u>Gage ID No.:</u> 261 | |
| <p><u>Placement:</u> On hill created by dredge material from irrigation ponds, ¼ mile west of previous location, moved 06/18/2012. Was between office building and chain-link/woven strip fence on grassy strip, established 9-10-97. Previously located 20 feet west, between building and parking lot (from 7-31-91). Previously located 15 feet southeast in yard (from 10-03-89). On workdays, facility closes at 1600 local time. Enter facility from west off Hibbard Street, north of Willow Road.</p> | | |

| SITE DESCRIPTION | | |
|----------------------------------------------------------------------------------------------------------------------|-----------------------------------------------|--------------------------------------|
| <u>Site Number:</u> 3 | | |
| <u>County:</u> Cook | <u>Township:</u> 41N | <u>Range:</u> 12E |
| <u>Section:</u> 28 | <u>Lat/Long:</u> 42°01'21.0" / 87°52'39.9" | <u>Quadrangle:</u> Arlington Heights |
| <u>Property Owner:</u> Private Residence | | |
| <u>Address:</u> 1885 Riverview Avenue, Des Plaines, Illinois 60018 | | |
| <u>Telephone:</u> 708/ 824-1093 | | |
| <u>Permission Date:</u> September 14, 1989 | | |
| <u>Installation Date:</u> September 28, 1989 | | |
| <u>Gage Mfrs. No.:</u> 5940 | <u>Gage ID No.:</u> 5062 | |
| <u>Placement:</u> Northwest corner of the yard by the fence. Enter Riverview Avenue west off Des Plaines River Road. | | |

| SITE DESCRIPTION | | |
|---------------------------------------------------------------------------------------------------------------------------------------------------------------------------------------------------------------------------------------------------------------------------------------------------------------------------------------------------------------------------------------------------------------------------------------------------------------------------------------------------------------------------------------------------------|------------------------------------------------|-------------------------------|
| <u>Site Number:</u> 4 | | |
| <u>County:</u> Cook | <u>Township:</u> 41N | <u>Range:</u> 13 E |
| <u>Section:</u> 21 | <u>Lat/Long:</u> 42°01'38.78 / 87°45'19.61" | <u>Quadrangle:</u> Park Ridge |
| <u>Property Owner:</u> William Novello | | |
| <u>Address:</u> 8047 Floral Avenue, Skokie, Illinois 60077 | | |
| <u>Telephone:</u> 847/ 677-3422 | | |
| <u>Permission Date:</u> June 13, 2011 | | |
| <u>Installation Date:</u> June 13, 2011 | | |
| <u>Gage Mfrs. No.:</u> 4710 | <u>Gage ID No.:</u> 5040 | |
| <u>Placement:</u> Moved 500 feet to northeast to a neighboring backyard, 3 feet west of a fence. Moved ½ block north to east side of backyard of resident (6-13-11). Was on grassy strip between mailbox and village payment box on east side of Floral Street near parking lot, established late 3-94. From 12-92, on west side of Floral Street, 50 feet west of original position, on a grassy strip on east side of Floral Street, 15 feet southwest of current position. All locations are just north of Oakton Street (across from Village Hall). | | |

| SITE DESCRIPTION | | |
|---------------------------------------------------------------------------------------------------------------------------------------------------------------------------------------------------------|-----------------------------------------------|-----------------------------|
| <u>Site Number:</u> 5 | | |
| <u>County:</u> Cook | <u>Township:</u> 40N | <u>Range:</u> 12E |
| <u>Section:</u> 28 | <u>Lat/Long:</u> 41°55'55.3" / 87°52'41.3" | <u>Quadrangle:</u> Elmhurst |
| <u>Property Owner:</u> Private Residence | | |
| <u>Address:</u> 2925 North Sarah Drive, Franklin Park, Illinois 60131 | | |
| <u>Telephone:</u> 708/ 455-2630 | | |
| <u>Permission Date:</u> September 13, 1989 | | |
| <u>Installation Date:</u> September 28, 1989 | | |
| <u>Gage Mfrs. No.:</u> 2267 | <u>Gage ID No.:</u> 5105 | |
| <u>Placement:</u> Northeast corner of backyard near a fence and a hedge. Enter Schiller Avenue east off Mannheim Road, then south on Sarah Drive (one-way). Alley access is also available in the back. | | |

| SITE DESCRIPTION | | |
|---------------------------------------------------------------------------------------------------------------------------------------------------------------------------------------------------------------------------------------------------------------------------------------------------------------------------------------------------------------------------------------------------------------------------------------------------------------------------------------------------------------------------------------------------------------------------------------------------------------------------------------------------------|-----------------------------------------------|---------------------------------|
| <u>Site Number:</u> 6 | | |
| <u>County:</u> Cook | <u>Township:</u> 40N | <u>Range:</u> 13E |
| <u>Section:</u> 28 | <u>Lat/Long:</u> 41°55' 0.4" / 87°45'42.2" | <u>Quadrangle:</u> River Forest |
| <u>Property Owner:</u> Precision Dialogue Direct, attn. Wendell Wilson, Facility Manager | | |
| <u>Address:</u> 611 West Grand Ave, Chicago, Illinois 60634 | | |
| <u>Telephone:</u> 773/ 283-9500 | | |
| <u>Permission Date:</u> September 25, 2013 | | |
| <u>Installation Date:</u> September 25, 2013 | | |
| <u>Gage Mfrs. No.:</u> 4738 | <u>Gage ID No.:</u> 5304 | |
| <u>Placement:</u> Site moved about 2 miles to southeast to a small yard, along 6-foot north of a 6-foot fence, 10 feet south of 35-foot building on 9/25/2013. From 10-2-11 to 8-15-13 in grassing area with 15-foot trees at 30 feet away, at the Chicago Paper and Tube Company. From 7-12-93 to 10-2-11, on the west edge of a backyard 4 feet south of a one-story garage, 15 feet south of a two-story house, and 7 feet northwest of a two-story wooden stairwell/deck. Original location was about 60 feet east-southeast from 9-28-89 through 7-06-93. Chain-link fence. Moved 2 miles northwest to Chicago Paper and Tube Co, on Normandy Ave. | | |

| SITE DESCRIPTION | | |
|-----------------------------------------------------------------------------------------------------------------------------------------------------------------------------------------------------------------------------------------------------------------------------------------------------------------------------------------------------------------------------------------------------------------|------------------------------------------------|---------------------------------|
| <u>Site Number:</u> 7 | | |
| <u>County:</u> Cook | <u>Township:</u> 40N | <u>Range:</u> 14E |
| <u>Section:</u> 21 | <u>Lat/Long:</u> 41°56'35.89" / 87°38'42.3" | <u>Quadrangle:</u> Chicago Loop |
| <u>Property Owner:</u> Broadway United Methodist Church, Attn: Lois Parr, Pastor | | |
| <u>Address:</u> 3344 North Broadway, Chicago, Illinois 60657 | | |
| <u>Telephone:</u> 773/ 348-2679 | | |
| <u>Permission Date:</u> October 4, 1991 | | |
| <u>Installation Date:</u> October 4, 1991 | | |
| <u>Gage Mfrs. No.:</u> 5296 | <u>Gage ID No.:</u> 5303 | |
| <p><u>Placement:</u> Just northeast of parking lot in grass strip between lot and black wrought iron fence. Enter parking lot from Buckingham Place (one-way westbound from Broadway). Was located at Belmont Harbor boat landing (10-01-89 through 12-27-89), on the Lincoln Park Gun Club roof (12-27-89 through 06-28-91), and just north of Diversey Harbor in a playground (6-28-91 through 10-04-91).</p> | | |

| SITE DESCRIPTION | | |
|--------------------------------------------------------------------------------------------------------------------------------------------------------------------------------------------------------------------------------------------------------------------------------------------------------------------------------------------------------------------------------------------------------------|-----------------------------------------------|-----------------------------|
| <u>Site Number:</u> 8 | | |
| <u>County:</u> Cook | <u>Township:</u> 39N | <u>Range:</u> 12E |
| <u>Section:</u> 29 | <u>Lat/Long:</u> 41°50'41.1" / 87°52'55.6" | <u>Quadrangle:</u> Hinsdale |
| <u>Property Owner:</u> Forest Preserve District of Cook County, Attn: William Granberry | | |
| <u>Address:</u> 536 N. Harlem Avenue, River Forest, Illinois 60305 | | |
| <u>Telephone:</u> 708/ 771-1059 | | |
| <u>Permission Date:</u> September 21, 1989 | | |
| <u>Installation Date:</u> September 27, 1989 | | |
| <u>Gage Mfrs. No.:</u> 4705 | <u>Gage ID No.:</u> 5070 | |
| <p><u>Placement:</u> Just south of Forest Preserve entrance road, on the west side of Forest Preserve property. Through 12-11-97, 300 feet to east-southeast in southeast corner of backyard between pool and grape hedge. On 20 May 2010 moved 3 feet west to sunnier location. Enter Windsor Drive east from Belleview Drive, south from Cermak Road. Just west of Salt Creek and parallel bike trail.</p> | | |

| SITE DESCRIPTION | | |
|-------------------------------------------------------------------------------------------------------------------------------------------------------------------------------------------------------------------------------------------------------------------------------------------------------------------------------------------------------------------------------------------------------------------------------------------------------------------------------------------------------------------------------------------------------------------------------------------------------------------------------------------------------------------------------------------------------------------------------------------------------------------------------------------------------------------------------------------------------------------------------------------|-------------------------------------------------|-----------------------------|
| <u>Site Number:</u> 9 | | |
| <u>County:</u> Cook | <u>Township:</u> 39E | <u>Range:</u> 13E |
| <u>Section:</u> 28 | <u>Lat/Long:</u> 41°51'54.19" / 87°45'16.87" | <u>Quadrangle:</u> Oak Park |
| <u>Property Owner:</u> Mr. Lido Manetti, Water Department Director, City of Cicero | | |
| <u>Address:</u> 4949 West Cermak Road, Cicero, IL 60804 | | |
| <u>Telephone:</u> 708 / 656-3600 Ext. 164 | | |
| <u>Permission Date:</u> March 14, 2011 | | |
| <u>Installation Date:</u> March 14, 2011 | | |
| <u>Gage Mfrs. No.:</u> 5303 | <u>Gage ID No.:</u> 6559 | |
| <p><u>Placement:</u> Returned to Cicero Water Station (Laramie) in southeast corner of lot (3-14-2011). Moved 1.5 miles northeast of previous location to Columbia Park Golf Course to 10 feet south of one-story shed on east border of driving range, 8-11-08. Moved 2 miles west to backyard of residence, 10 feet west of 1.5-story house and 30 feet east of one-story garage, 9-18-05. Was at Cicero Water Station on Roosevelt Drive, 0.5 miles east of previous location, in center of 50- by 100-foot grassy lot, 50 feet west of 20-foot water tank (6-7-2002). Was at Cicero Water Station 1.3 miles (Roosevelt and Laramie) north of previous location (through 7-1-01). Was on southwest corner of schoolyard, 12 feet from south fence line and along west fence, west of the nunnery (through 4-9-98). Was located at 5530 West 24th Street (9-28-89 through 5-24-89).</p> | | |

| SITE DESCRIPTION | | |
|----------------------------------------------------------------------------------------------------------------------------------------------------------------------------------------------------------------------------------------------------------------------------|-----------------------------------------------|------------------------------|
| <u>Site Number:</u> 10 | | |
| <u>County:</u> Cook | <u>Township:</u> 39N | <u>Range:</u> 14E |
| <u>Section:</u> 28 | <u>Lat/Long:</u> 41°50'42.5" / 87°38'28.1" | <u>Quadrangle:</u> Englewood |
| <u>Property Owner:</u> Rental Residence | | |
| <u>Address:</u> 527 West 26th Street, Chicago, Illinois 60616 | | |
| <u>Telephone:</u> 312/ 225-8066 | | |
| <u>Permission Date:</u> September 13, 1989 | | |
| <u>Installation Date:</u> September 28, 1989 | | |
| <u>Gage Mfrs. No.:</u> 3342 | <u>Gage ID No.:</u> 5113 | |
| <p><u>Placement:</u> Backyard near edge of walk north of a garage and was east of a spruce tree (removed in 2004). Enter off alley south of 26th Street, where locked gate is to be entered (observer keeps key). In Chinatown area, block between Wallace and Normal.</p> | | |

| SITE DESCRIPTION | | |
|-----------------------------------------------------------------------------------------------------------------------------------------------------------------------------------------------------------------------------------------------------------------------------------------------------------------------------------------------------------------------------------|-----------------------------------------------|---------------------------|
| <u>Site Number:</u> 11 | | |
| <u>County:</u> Cook | <u>Township:</u> 38N | <u>Range:</u> 12E |
| <u>Section:</u> 28 | <u>Lat/Long:</u> 41°45'31.8" / 87°53'20.2" | <u>Quadrangle:</u> Berwyn |
| <u>Property Owner:</u> Edgewood Valley Country Club, Attn: Ronald B. McCarthy, Superintendent | | |
| <u>Address:</u> 7500 S. Willow Springs Road, LaGrange, Illinois 60525 | | |
| <u>Telephone:</u> 708/ 246-2800 | | |
| <u>Permission Date:</u> April 18, 2002 | | |
| <u>Installation Date:</u> April 18, 2002 | | |
| <u>Gage Mfrs. No.:</u> 5947 | <u>Gage ID No.:</u> 4452 | |
| <u>Placement:</u> Moved 0.25 miles to Edgewood Country Club (4-18-02). Site on north end at highest elevation of golf course, about 60 feet from fence line separating the club from the 294 Tollway. Was in center of backyard near edge of large garden, accessed from Willow Springs Road, south of Joliet Road on parcel of land between Interstate-55 and Tri-State Tollway. | | |

| SITE DESCRIPTION | | |
|-------------------------------------------------------------------------------------------------------------------------------------------------------------------------------------------------------------------------------------------------------------------------------------------------------------------------------------------------------------------------------------------------------------------------------------|-----------------------------------------------|---------------------------|
| <u>Site Number:</u> 12 | | |
| <u>County:</u> Cook | <u>Township:</u> 38N | <u>Range:</u> 13E |
| <u>Section:</u> 28 | <u>Lat/Long:</u> 41°45'30.7" / 87°46'06.8" | <u>Quadrangle:</u> Berwyn |
| <u>Property Owner:</u> HallStar, Attn: Garrett Drozd | | |
| <u>Address:</u> 5851 West 73rd Street, Bedford Park, Illinois 60638 | | |
| <u>Telephone:</u> 708/ 594-5063 | | |
| <u>Permission Date:</u> November 24, 1992 | | |
| <u>Installation Date:</u> November 24, 1992 | | |
| <u>Gage Mfrs. No.:</u> 5985 | <u>Gage ID No.:</u> 5111 | |
| <u>Placement:</u> Moved to a small incline close to a 6-foot chain-link security fence on 9-11-97. Previously 10 feet to northeast along same service drive in mowed grassy area (9-17-93 through 9-11-97). Previously about 400–500 feet to the northeast in a large grassy area north of office building (11-24-92 through 5-17-93). Prior to 11-24-92, gage was at Reckitt and Coleman about 0.9 miles east of present location. | | |

| SITE DESCRIPTION | | |
|-------------------------------------------------------------------------------------------------------------------------------------------------------------------------------------------------------------------------------------------------------------------------------------------------------------------------------------------------------------------------------------------------------------------------------------------------------------------------------------|-----------------------------------------------|------------------------------|
| <u>Site Number:</u> 13 | | |
| <u>County:</u> Cook | <u>Township:</u> 38N | <u>Range:</u> 14E |
| <u>Section:</u> 28 | <u>Lat/Long:</u> 41°45'30.1" / 87°38'29.9" | <u>Quadrangle:</u> Englewood |
| <u>Property Owner:</u> Greune Coal Company, Attn: Paul Schoeing | | |
| <u>Address:</u> 7435 South Union Street, Chicago, Illinois 60621 | | |
| <u>Telephone:</u> 773/ 846-4000 | | |
| <u>Permission Date:</u> March 1, 1995 | | |
| <u>Installation Date:</u> March 15, 1995 | | |
| <u>Gage Mfrs. No.:</u> 3771 | <u>Gage ID No.:</u> 5058 | |
| <u>Placement:</u> It is currently placed on top of a 6 foot dividing wall. Was about 7 feet from the 10-foot wall and 30 feet from the 25-foot-tall elevated-train retaining wall (5-3-99). In southwest corner of property north of an elevated railroad track and east of a concrete barrier. Access is from south on Union Street (one-way north) north of 76th Street. Location is about four blocks due west of original position (09-29-89 to 03-15-95) in Mrs. Wolfe's yard. | | |

| SITE DESCRIPTION | | |
|-----------------------------------------------------------------------------------------------------------------------------------------------------------------------------------------------------------------------------------------------|-----------------------------------------------|---------------------------------|
| <u>Site Number:</u> 14 | | |
| <u>County:</u> Cook | <u>Township:</u> 38N | <u>Range:</u> 15E |
| <u>Section:</u> 29 | <u>Lat/Long:</u> 41°45'27.2" / 87°32'37.9" | <u>Quadrangle:</u> Jackson Park |
| <u>Property Owner:</u> City of Chicago - South Water Purification Plant, Attn: Chief Engineer, Diane Cardella Assistant Chief Filtration Engineer | | |
| <u>Address:</u> 3300 East Chilternham Place, Chicago, Illinois 60649 | | |
| <u>Telephone:</u> 312/ 747-0382 | | |
| <u>Permission Date:</u> September 12, 1989 | | |
| <u>Installation Date:</u> September 28, 1989 | | |
| <u>Gage Mfrs. No.:</u> 2000 | <u>Gage ID No.:</u> 4453 | |
| <u>Placement:</u> Snow shield installed, 10-9-96. Center of large grassy area (turf-covered roof) over sand filtration beds. Two distant buildings are east and west of the site. Enter facility east off 79th Street from South Shore Drive. | | |

| SITE DESCRIPTION | | |
|--------------------------------------------------------------------------------------------------------------------------------------------------------------------------------------------------------------------------------------------------------------------------------------------------------------------------------------------------------------------------------------------------------------------|-----------------------------------------------|-------------------------------|
| <u>Site Number:</u> 15 | | |
| <u>County:</u> Cook | <u>Township:</u> 37N | <u>Range:</u> 11E |
| <u>Section:</u> 20 | <u>Lat/Long:</u> 41°40'45.9" / 87°57'54.4" | <u>Quadrangle:</u> Sag Bridge |
| <u>Property Owner:</u> St. Mary's Seminary, c/o Fr. Vendelin | | |
| <u>Address:</u> 14246 Main Street, P.O. Box 608, Lemont, Illinois 60439 | | |
| <u>Telephone:</u> 630/ 257-2494 | | |
| <u>Permission Date:</u> November 11, 1994 | | |
| <u>Installation Date:</u> November 22, 1994 | | |
| <u>Gage Mfrs. No.:</u> 5935 | <u>Gage ID No.:</u> 4421 | |
| <u>Placement:</u> About 250 feet along west side of a lane that extends southeasterly from the main building and drive-around, in a clearing. Previous original position (09-27-89 to 11-22-94) was at the MWRDGC site in downtown Lemont about 1.5 miles west of present position. Entrance lane is south off Main Street. Exit Interstate-55 south on Lemont Road to downtown, then proceed east on Main Street. | | |

| SITE DESCRIPTION | | |
|----------------------------------------------------------------------------------------------------------------------------------------------------------------------------------------------------------------------------------------------------------------------------------------|-----------------------------------------------|-------------------------------|
| <u>Site Number:</u> 16 | | |
| <u>County:</u> Cook | <u>Township:</u> 37N | <u>Range:</u> 12E |
| <u>Section:</u> 28 | <u>Lat/Long:</u> 41°39'47.4" / 87°52'13.5" | <u>Quadrangle:</u> Palos Park |
| <u>Property Owner:</u> Private Residence | | |
| <u>Address:</u> 240 Timber Edge Lane, Palos Park, Illinois 60464 | | |
| <u>Telephone:</u> 708/ 361-0853 | | |
| <u>Permission Date:</u> September 11, 1989 | | |
| <u>Installation Date:</u> September 27, 1989 | | |
| <u>Gage Mfrs. No.:</u> 5283 | <u>Gage ID No.:</u> 5022 | |
| <u>Placement:</u> Along west edge of lawn in backyard, about 20 feet south of property line and utility. Was moved about 2 feet on 4-26-91 to facilitate landscaping. Enter subdivision from 125th Street (off Route 45), just south of McCarthy Road. West-southwest of Papoose Lake. | | |

| SITE DESCRIPTION | | |
|------------------------------------------------------------------------------------------------------------------------------------------------------------------------------------------------------------------------------------------------------------------------------------------------------------------------------------------------------------------------|-----------------------------------------------|-------------------------------|
| <u>Site Number:</u> 17 | | |
| <u>County:</u> Cook | <u>Township:</u> 37N | <u>Range:</u> 13E |
| <u>Section:</u> 28 | <u>Lat/Long:</u> 41°40'30.1" / 87°45'00.0" | <u>Quadrangle:</u> Palos Park |
| <u>Property Owner:</u> Alsip Fire Department Station #2, Attn: Lt. John Solum | | |
| <u>Address:</u> 11946 South Laramie Street, Alsip, Illinois 60482 | | |
| <u>Telephone:</u> 708/ 385-6902 | | |
| <u>Permission Date:</u> August 9, 1994 | | |
| <u>Installation Date:</u> August 9, 1994 | | |
| <u>Gage Mfrs. No.:</u> 5284 | <u>Gage ID No.:</u> 5415 | |
| <u>Placement:</u> Just north of parking lot west of (behind) Alsip Fire Department Station #2 building. Present location is about 150 yards south-southeast of previous original position (9-27-89 to 08-09-94) at Sardee Industries. Enter Laramie Street north from 122nd Street, west of Cicero Avenue. Northeast of Tri-State Tollway, south of Restvale Cemetery. | | |

| SITE DESCRIPTION | | |
|-------------------------------------------------------------------------------------------------------------------------------------------------------------------------------------------------------------------------------------------------------------------------------------------------------------------------------------------------------------------------------------------|-----------------------------------------------|--------------------------------|
| <u>Site Number:</u> 18 | | |
| <u>County:</u> Cook | <u>Township:</u> 37N | <u>Range:</u> 14E |
| <u>Section:</u> 29 | <u>Lat/Long:</u> 41°40'40.9" / 87°39'04.4" | <u>Quadrangle:</u> Blue Island |
| <u>Property Owner:</u> AxleTech International, Attn: Mr. Mike Newman | | |
| <u>Address:</u> 9420 S. Stoney Island, Chicago, Illinois 60617 | | |
| <u>Telephone:</u> 773/ 264-1234, ext. 552 (Jay R. Litcher) | | |
| <u>Permission Date:</u> March 5, 2003 | | |
| <u>Installation Date:</u> March 5, 2003 | | |
| <u>Gage Mfrs. No.:</u> 5279 | <u>Gage ID No.:</u> None | |
| <u>Placement:</u> Moved about 600 feet north-northeast to Heat Treat at 1120 West 119th St., and is in the center of a fenced area south of employee parking, from old location at Ingersol, on 3-6-2003. Was at west end of property just northwest of a truck scale and east of property fence. Gage moved about 150 feet north of original position, within same property, on 8-09-94. | | |

| SITE DESCRIPTION | | |
|------------------------------------------------------------------------------------------------------------------------------------------------------------------------------------------------------------------------------------------------------------------------------------------------------------------------------------------------------------------------------------------------------------|-------------------------------------------------|---------------------------------|
| <u>Site Number:</u> 19 | | |
| <u>County:</u> Cook | <u>Township:</u> 37N | <u>Range:</u> 15E |
| <u>Section:</u> 20 | <u>Lat/Long:</u> 41°40'44.39" / 87°32'23.00" | <u>Quadrangle:</u> Lake Calumet |
| <u>Property Owner:</u> Gallo Equipment, Robert Gallo | | |
| <u>Address:</u> 11835 South Avenue O, Chicago, Illinois 60633 | | |
| <u>Telephone:</u> 773 / 374- 5515 | | |
| <u>Permission Date:</u> June 30, 2011 | | |
| <u>Installation Date:</u> July 14, 2011 | | |
| <u>Gage Mfrs. No.:</u> 4718 | <u>Gage ID No.:</u> 5291 | |
| <p><u>Placement:</u> Located 0.45 miles north of previous location, 7-14-11. Was in grassy area just north of a shop building and just south of entrance drive, established on 11-24-92. Previous original position was 50 feet due east in a grassy area just south of entrance drive and just west of the main parking lot. A factory building is located 50 feet north-northeast of both locations.</p> | | |

| SITE DESCRIPTION | | |
|------------------------------------------------------------------------------------------------------------------------------------------------------------------------------------------------------------------------------------------------------------------------------------------------------------------------------------------------------------------------------------------------------------------------------------------------------------------|---------------------------------------------|---------------------------|
| <u>Site Number:</u> 20 | | |
| <u>County:</u> Cook | <u>Township:</u> 36N | <u>Range:</u> 12E |
| <u>Section:</u> 29 | <u>Lat/Long:</u> 41°35'12.3" / 87°52'33" | <u>Quadrangle:</u> Mokena |
| <u>Property Owner:</u> Panduit Corporation, c/o Marty Cullen, Manager, Plant Engineering & Maintenance | | |
| <u>Address:</u> 17301 S Ridgeland Ave, Tinley Park, Illinois 604477-3091 | | |
| <u>Telephone:</u> 708/ 532-1800, ext. 1279 | | |
| <u>Permission Date:</u> May 1, 2008 | | |
| <u>Installation Date:</u> May 1, 2008 | | |
| <u>Gage Mfrs. No.:</u> 5280 | <u>Gage ID No.:</u> 5061 | |
| <p><u>Placement:</u> On 5-1-08, moved gage to Panduit Corporation property (10600 167th, Orland Park), about 600 feet to the north-northwest of old location. Site is along fence line of the western border of property. Was about 30 feet east of welding shop on rural property. Shop was east building of home/shop complex. Four dachshunds outside. Was located about 0.25 miles southeast on South 104th Avenue (9-26-89 through 3-16-90).</p> | | |

| SITE DESCRIPTION | | |
|--------------------------------------------------------------------------------------------------------------|-----------------------------------------------|---------------------------|
| <u>Site Number:</u> 21 | | |
| <u>County:</u> Cook | <u>Township:</u> 36N | <u>Range:</u> 13E |
| <u>Section:</u> 28 | <u>Lat/Long:</u> 41°35'12.5" / 87°44'54.7" | <u>Quadrangle:</u> Harvey |
| <u>Property Owner:</u> Private Residence | | |
| <u>Address:</u> 16710 Lockwood Road, Tinley Park, Illinois 60477 | | |
| <u>Telephone:</u> 708/ 560-0213 | | |
| <u>Permission Date:</u> September 16, 1989 | | |
| <u>Installation Date:</u> September 28, 1989 | | |
| <u>Gage Mfrs. No.:</u> 4692 | <u>Gage ID No.:</u> 5037 | |
| <u>Placement:</u> North end of backyard west of (behind) garage. Enter Lockwood Road south off 167th Street. | | |

| SITE DESCRIPTION | | |
|-----------------------------------------------------------------------------------------------------------------------------------------------------------------------------------------------------------------------------------------------------------------------------------------------------------------------------------------------------------------------|-----------------------------------------------|---------------------------|
| <u>Site Number:</u> 22 | | |
| <u>County:</u> Cook | <u>Township:</u> 36N | <u>Range:</u> 14E |
| <u>Section:</u> 21 | <u>Lat/Long:</u> 41°35'08.4" / 87°38'00.9" | <u>Quadrangle:</u> Harvey |
| <u>Property Owner:</u> U.S. Army Reserve Training Center, Attn: LTC Robert Goulke | | |
| <u>Address:</u> 400 East 167th Street, Harvey, Illinois 60426 | | |
| <u>Telephone:</u> 708/ 339-0001 | | |
| <u>Permission Date:</u> September 12, 1989 | | |
| <u>Installation Date:</u> September 26, 1989 | | |
| <u>Gage Mfrs. No.:</u> 5286 | <u>Gage ID No.:</u> 5035 | |
| <u>Placement:</u> Between parking lot and reserve building, just north of fenced-in reserve storage lot, about 150 feet south of 167th Street. Was located about 100 feet northwest on Army property, just west of parking lot before a building was constructed on property just to the west (9-26-89 through 11-02-90). Enter 167th Street east off Halsted Avenue. | | |

| SITE DESCRIPTION | | |
|---------------------------------------------------------------------------------------------------------------------------------------------------------------------------------------------------------------------------------------------------------------------------------------------------------------------------------------------------------------------------------|-----------------------------------------------|---------------------------------|
| <u>Site Number:</u> 23 | | |
| <u>County:</u> Cook | <u>Township:</u> 36N | <u>Range:</u> 15E |
| <u>Section:</u> 29 | <u>Lat/Long:</u> 41°35'16.0" / 87°32'50.1" | <u>Quadrangle:</u> Calumet City |
| <u>Property Owner:</u> Lansing Police Department, Attn: Commander Charles Maricich | | |
| <u>Address:</u> 2710 170 th Street, Lansing, Illinois 60438-1110 | | |
| <u>Telephone:</u> 708/ 895-7128 | | |
| <u>Permission Date:</u> April 30, 1998 | | |
| <u>Installation Date:</u> April 30, 1998 | | |
| <u>Gage Mfrs. No.:</u> 4723 | <u>Gage ID No.:</u> 5043 | |
| <u>Placement:</u> Moved about 0.5 miles west to a well-exposed location on the property of the Lansing Police Department on 4-30-98. Was east of garage/shed, between two trees (5-96 to 4-98). Was about 150 feet north, 6 feet from east fence in northeast corner of storage yard of Public Works complex, about 75 feet east of the same recycling building (9-89 to 5-96). | | |

| SITE DESCRIPTION | | |
|-----------------------------------------------------------------------------------------------------------------------------------------------------------------------------------------------------------------------------------------------------------------------------------------------------------------------------------------------------------------------------------|-----------------------------------------------|---------------------------|
| <u>Site Number:</u> 24 | | |
| <u>County:</u> Cook | <u>Township:</u> 35N | <u>Range:</u> 13E |
| <u>Section:</u> 16 | <u>Lat/Long:</u> 41°31'04.4" / 87°43'58.5" | <u>Quadrangle:</u> Harvey |
| <u>Property Owner:</u> Village of Matteson, Attn: Frank W. Denman | | |
| <u>Address:</u> 3625 West 215th Street, Matteson, Illinois 60443 | | |
| <u>Telephone:</u> 708/ 748-1411 | | |
| <u>Permission Date:</u> September 12, 1989 | | |
| <u>Installation Date:</u> September 26, 1989 | | |
| <u>Gage Mfrs. No.:</u> 4687 | <u>Gage ID No.:</u> WMU81122 | |
| <u>Placement:</u> Site moved 30 feet to the west, about 50 feet away from two 20-foot trees, one to the southwest and one to the southeast, about 30 feet away from a newly dug trench and building site (5-7-99). 5 feet west of telephone terminal box, on grass, north of parking lot and northeast of Matteson Police Department on Cicero Avenue, 0.5 mile north of U.S. 30. | | |

| SITE DESCRIPTION | | |
|----------------------------------------------------------------------------------------------------------------------------------------------------------------------------------------------------------------------------------------------------------------------------------------------------------------------------------------------|------------------------------------------------|---------------------------------|
| <u>Site Number:</u> 25 | | |
| <u>County:</u> Cook | <u>Township:</u> 35N | <u>Range:</u> 14E |
| <u>Section:</u> 13 | <u>Lat/Long:</u> 41°31'14.3" / 87°34'28.95" | <u>Quadrangle:</u> Calumet City |
| <u>Property Owner:</u> Big John's Farm Stand, Attn: John DeBoer | | |
| <u>Address:</u> 1754 East Joe Orr Road, Chicago Heights, Illinois 60411 | | |
| <u>Telephone:</u> 708/ 758-2711 | | |
| <u>Permission Date:</u> September 12, 1989 | | |
| <u>Installation Date:</u> September 26, 1989 | | |
| <u>Gage Mfrs. No.:</u> 4661 | <u>Gage ID No.:</u> WMU80955 | |
| <u>Placement:</u> Originally northeast of farm stand parking lot, northwest of house and northeast of farm stand. Small ditch between parking lot and gage, with large trees near house. On 20 May moved west 330 feet to more open, less trafficked area. Just east of Interstate 394 and Stony Island Avenue, and west of Torrence Avenue. | | |

APPENDIX II: INSTRUCTIONS FOR RAINGAGE TECHNICIANS

1. Supplies required for proper servicing of the instruments in the Cook County raingage network:

- A spare Campbell CR200 data logger
- A spare modem
- A spare antenna
- A spare null modem cable
- Spare 12-volt agm rechargeable batteries
- Spare data logger
- A roll of paper towels or similar absorbent material
- A ball-point pen or pencil
- Grass clippers and/or sickle
- Spare ant traps
- A clipboard
- A spare 12-quart bucket
- A set of weights for calibration
- A laptop computer and an a/c adapter

2. Make sure time is in the Central Standard Time zone:

Data logger times are coordinated with the computer collecting the data. The times are checked at midnight and are allowed a 1-second deviation.

3. Order of servicing upon arrival at a site:

1) Cut the grass around the raingage if necessary or applicable. Do this to the specifications of the landowner or below the level of the raingage door, whichever is shorter.

2) Remove the collector assembly (top cap) from the top of the gage by rotating the collector assembly clockwise to disengage the tongue-and-groove assembly, set it down, and then carefully lift the bucket off the weighing platform (if there is water in it). Weigh the bucket and collection, empty the bucket, clean with a paper towel and weigh the empty bucket for a tare. The grams of the collection divided by 823.7 yields the collection present in inches. During wintertime operations when a charge of antifreeze is in the bucket, leave the antifreeze until the data logger passes the 10-inch mark. At that point, pour the bucket contents into a sealed container and dispose properly. **DO NOT POUR SOLUTION ONTO THE GROUND!** If wintertime conditions prevail, reposition the dry bucket on the platform and reinstall the collector assembly by setting it on top of the raingage case and turning counterclockwise until the tongue-and-groove assembly meshes. Then recharge the empty bucket with one liter of antifreeze and

evaporation suppressant. At any time of the year, once the collector is repositioned, check the gage to make sure the collector orifice top edge is level.

3) Wipe the inside base of the gage to keep it relatively clean. Make sure you have removed all supplies and tools from the site before moving on to the next site. Note any serious problems encountered during servicing. Situations worthy of immediate attention include unauthorized movement of the raingage, vandalism, and theft. Make minor repairs (e.g., debris in the collection bucket, replace batteries with charged ones, etc.). Schedule major repairs as soon as possible.

4. Change in site status:

If you become aware that there has been or will be a change of status of one of the sites in the network, or one of the landowners requests movement of the raingage, alert the project director and contact the landowner to work out a new arrangement. It is important to try to keep the sites as permanent as possible during the course of this project.

5. Public relations:

As a representative of the state of Illinois, it is imperative that your contacts with the landowners and others are as cordial as possible and that you respect their property. They are providing an important service by agreeing to have the instrumentation on their property, so please keep their good will. Refer any questions they have that you are unable to answer concerning the project and your job to the project director. Remind them of the toll-free number, (866) 292-7305. Provide information on web access of real-time data (<http://www.isws.illinois.edu/atmos/ccprecipnet/>).

APPENDIX III: DOCUMENTATION OF RAINGAGE MAINTENANCE

This appendix documents the maintenance work carried out by Champaign-based Illinois State Water Survey staff at each network site from Water Year 1990 through Water Year 2013. Any unusual gage activity performed by non-Water Survey staff also is included. The technician normally re-levels the gages and trims vegetation around the gages when required, and replaces batteries if necessary, but those tasks are not listed. Calibration checks and gage cleaning activities conducted at various times throughout the water year are not listed here unless some other servicing was required at a particular site. Organized chronologically by site number, this documentation is accurate through September 30, 2013.

SITE #1: NORTHBROOK - MISSION BROOK SANITARY DISTRICT

- 10-95: Replaced gage at same location.
- 04-97: Moved gage about 10 feet to the northwest of the pumping station due to bulldozer activity in the property immediately adjacent to previous location.
- 05-08-97: Moved gage about 20 feet to the northwest of the pumping station.
- 09-10-98: Replaced chart drive.
- 06-26-99: After two instances of vandalism, replaced and moved gage about 20 feet to the north so that it is more visible at night. Added lock to gage.
- 02-01-01: Replaced old gage with rebuilt gage with data logger.
- 03-02-01: Replaced potentiometer.
- 08-01-02: Installed redesigned data logger.
- 11-04-04: Replaced gage housing after vandalism. Replaced chart drive. Installed co-located gage and data logger to south of Gage 1.
- 01-01-05: Co-located gage became primary gage. Removed original primary gage.
- 04-06-05: Reinstalled original (02-01-01) primary gage and data logger.
- 04-04-09: Replaced outer shell of the gage.
- 10-02-09: Replaced chart drive.
- 01-17-10: Installed co-located refurbished gage with Campbell data logger, modem, antenna, 12-volt battery, and wrap-around solar panel. New welded T-base installed.
- 05-20-10: Removed older gage, as both gages reported nearly equal precipitation.
- 05-20-10: Took pictures.
- 07-11-10: Took pictures.
- 09-30-10: Waxed gage inlet.
- 10-21-10: Soldered potentiometer connections. Installed secondary co-located gage with data fed to the primary gage data logger.

10-29/30-10: Took pictures. Installed 2 new T-bases.

06-13-11: Recalibrated gages.

09-01-11: Grounded logger and modem to base of gage.

03-19-12: Replaced co-located gage.

07-08-12: Added ground rod.

SITE #2: WINNETKA

09-10-97: Moved gage about 20 feet to the east of its previous location.

09-10-98: Replaced chart drive.

02-01-01: Replaced old gage with rebuilt gage with data logger.

08-10-01: Replaced chart drive.

06-06-02: Installed redesigned data logger.

08-01-02: Installed another redesigned data logger.

08-01-06: Replaced data logger.

01-02-07: Replaced vandalized gage.

07-02-07: Replaced data logger.

08-02-07: Replaced data logger that had a bad battery connection.

11-02-09: Replaced chart drive.

09-30-10: Replaced old gage with refurbished gage with Campbell data logger, modem, antenna, 12-volt battery, and wrap-around solar panel. New welded T-base installed. Waxed gage inlet and took pictures.

10-21-10: Installed external half wave dipole antenna.

10-29-10: Replaced data logger, battery, and malfunctioning modem.

11-9-10: Installed 10-watt rigid solar panel on south side of chain-link fence.

02-13-11: Snow from plow removed from around and over gage.

- 09-01-11: Grounded logger and modem to base of gage.
- 06-08-12: Moved gage 0.25 miles to the west.
- 07-08-12: Added ground rod, installed Wilson antenna with PolyPhaser surge protector.
- 08-25-13: Removed weeds in front of solar panel.

SITE #3: DES PLAINES

- 09-10-98: Replaced chart drive.
- 11-12-98: Replaced chart drive.
- 02-01-01: Replaced old gage with rebuilt gage with data logger.
- 09-18-02: Installed redesigned data logger.
- 05-02-06: Replaced data logger.
- 05-02-07: Replaced data logger that had a bad battery connection.
- 12-02-08: Replaced chart drive.
- 01-01-10: Replaced data logger.
- 09-30-10: Replaced old gage with refurbished gage with Campbell data logger, modem, antenna, 12-volt battery, and wrap-around solar panel. New welded T-base installed. Waxed gage inlet and took pictures.
- 10-21-10: Installed Wilson antenna.
- 10-03-11: Grounded logger and modem to base of gage.
- 12-11-11: Rigid 10-watt solar panel installed.
- 07-08-12: Installed Wilson antenna with Polyphaser surge protector.
- 08-19-12: Added ground rod.

SITE #4: VILLAGE OF SKOKIE

- 12-92: Moved gage 50 feet due east of the original location.
- 10-21-93: Replaced gage at same location after previous one accidentally destroyed by Village personnel two weeks earlier.
- 02-15-94: Replaced gage again. Previous one vandalized.
- 04-20-94: Movement in 03-94 by Village personnel necessitated a recalibration. Replaced chart drive and one support stake.
- 05-29-94: Replaced chart drive.
- 10-95: Replaced gage at same location.
- 09-10-98: Replaced chart drive.
- 02-01-01: Replaced old gage with rebuilt gage with data logger.
- 11-02-01: Removed trash from gage.
- 05-02-02: Removed trash from gage.
- 07-18-02: Installed redesigned data logger.
- 07-02-03: Replaced data logger.
- 06-06-05: Replaced data logger.
- 01-07-06: Replaced top cap.
- 09-06-06: Replaced chart drive. Removed trash from top cap.
- 11-01-06: Removed trash from gage.
- 12-02-06: Replaced bucket in gage.
- 01-01-07: Replaced data logger that had failed due to excessive corrosion, probably a result of the bucket leak.
- 02-01-07: Replaced data logger that had a bad battery connection.
- 06-01-07: Removed trash from gage funnel.
- 05-03-10: Dead robin found in gage and removed.

- 09-26-10: Replaced old gage with refurbished gage with Campbell data logger, modem, antenna, 12-volt battery, and wrap-around solar panel. New welded T-base installed.
- 09-26-10: Took pictures and waxed gage inlet.
- 10-21-10: Installed Wilson antenna.
- 03-30-11: Bucket stolen.
- 04-06-11: Bucket replaced.
- 06-13-11: Moved gage about 300 feet to the northeast to the east side of the backyard of a private residence. A 6-foot wooden privacy fence is 3 feet to its east, a two-story house about 40 feet to its west, and a 50-foot tree is located about 50 feet to its south.
- 06-30-11: Installed 10-watt solar panel.
- 09-01-11: Grounded logger and modem to base of gage.
- 10-17-11: Solar panel relocated from the gage to a nearby fence.
- 07-08-12: Installed Wilson antenna with PolyPhaser surge protector.
- 08-19-12: Wilson antenna replaced with an omni antenna.
- 12-02-12: Moved site 500 feet to the Northeast to a neighboring backyard, 3 feet west of a 6-foot fence. Solar panel was placed on the fence.

SITE #5: FRANKLIN PARK

- 10-21-93: Replaced bucket during a calibration visit.
- 11-12-98: Replaced chart drive.
- 02-01-01: Replaced old gage with rebuilt gage with data logger.
- 11-01-01: Replaced chart drive.
- 08-20-02: Installed redesigned data logger.
- 02-05-03: Replaced data logger.
- 08-19-04: Replaced gage and data logger.

11-04-04: Replaced chart drive.

07-07-05: Replaced data logger.

11-15-07: Replaced old gage with rebuilt gage.

11-02-09: Replaced chart drive.

09-30-10: Replaced old gage with refurbished gage with Campbell data logger, modem, antenna, 12-volt battery, and wrap-around solar panel. New welded T-base installed. Waxed gage inlet and took pictures.

10-21-10: Installed Wilson antenna.

10-03-11: Grounded logger and modem to base of gage.

07-08-12: Replaced Wilson antenna with Wilson antenna modified with a PolyPhaser surge protector.

08-19-12: Added ground rod, replaced modem.

SITE #6: Precision Dialogue Direct

07-12-93: Moved gage about 60 feet to the west-northwest to a backyard.

11-12-98: Replaced chart drive.

09-10-99: Replaced chart drive.

02-01-01: Replaced old gage with rebuilt gage with data logger.

08-01-02: Installed redesigned data logger.

04-01-04: Replaced data logger.

05-06-04: Replaced data logger.

02-02-05: Replaced data logger. When the replaced data logger was cleaned, an old spider web was found inside, causing intermittent noise problems.

09-26-10: Replaced old gage with refurbished gage with Campbell data logger, modem, antenna, 12-volt battery, and wrap-around solar panel. New welded T-base installed. Moved gage for better solar exposure.

- 09-26-10: Took pictures and waxed gage inlet.
- 10-21-10: Installed Wilson antenna.
- 06-13-11: Replaced T-base and replaced solar panel with 10-watt rigid panel.
- 07-11: Backyard tent installed covering gage.
- 10-03-11: Site moved about 2 miles to northwest to the Chicago Paper and Tube Company. Grounded logger and modem to base of gage. Replaced data logger and changed antenna from Wilson to dipole.
- 08-12-12: Bucket removed from gage.
- 08-30-12: John Dudlak reinstalled bucket.
- 04-10-13: John Dudlak reinstalled bucket and cap.
- 08-15-13: Modem, data logger and battery stolen.
- 09-25-13: Gage installed in small yard of Precision Dialogue Direct, 6 feet north of an east-west 6-foot fence and 10 feet south of a 35-foot building. The gage was grounded and calibrated.

SITE #7: BROADWAY UNITED METHODIST CHURCH

- 10-04-91: Moved to current location from Belmont Harbor boat landing (10-01-89 through 12-27-89); on the roof of the Lincoln Park Gun Club (12-27-89 through 06-28-91), and just north of Diversey Harbor in a playground (06-28-91 through 10-04-91).
- 04-20-94: Replaced chart drive.
- 5-17/19-96: Rotated gage base at the existing location to ensure a solid foundation.
- 11-12-98: Replaced chart drive.
- 02-01-01: Replaced old gage with rebuilt gage with data logger.
- 04-04-01: Removed considerable amount of gravel from the gage.
- 07-18-02: Installed redesigned data logger.
- 02-02-06: Replaced chart drive.

- 06-01-07: Removed debris (maple seeds, bird droppings) from gage funnel.
- 09-26-10: Replaced old gage with refurbished gage with Campbell data logger, modem, antenna, 12-volt battery, and wrap-around solar panel. New welded T-base installed.
- 09-26-10: Took pictures and waxed gage inlet.
- 10-21-10: Installed Wilson antenna.
- 11-09-10: Moved gage 6 feet east to the east side of iron fence for better sun exposure.
- 06-30-11: Installed 10-watt solar panel.
- 10-17-11: Grounded logger and modem to base of gage.
- 07-08-12: Added ground rod, installed Wilson antenna with PolyPhaser surge protector.
- 09-23-12: Moved solar panel to the fence for better solar exposure.
- 07-2013: Battery replaced by resident.
- 08-25-13: Gage found with door open, solar panel disconnected, and modem wires connected to solar panel terminals. Wired properly, installed updated program into data logger with a command for the modem to turn on between 13:58 and 14:30 CST for maintenance purposes. Replaced data logger.

SITE #8: WESTCHESTER - FOREST PRESERVE

- 06-02-95: Replaced chart drive.
- 09-11-97: Replaced gage at same location due to vandalism damage.
- 10-30-97: Replaced gage at same location due to vandalism damage (sword passed through cylinder).
- 12-11-97: Moved gage to more secure location, about 300 feet west-northwest of its previous location. It is just south of the end point of the Forest Preserve entrance road on west side of the Forest Preserve property, with the garages of two private homes about 30 feet to the southeast and northeast.

11-12-98: Replaced chart drive.

02-01-01: Replaced old gage with rebuilt gage with data logger.

08-20-02: Installed redesigned data logger.

10-07-02: Because of vandalism, replaced and moved gage about 100 feet south-southwest of old location. New location is more open and more visible from nearby houses and further from Forest Preserve path.

11-21-02: Replaced data logger.

02-05-03: Replaced data logger.

03-04-04: Replaced data logger.

06-04-04: Removed ants from gage.

04-08-05: Used ant bait.

09-18-05: Replaced batteries in data logger.

03-03-07: Replaced ant traps.

04-17-08: Replaced old gage with rebuilt gage.

01-17-10: Installed co-located refurbished gage with Campbell data logger, modem, antenna, 12-volt battery, and wrap-around solar panel.

02-07-10: Installed omni antenna.

03-02-10: Installed Wilson antenna.

05-20-10: Installed different co-located refurbished gage with Campbell data logger, modem, antenna, 12-volt battery, and wrap-around solar panel. New welded T-base installed. Moved gage and Wilson antenna 3 feet west to a sunnier location.

05-20-10: Took pictures.

07-11-10: Removed old gage. Took pictures.

09-30-10: Waxed gage inlet.

05-09-11: Replaced solar panel with 10-watt rigid panel.

- 10-02-11: Grounded logger and modem to base of gage.
- 03-19-12: Replaced refurbished gage.
- 07-02-12: Added ground rod, replaced modem, replaced the Wilson antenna with a dipole antenna.
- 07-15-12: Replaced dipole antenna with Wilson antenna modified with a PolyPhaser surge protector.

SITE #9: CICERO

- 10-28-93: Replaced chart drive during a calibration visit.
- 04-20-94: Replaced chart drive, repaired outer case.
- 06-24-94: Replaced outer case.
- 09-11-97: Replaced gage at same location.
- 04-09-98: After three instances of vandalism, replaced and relocated gage to the Cicero Water Station about 1.3 miles north of the old location. The gage is in the center of a 1-acre field, with a 150-foot tower 150 feet to the south, a 75-foot tree 100 feet to the north, a 20-foot building 100 feet to the east, and a 20-foot building 200 feet to the west.
- 04-30-98: Replaced chart drive.
- 02-01-01: Replaced old gage with rebuilt gage with data logger.
- 07-01-01: Moved gage to a protected area east of the service area, about 5 feet from a building, due to the construction of a new water tower.
- 06-07-02: Moved gage about 0.5 miles to Cicero Water Station on Roosevelt Drive. It is in a more open area, in the center of a 50- by 100-foot grassy lot, 50 feet west of a 20-foot water tank.
- 07-01-02: Installed redesigned data logger.
- 09-05: Gage, data logger, and T-base stolen.
- 09-18-05: Installed gage at new site in Berwyn about 2 miles west of old location. Gage is in backyard of a residence, approximately 10 feet east of a 1.5-story house, and about 30 feet west of a one-story garage.

- 01-07-06: Replaced chart drive.
 - 04-06-06: Replaced linear potentiometer.
 - 04-02-08: Replaced data logger.
 - 08-11-08: Gage moved to a new site at the Columbus Park Golf Course in Oak Park. Gage is about 1.5 miles northeast of previous location, and about 2 miles north of its long-time location in Cicero. It is about 10 feet south of the course one-story utility shed on the east border of the driving range.
 - 04-04-09: Replaced chart drive.
 - 08-08-10: Installed co-located refurbished gage with Campbell data logger, modem, antenna, 9-volt battery, and wrap-around solar panel. New welded T-base installed.
 - 08-08-10: Took pictures.
 - 09-30-10: Waxed gage inlet.
 - 10-21-10: Soldered potentiometer connections.
 - 11-10: Older co-located gage stolen. Top cap of new gage stolen.
 - 03-14-11: Replaced stolen refurbished gage. Moved gage 1 mile southeast to a previous location at Cicero Water Station on south Laramie. It is located 10 feet west of a 6-foot chain-link fence, 20 feet south of a single story building, and 130 feet southeast of a 100-foot tall water tower.
 - 06-30-11: Replaced gage.
 - 10-17-11: Grounded logger and modem to base of gage.
- SITE #10: WEST 26TH STREET**
- 02-05-99: Replaced chart drive.
 - 02-01-01: Replaced old gage with rebuilt gage with data logger.
 - 06-06-02: Replaced chart drive.
 - 07-18-02: Installed redesigned data logger.

- 04-02-03: Moved gage away from encroaching spruce tree, positioned about 5 feet east of 40-foot spruce, 5 feet north of one-story garage, and 15 feet west of two-story building.
- 03-02-07: Installed ant trap.
- 03-04-07: Replaced data logger that had a bad battery connection.
- 04-17-08: Replaced gage with rebuilt gage.
- 05-03-10: Found gage had been tampered with mid-April. Moved gage 3 feet to the west.
- 08-08-10: Replaced old gage with refurbished gage with Campbell data logger, modem, antenna, 12-volt battery, and wrap-around solar panel.
- 08-08-10: Took pictures.
- 09-01-10: Replaced battery with a recharged 12-volt battery.
- 09-30-10: Waxed gage inlet.
- 11-0-10: Installed Wilson antenna.
- 10-29-10: Installed a 15-watt rigid solar panel.
- 11-09-10: Replaced solar panel with a rigid 10-watt panel.
- 05-09-11: Replaced entire gage, data logger, and malfunctioning modem.
- 10-17-11: Grounded logger and modem to base of gage.
- 07-08-12: Installed Wilson antenna with PolyPhaser surge protector.

SITE #11: LA GRANGE

- 02-05-99: Replaced chart drive.
- 02-01-01: Installed rebuilt gage with data logger, while keeping the old gage for comparison purposes.
- 04-18-01: Moved both gages to new location along north edge of Edgewood Valley Country Club. Gages at highest point of golf course, about 60 feet from fence line separating the club from the 294 Tollway.

05-23-02: Installed redesigned data logger.

06-06-02: Tightened terminal strip pigtail connectors joining the potentiometer and data logger.

06-04-03: Removed ants and ant nest from gage.

04-02-04: Moved gage 10 feet to the east to a grassier area. Removed ants from gage.

06-04-04: Removed ants from gage.

04-08-05: Used ant bait.

03-03-07: Replaced ant traps.

06-01-07: Replaced ant traps. Removed debris (maple seeds, bird droppings) from gage funnel.

05-01-08: Replaced data logger.

02-01-10: Replaced chart drive.

05-03-10: Dead robin found in gage and removed.

05-20-10: Installed co-located refurbished gage with Campbell data logger, modem, antenna, 12-volt battery, and wrap-around solar panel. New welded T-base installed.

05-20-10: Took pictures.

07-11-10: Removed old gage. Took pictures.

09-30-10: Waxed gage inlet.

06-13-11: Replaced malfunctioning modem.

09-01-11: Grounded logger and modem to base of gage.

04-29-12: Replaced refurbished gage.

07-15-12: Added ground rod.

SITE #12: NEAR BEDFORD PARK - HALLSTAR

- 11-24-92: Moved gage west 0.9 miles, north of an office building.
- 05-17-93: Moved gage about 400–500 feet to the southwest along a service drive in a mowed grass area.
- 09-11-97: Replaced gage after damaged by a truck. Its new location is about 10 feet to the southwest of its previous location, up a small incline and closer to a 6-foot chain-link fence. It is approximately 35 feet east of a two-story building.
- 02-05-99: Replaced chart drive.
- 09-10-99: Replaced drum cylinder.
- 02-01-01: Replaced old gage with rebuilt gage with data logger.
- 07-01-02: Installed redesigned data logger.
- 02-05-03: Replaced data logger.
- 07-02-03: Replaced data logger.
- 03-01-06: Replaced data logger.
- 04-04-09: Replaced old gage with rebuilt gage with data logger.
- 08-08-10: Replaced old gage with refurbished gage with Campbell data logger, modem, antenna, 12-volt battery, and wrap-around solar panel. New welded T-base installed.
- 08-08-10: Took pictures.
- 09-30-10: Waxed gage inlet.
- 10-29/30-10: Installed Wilson antenna.
- 10-17-11: Grounded logger and modem to base of gage.
- 07-08-12: Added ground rod.
- 12-02-12: Replaced the flex solar panel with a rigid panel.
- 05-05-13: Replaced the gage, modem, data logger, and battery.

SITE #13: GREUNE COAL COMPANY

- 03-15-95: Moved gage from Eggleston Street to a sheltered coal yard of the Greune Coal Company on Onion Street, about four blocks due west of the old position, and replaced the chart drive.
- 12-06-95: Replaced T-base.
- 5-17/19-96: Replaced T-base.
- 02-22-99: Replaced chart drive.
- 05-03-99: Found gage moved about 10 feet to the southwest, to a “well-protected” position, about 7 feet from a 10-foot wall and 30 feet from a 25-foot tall elevated-train retaining wall.
- 02-01-01: Replaced old gage with rebuilt gage with data logger.
- 07-01-02: Installed redesigned data logger.
- 11-04-03: Replaced chart drive.
- 06-04-04: Replaced data logger.
- 09-15-10: Replaced old gage with refurbished gage with Campbell data logger, modem, antenna, 12-volt battery, and wrap-around solar panel.
- 09-30-10: Waxed gage inlet.
- 10-21-10: Installed external half wave dipole antenna.
- 03-02-11: Replaced gage. Found gage had been moved within site and bucket moved off center.
- 09-01-11: Grounded logger and modem to base of gage.
- 09-19-11: Moved gage 50 feet east, from ground and wooden base to 6 foot wall with a saddle base.
- 07-02-12: Replaced Wilson antenna with a dipole antenna.

SITE #14: SOUTH WATER PURIFICATION PLANT

- 03-19-95: Replaced chart drive.

- 12-06-95: Replaced T-base.
- 06-13-96: Replaced gage at same location after being hit by a riding lawn mower on June 10.
- 10-09-96: Installed snow shield.
- 04-30-98: Replaced chart drive.
- 02-15-01: Installed rebuilt gage with data logger, while keeping the old gage for comparison purposes.
- 10-03-01: Replaced chart drive. Installed Alter shield on rebuilt gage after removing old gage.
- 06-06-02: Installed redesigned data logger.
- 09-15-10: Replaced old gage with refurbished gage with Campbell data logger, modem, antenna, 12-volt battery, and wrap-around solar panel. New welded T-base installed.
- 09-30-10: Waxed gage inlet.
- 10-29/30-10: Installed Wilson antenna.
- 09-01-11: Grounded logger and modem to base of gage.
- 09-19-11: Replaced refurbished gage.
- 07-02-12: Added ground rod, replaced modem, replaced the Wilson antenna with a Wilson antenna modified with a PolyPhaser surge protector.

SITE #15: LEMONT - SAINT MARY'S SEMINARY

- 11-22-94: Moved gage about 1.5 miles east from MWRDGC complex in Lemont to the grounds of the Franciscan Fathers on Main Street in Lemont.
- 02-05-99: Replaced chart drive.
- 01-13-01: Installed rebuilt gage with data logger, while keeping the old gage for comparison purposes.
- 11-15-01: Replaced chart drive.

06-06-02: Tightened terminal strip connectors.
06-24-02: Installed redesigned data logger.
08-01-03: Replaced data logger.
09-03-03: Replaced data logger.
12-15-03: Tightened terminal strip connectors.
04-08-05: Used ant bait.
11-02-07: Remounted gage after being hit by mower on October 26.
01-01-10: Replaced chart drive.
01-17-10: Installed co-located refurbished gage with Campbell data logger, modem, antenna, 12-volt battery, and wrap-around solar panel. New welded T-base installed.
07-11-10: Took pictures.
09-30-10: Waxed gage inlet.
09-01-11: Grounded logger and modem to base of gage.
09-19-11: Replaced refurbished gage.
12-11-11: Rigid 10-watt solar panel installed.
12-18-11: Removed co-located gage.
07-15-12: Added ground rod, installed Wilson antenna with PolyPhaser surge protector.

SITE #16: PALOS PARK

02-05-99: Replaced chart drive.
02-01-01: Replaced old gage with rebuilt gage with data logger.
11-01-01: Replaced terminal strip connectors.
06-24-02: Installed redesigned data logger.

06-17-03: Replaced data logger.
08-01-03: Replaced data logger.
06-17-04: Replaced data logger.
09-06-06: Replaced chart drive.
11-15-07: Replaced data logger.
08-08-10: Replaced old gage with refurbished gage with Campbell data logger, modem, antenna, 12-volt battery, and wrap-around solar panel.
08-08-10: Took pictures.
09-30-10: Waxed gage inlet.
09-01-11: Grounded logger and modem to base of gage.

SITE #17: ALSIP - FIRE DEPARTMENT STATION #2

11-04-93: Replaced chart drive during a calibration visit.
06-24-94: Replaced chart drive.
08-09-94: Moved gage about 150 yards south-southeast from Sardee Industries to Alsip Fire Department Station #2.
11-21-96: Replaced gage at same location.
02-05-99: Replaced chart drive.
07-21-00: Replaced chart drive.
01-24-01: Installed rebuilt gage with data logger, while keeping the old gage for comparison purposes.
11-01-01: Replaced terminal strip connectors.
06-06-02: Installed redesigned data logger.
05-26-04: Replaced gage.
06-16-06: Replaced gage and linear potentiometer.

- 07-11-10: Installed co-located refurbished gage with Campbell data logger, modem, antenna, 12-volt battery, and wrap-around solar panel. New welded T-base installed.
- 08-08-10: Installed omni antenna.
- 09-30-10: Waxed gage inlet.
- 10-21-10: Soldered potentiometer connections.
- 01-03-11: Replaced top cap on original gage.
- 09-01-11: Grounded logger and modem to base of gage.
- 12-18-11: Removed co-located gage.
- 07-08-12: Added ground rod.

SITE #18: WEST 119TH STREET - AxleTech International

- 11-04-93: Replaced chart drive during a calibration visit.
- 08-09-94: Moved gage about 150 feet north of previous location in work yard.
- 02-22-99: Replaced chart drive.
- 02-01-01: Replaced old gage with rebuilt gage with data logger.
- 11-15-01: Replaced chart drive.
- 05-23-02: Installed redesigned data logger.
- 06-06-02: Tightened terminal strip connectors.
- 03-05-03: Moved site from Ingersol to Heat Treat.
- 04-02-03: Moved gage to more secure position on same property after vandalism. Gage is positioned about 600 feet north-northeast of location at Ingersol in center of a fenced area, south of employee parking. Replaced chart drive and data logger.
- 05-01-03: Removed wasp nest from gage.
- 09-03-03: Replaced data logger.

- 06-04-04: Replaced data logger.
- 06-04-04: Removed ants from gage.
- 03-03-07: Replaced ant traps.
- 09-15-10: Installed co-located refurbished gage with Campbell data logger, modem, antenna, 12-volt battery, and wrap-around solar panel. New welded T-base installed.
- 09-26-10: Took pictures.
- 09-30-10: Waxed gage inlet.
- 10-21-10: Installed Wilson antenna.
- 09-01-11: Removed co-located gage.
- 09-01-11: Grounded logger and modem to base of gage.
- 07-02-12: Added ground rod and replaced Wilson antenna with an omni antenna.

SITE #19: AVENUE O - GALLO EQUIPMENT

- 11-24-92: Moved gage 50 feet west to grassy area just north of a shop building and just south of an entrance drive.
- 5-17/19-96: Rotated gage base at the existing location to ensure a solid foundation.
- 02-22-99: Replaced chart drive.
- 01-13-01: Installed rebuilt gage with data logger, while keeping the old gage for comparison purposes.
- 10-03-01: Replaced chart drive.
- 06-24-02: Installed redesigned data logger. Tightened terminal strip connectors.
- 02-14-08: Replaced data logger.
- 04-17-08: Replaced old gage with rebuilt gage, and replaced data logger.
- 09-15-10: Installed co-located refurbished gage with Campbell data logger, modem, antenna, 12-volt battery, and wrap-around solar panel. New welded T-base installed. Co-located gage site is 36 feet to the north of old location.

- 09-30-10: Waxed gage inlet.
- 10-21-10: Installed Wilson antenna.
- 07-14-11: Moved gages 0.45 miles north to the parking lot of Gallo's Equipment. . A 6-foot tall chain-link fence is 3 feet to its south, a 30-foot tall commercial building 45 feet to its southeast.
- 09-01-11: Grounded logger and modem to base of gage.
- 09-19-11: Removed co-located gage.
- 07-02-12: Added ground rod and replaced Wilson antenna with a dipole antenna.
- 10-31-12: Replaced modem.
- 12-02-12: Replaced the flex solar panel with a rigid panel.

SITE #20: ORLAND PARK

- 03-16-90: Moved gage about 0.25 miles to the northwest to rural property about 30 feet east of a welding shop.
- 5-17/19-96: Rotated gage base at the existing location to ensure a solid foundation.
- 04-30-98: Replaced chart drive.
- 02-15-01: Installed rebuilt gage with data logger, while keeping the old gage for comparison purposes.
- 03-06-02: Installed redesigned data logger.
- 07-02-03: Moved gage about 30 feet to south of previous location; it is located about 30 feet east of a welding shop, 60 feet east-southeast of a 30-foot pine, and 50 feet west of a 40-foot tree line.
- 05-26-04: Replaced gage.
- 09-06-06: Restored top cap to proper position after being vandalized.
- 01-02-07: Replaced data logger that had a bad battery connection.
- 02-02-07: Replaced data logger that had a bad battery connection.

- 03-03-07: Replaced ant traps.
- 06-01-07: Removed debris (maple seeds, bird droppings) from gage funnel.
- 11-02-07: Remounted gage after being hit by mower on July 10.
- 04-03-08: Leveled the gage after it had been vandalized on March 29.
- 05-01-08: Moved gage to new location at Panduit Corporation, about 600 feet to the NNW of the old location. Site is along the fence line of the western border of the property.
- 12-02-08: Replaced chart drive.
- 05-20-10: Installed co-located refurbished gage with Campbell data logger, modem, antenna, 12-volt battery, and wrap-around solar panel.
- 07-11-10: Removed old gage.
- 09-30-10: Waxed gage inlet.
- 10-21-10: Soldered potentiometer connections.
- 09-19-11: Grounded logger and modem to base of gage.
- 07-08-12: Added ground rod.
- 05-05-13: Replaced modem.

SITE #21: TINLEY PARK

- 02-16-95: Replaced chart drive.
- 05-22-95: Replaced chart drive again.
- 02-01-01: Replaced old gage with rebuilt gage with data logger.
- 08-10-01: Replaced chart drive.
- 05-02-02: Installed redesigned data logger.
- 11-04-03: Replaced chart drive.
- 05-07-04: Replaced data logger.

06-04-04: Removed ants from gage.

12-02-08: Replaced chart drive.

01-01-10: Replaced data logger.

03-03-10: Replaced data logger.

07-11-10: Installed refurbished gage with Campbell data logger, modem, antenna, 12-volt battery, and wrap-around solar panel. New welded T-base installed.

07-11-10: Took pictures.

08-08-10: Installed omni antenna.

09-30-10: Waxed gage inlet.

10-21-10: Installed Wilson antenna.

06-13-11: Replaced T-base and replaced solar panel with 10-watt rigid panel. Moved gage 4 feet to the north for better solar exposure.

09-19-11: Grounded logger and modem to base of gage. Cleared weeds obstructing solar panel.

04-29-12: Replaced modem.

07-02-12: Added ground rod and replaced Wilson antenna with a dipole antenna.

07-15-12: Replaced dipole antenna with Wilson antenna modified with a PolyPhaser surge protector.

08-19-12: Patio blocks were laid around gage to keep weed growth away from solar panel.

05-15-13: Reinstalled modem repaired at ISWS.

SITE #22: HARVEY

11-02-90: Moved gage about 100 feet to the southeast, between a parking lot and an Army reserve building, just north of a reserve storage area.

02-22-99: Replaced chart drive.

- 01-13-01: Installed rebuilt gage with data logger, while keeping the old gage for comparison purposes.
- 04-18-02: Installed redesigned data logger.
- 06-06-02: Tightened terminal strip connectors.
- 06-18-02: Replaced data logger.
- 08-06-03: Tightened terminal strip connectors and replaced data logger.
- 04-02-04: Replaced data logger.
- 05-05-05: Replaced data logger.
- 09-03-08: Replaced the evaporation shield (top cap), which had been stolen.
- 05-03-10: Repositioned gage as it was found tilted at 60° angle and amounts low for last week of month.
- 07-11-10: Installed refurbished gage with Campbell data logger, modem, antenna, 12-volt battery, and wrap-around solar panel. New welded T-base installed.
- 07-11-10: Took pictures.
- 09-15-10: Installed omni antenna.
- 09-30-10: Waxed gage inlet.
- 09-01-11: Grounded logger and modem to base of gage.

SITE #23: LANSING - POLICE DEPARTMENT

- 04-24-96: Moved gage 150 feet south of the previous location at the request of the property manager.
- 5-15/17-96: Moved site slightly, so it is evenly spaced between two trees (one about 15 feet to the south and one about 15 feet to the north). It is close to the site where it was moved on 04-24-96, still about 150 feet south of the previous long-standing location.
- 04-30-98: Replaced and relocated the gage approximately 0.5 miles to the west, to a well-exposed location on the property of the Lansing Police Department.

A one-story building is 100 feet to the east, and 170th St. is about 1000 feet to the south.

- 01-24-01: Installed rebuilt gage with data logger, while keeping the old gage for comparison purposes.
- 04-18-02: Installed redesigned data logger.
- 08-01-03: Removed ant nest from gage.
- 09-06-06: Replaced ant traps. Unclogged top cap.
- 03-03-07: Replaced ant traps.
- 02-02-09: Replaced chart drive.
- 04-04-09: Replaced chart drive.
- 01-17-10: Installed co-located refurbished gage with Campbell data logger, modem, antenna, 12-volt battery, and wrap-around solar panel.
- 08-08-10: Took pictures.
- 09-30-10: Waxed gage inlet.
- 09-01-11: Grounded logger and modem to base of gage.
- 09-19-11: Replaced refurbished gage.
- 01-27-12: Replaced refurbished gage.
- 07-02-12: Added ground rod.

SITE #24: MATTESON - POLICE DEPARTMENT

- 06-11-98: Drum cylinder discovered stolen and subsequently replaced.
- 05-07-99: Moved site about 30 feet to the west, about 50 feet away from two 20-foot trees, one to the southwest and one to the southeast, about 30 feet away from a newly dug trench and building site.
- 01-13-01: Installed rebuilt gage with data logger, while keeping the old gage for comparison purposes.
- 11-01-01: Replaced terminal strip connectors.

04-04-02: Installed redesigned data logger.

05-02-02: Removed ants from gage.

07-02-03: Removed ants from gage.

06-04-04: Removed ants from gage.

09-01-05: Replaced data logger.

01-02-07: Replaced pigtail connector in potentiometer.

05-04-07: Replaced data logger which had bad battery connection.

01-17-10: Installed co-located refurbished gage with Campbell data logger, modem, antenna, 12-volt battery, and wrap-around solar panel.

05-20-10: Took pictures.

07-11-10: Replaced co-located refurbished gage with Campbell data logger, modem, antenna, 12-volt battery, and wrap-around solar panel. New welded T-base installed.

07-11-10: Took pictures.

09-30-10: Waxed gage inlet.

09-01-11: Grounded logger and modem to base of gage.

12-18-11: Removed co-located gage.

07-02-12: Added ground rod.

06-03-13: Removed bird from gage.

SITE #25: CHICAGO HEIGHTS - BIG JOHN'S FARM STAND

11-04-93: Replaced chart drive during a calibration visit.

02-15-94: Replaced chart drive.

01-13-01: Installed rebuilt gage with data logger, while keeping the old gage for comparison purposes.

- 03-06-02: Installed redesigned data logger.
- 06-17-04: Replaced data logger.
- 08-04-05: Installed co-located gage and data logger.
- 07-19-07: Removed two co-located gages and replaced with a single refurbished gage. The two gages were installed in backyard of the ISWS for further monitoring.
- 05-03-10: Gage found moved several feet from its previous location.
- 05-20-10: Moved gage west 330 feet to more open, less trafficked area. Installed co-located refurbished gage with Campbell data logger, modem, antenna, 12-volt battery, and wrap-around solar panel. New welded T-base installed.
- 08-08-10: Took pictures.
- 09-30-10: Waxed gage inlet.
- 07-14-11: Replaced gage and data logger.
- 09-01-11: Removed co-located gage.
- 09-01-11: Grounded logger and modem to base of gage.
- 04-29-12: Leveled T-base.
- 07-02-12: Added ground rod and replaced Wilson antenna with a dipole antenna.
- 05-05-13: Site had flooded., with evidence of 4 inches of water inside the case. Water had completely covered the modem and battery, and partially covered the data logger.
- 05-15-13: Reinstalled cleaned and calibrated gage, with new modem. Tee-base replaced with one 10-inches taller.

APPENDIX IV: DOCUMENTATION OF HIGH STORM TOTALS

This appendix documents individual gage storm totals (within the 125 storms) that exceeded annual event criteria (one-year recurrence interval) during Water Year 2013. Within the storm period, if several precipitation periods were present at an individual gage and were separated by six hours or more, only the heaviest precipitation period was considered. Leading and trailing hourly precipitation amounts of less than 0.04 inches were ignored. Storm durations of one hour to three days were evaluated. The precipitation amounts for 1-year to 100-year recurrence intervals and the aforementioned storm durations for northeastern Illinois are given below in Table IV-1 (Huff and Angel, 1989).

Table IV-1. Precipitation thresholds for 1-year to 100-year heavy precipitation storm events of varying duration.

| <i>Storm Duration</i> | <i>Precipitation Amounts (inches)</i> | | | | | | |
|-----------------------|---------------------------------------|-------------|-------------|--------------|--------------|--------------|---------------|
| | <i>1-yr</i> | <i>2-yr</i> | <i>5-yr</i> | <i>10-yr</i> | <i>25-yr</i> | <i>50-yr</i> | <i>100-yr</i> |
| 1 hour | 1.18 | 1.43 | 1.79 | 2.10 | 2.59 | 3.04 | 3.56 |
| 2 hours | 1.48 | 1.79 | 2.24 | 2.64 | 3.25 | 3.82 | 4.47 |
| 3 hours | 1.60 | 1.94 | 2.43 | 2.86 | 3.53 | 4.14 | 4.85 |
| 6 hours | 1.88 | 2.28 | 2.85 | 3.35 | 4.13 | 4.85 | 5.68 |
| 12 hours | 2.18 | 2.64 | 3.31 | 3.89 | 4.79 | 5.62 | 6.59 |
| 18 hours | 2.30 | 2.79 | 3.50 | 4.11 | 5.06 | 5.95 | 6.97 |
| 24 hours | 2.51 | 3.04 | 3.80 | 4.47 | 5.51 | 6.46 | 7.58 |
| 48 hours | 2.70 | 3.30 | 4.09 | 4.81 | 5.88 | 6.84 | 8.16 |
| 72 hours | 2.93 | 3.55 | 4.44 | 5.18 | 6.32 | 7.41 | 8.78 |

The values listed in Table IV-2 exceed the numbers above for the given storm duration. If necessary, an "e" indicates a partial or full estimate for a particular site and storm, based on a spatial interpolation of the hourly precipitation values of neighboring gages. The last column indicates whether a particular gage within the given storm exceeded a precipitation value greater than an annual event criterion (2-year to 100-year recurrence intervals considered).

The isohyetal patterns of the largest four storms that have occurred in Cook County during the past six years are presented in Figure IV-1a-d. The network average for the 9/12-13/2008 storm was 6.99 inches with 11 gages in the 50-year and 3 gages in the 100-year recurrence interval; for the 7/23-24/2010 storm, the network average was 4.52 inches with 5 gages in the 50-year and 3 gages in the 100-year recurrence interval; for the 7/22-23/2011 event the network average was 2.87 inches with 1 gage in the 50-year and 3 gages in the 100-year recurrence interval; and finally for the 4/17-18/2013 storm, the network average was 4.47 inches with 1 gage in the 50-year recurrence interval.

Table IV-2. Storm event totals for Water Year 2013 heavy precipitation events.

| <i>Storm #</i> | <i>Date</i> | <i>Site #</i> | <i>Duration (hour)</i> | <i>Amount (inch)</i> | <i>Storm Recurrence Frequency</i> |
|----------------|------------------|---------------|------------------------|----------------------|-------------------------------------------|
| 60 | 4 / 17 - 18 / 13 | 1 | 23 | 4.04 | 5-year |
| | | 2 | 23 | 4.62 | 10-year |
| | | 3 | 25 | 5.22 | 10-year |
| | | 4 | 25 | 5.82 | 25-year |
| | | 5 | 23 | 6.80 | 50-year |
| | | 6 | 27 | 6.36 | 25-year |
| | | 7 | 20 | 4.38 | 10-year |
| | | 8 | 24 | 5.39 | 10-year |
| | | 9 | 20 | 4.70 | 10-year |
| | | 10 | 24 | 3.56 | 2-year |
| | | 11 | 25 | 4.41 | 5-year |
| | | 12 | 23 | 3.97 | 5-year |
| | | 13 | 26 | 3.84 | 5-year |
| | | 14 | 25 | 5.06 | 10-year |
| | | 15 | 23 | 3.69 | 2-year |
| | | 16 | 23 | 3.98 | 5-year |
| | | 17 | 25 | 3.74 | 2-year |
| | | 18 | 25 | 4.90 | 10-year |
| | | 19 | 25 | 5.29 | 10-year |
| | | 20 | 24 | 4.14 | 5-year |
| | | 21 | 25 | 4.78 | 10-year |
| | | 22 | 25 | 4.98 | 10-year |
| | | 23 | 24 | 5.12 | 10-year |
| | | 24 | 25 | 4.00 | 5-year |
| | | 25 | 24 | 3.98 | 5-year |
| 73 | 5 / 28 / 13 | 10 | 2 | 1.55 | |
| | | 12 | 2 | 2.33 | 5-year |
| | | 13 | 2 | 1.77 | |
| | | 15 | 2 | 1.61 | |
| 75 | 5 / 30 / 13 | 25 | 4 | 2.10 | 2-year |
| 91 | 6 / 26 / 13 | 1 | 6 | 4.64 | 25-year |
| | | 2 | 6 | 2.98 | 5-year |
| | | 3 | 6 | 3.40 | 10-year |
| | | 4 | 5 | 3.20 | 10-year |
| | | 6 | 7 | 1.95 | |
| | | 7 | 4 | 2.73 | 5-year |

| <i>Storm #</i> | <i>Date</i> | <i>Site #</i> | <i>Duration (hour)</i> | <i>Amount (inch)</i> | <i>Storm Recurrence Frequency</i> |
|----------------|------------------|---------------|------------------------|----------------------|-------------------------------------------|
| 109 | 8 / 2 / 13 | 18 | 4 | 2.26 | 2-year |
| 118 | 8 / 30 - 31 / 13 | 8 | 3 | 1.68 | |
| | | 13 | 1 | 1.36 | |
| 124 | 9 / 18 / 13 | 5 | 3 | 1.74 | |
| | | 7 | 4 | 2.16 | 2-year |
| | | 10 | 4 | 5.06 | 50-year |
| | | 13 | 3 | 2.15 | 2-year |
| | | 14 | 3 | 3.28 | 10-year |
| | | 19 | 4 | 2.66 | 5-year |

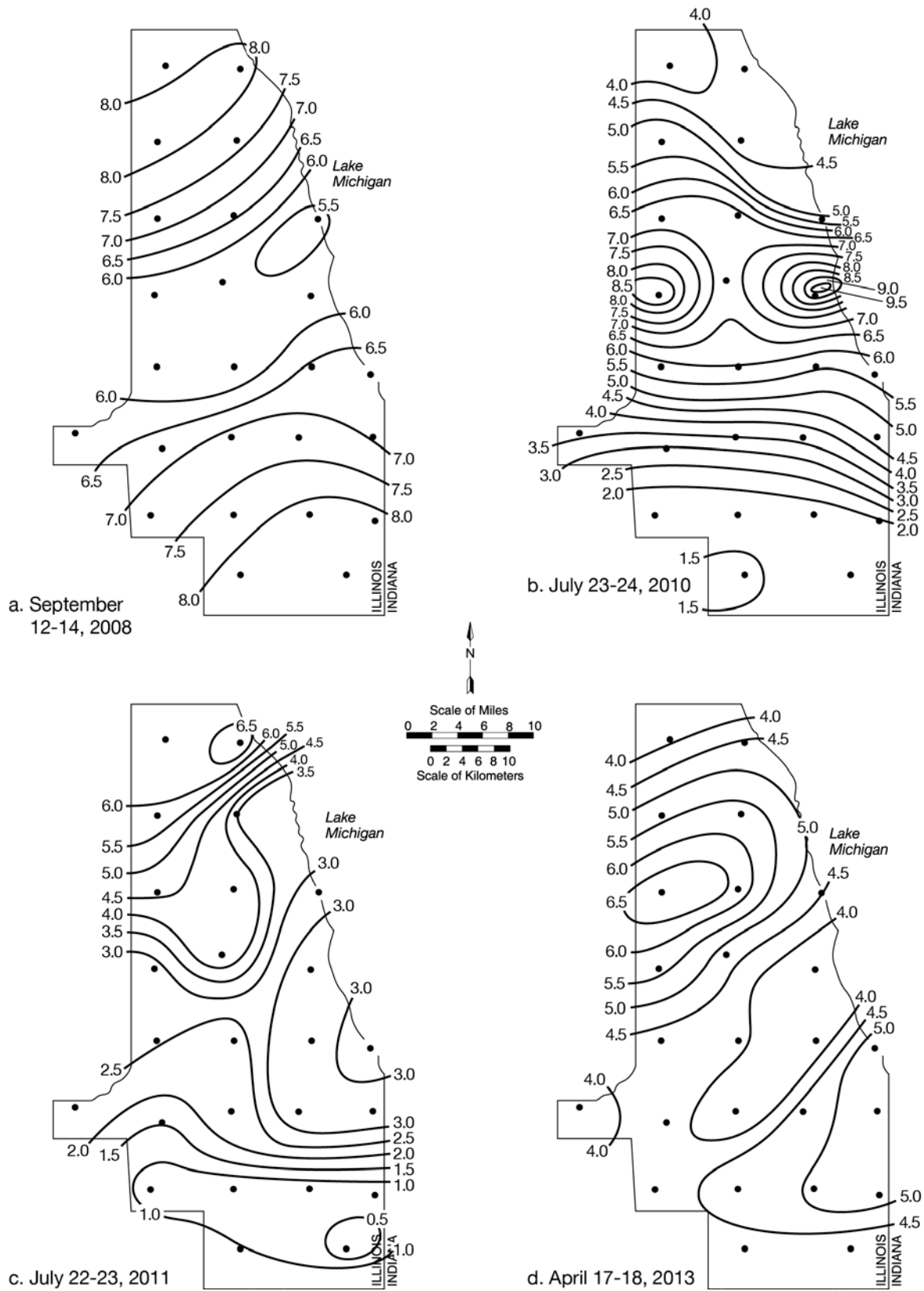

Figure IV-1. The four most intense storm events during Water Years 2008-2013.

