

COOPERATIVE GROUNDWATER REPORT 9
ILLINOIS STATE WATER SURVEY
ILLINOIS STATE GEOLOGICAL SURVEY
Champaign, Illinois 61820

**RETENTION OF
ZINC, CADMIUM, COPPER, AND LEAD
BY GEOLOGIC MATERIALS**

James P. Gibb and Keros Cartwright

Prepared in cooperation with
Municipal Environmental Research Laboratory
U.S. Environmental Protection Agency

STATE OF ILLINOIS
DEPARTMENT OF ENERGY AND NATURAL RESOURCES

1982

**RETENTION OF
ZINC, CADMIUM, COPPER, AND LEAD
BY GEOLOGIC MATERIALS**

James P. Gibb and Keros Cartwright

STATE WATER SURVEY

STATE GEOLOGICAL SURVEY

In cooperation with

**Municipal Environmental Research Laboratory
U.S. Environmental Protection Agency
Cincinnati, OH 45268**

CHAMPAIGN, ILLINOIS

1982

STATE OF ILLINOIS
HON. JAMES R. THOMPSON, Governor

DEPARTMENT OF ENERGY AND NATURAL RESOURCES
MICHAEL B. WITTE, B.A., Director

BOARD OF NATURAL RESOURCES AND CONSERVATION

Michael B. Witte, B.A., Chairman

Walter E. Hanson, M.S., Engineering

Laurence L. Sloss, Ph.D., Geology

H. S. Gutowsky, Ph.D., Chemistry

Lorin I. Nevling, Ph.D., Forestry

Robert L. Metcalf, Ph.D., Biology

Daniel C. Drucker, Ph.D.
University of Illinois

John C. Guyon, Ph.D.
Southern Illinois University



STATE WATER SURVEY
Stanley A. Changnon, Jr., *Chief*

STATE GEOLOGICAL SURVEY
Robert E. Bergstrom, *Chief*

FOREWORD

This publication summarizes the results of research conducted by the Illinois State Water Survey and State Geological Survey. The research was funded in part (Contract No. R-803216) by the Solid and Hazardous Waste Research Division (SHWRD), Municipal Environmental Research Laboratory, U.S. Environmental Protection Agency, Cincinnati, Ohio. The project officer was Mike H. Roulier of SHWRD.

The report has been reviewed by the U.S. Environmental Protection Agency and released for publication as a combined report. Approval does not signify that the contents necessarily reflect the views and policies of the U.S. Environmental Protection Agency, nor does mention of trade names or commercial products constitute endorsement or recommendation for use by any of the respective agencies.

This report describes a study of the effectiveness of glaciated region soils in retaining toxic metals. It also contains an evaluation of several investigative and monitoring techniques for their effectiveness in detecting and quantitatively measuring the extent of groundwater contamination from surface waste disposal activities.

James P. Gibb
Head, Groundwater Section
Illinois State Water Survey

Keros Cartwright
Head, Hydrogeology and Geophysics
Illinois State Geological Survey

ABSTRACT

The vertical and horizontal migration patterns of zinc, cadmium, copper, and lead through the soil and shallow aquifer systems at two secondary zinc smelters were defined by use of soil coring and monitoring well techniques. The vertical migration of the same elements at a third zinc smelter also was defined. The migration of metals at the three smelters has been limited by attenuation processes to relatively shallow depths in the soil profile. Cation exchange and precipitation of insoluble metal compounds, resulting from pH changes in the infiltrating solution, were determined to be the principal mechanisms controlling the movement of the metals through the soil. Increased metal contents in the shallow groundwater systems have been confined to the immediate plant sites.

Soil coring was found to be an effective investigative tool but was not suitable by itself for routine monitoring of waste disposal activities. It should be used to gather preliminary information to aid in determining the proper horizontal and vertical locations for monitoring wells. The analyses of water samples collected in this project generally did not yield a stable, reproducible pattern of results. This indicates the need to develop techniques to obtain representative water samples. The failure of some well seals in a highly polluted environment also indicates the need for additional research into monitoring well construction.

CONTENTS

	Page
Figures	vi
Tables.	vii
Acknowledgments.	viii
1. Introduction	1
2. Principal field techniques.	2
Coring	2
Core sampling	3
Core analysis	3
Well construction and use	4
Pumping mechanism	6
Water sampling.	7
Water analysis.	8
3. Supplemental field techniques	8
Electrical earth resistivity methods.	9
Temperature surveys	10
Infrared photography.	11
4. Sites used in the study.	12
Regional geology.	12
Stratigraphy.	15
5. Case histories	16
Site A.	16
Geology.	16
Hydrology	23
Chemical data	32
Site B.	51
Geology.	51
Hydrology.	58
Chemical data	64
Site C.	69
Geology.	70
Hydrology	72
Chemical data	74
6. Conclusions	81
References	82
Appendix. Data from selected borings.	85

FIGURES

Number	Page
1 Typical well and pumping mechanism	5
2 Effects of pumping on zinc content of water samples	8
3 Glacial map of Illinois	13
4 Time relationships of glacial periods, unconsolidated sediments, and soil development in Illinois	14
5 Location map -- Site A	17
6 Stratigraphic cross section -- Site A	18
7 Electrical earth resistivity stations and results -- Site A	22
8 Pumping test data for well 2S -- Site A	25
9 Water level hydrographs for shallow wells -- Site A	27
10 Piezometric surface maps for a) March 1976, and b) November 1975, for shallow wells at Site A	29
11 Water level hydrographs for deep wells -- Site A	30
12 Estimated piezometric surface map for deep wells -- Site A	31
13 Soil temperature stations and results -- Site A	33
14 West-east profiles of zinc concentrations in soil -- Site A	34
15 North-south profiles of zinc concentrations in soil -- Site A	38
16 Profiles of cadmium concentrations in soil -- Site A	40
17 Profiles of copper concentrations in soil -- Site A	41
18 Profiles of lead concentrations in soil -- Site A	42
19 Profiles of zinc concentrations in stream bed soil -- Site A	43
20 Representative adsorption isotherms for zinc, copper, and cadmium at various pH values	45
21 Montmorillonite adsorption isotherms for cadmium, zinc, and copper	46
22 Zinc content of water from shallow wells -- Site A	49
23 Location map -- Site B	52
24 Generalized maps for a) drift thickness and b) bedrock surface -- Site B	53
25 West-east stratigraphic cross section -- Site B	54
26 North-south stratigraphic cross section -- Site B	54
27 Thickness of Enion Formation -- Site B	58
28 Water level hydrographs for shallow and deep wells -- Site B	59
29 Piezometric surface maps for a) March 1975, and b) October 1976, for shallow wells at Site B	61
30 Estimated piezometric surface map for deep wells -- Site B	62
31 Soil temperature stations and results -- Site B	63
32 West-east profiles of zinc concentrations in soil -- Site B	65
33 North-south profiles of zinc concentrations in soil -- Site B	66
34 Profile of zinc concentrations in stream bed soil -- Site B	67
35 Location map -- Site C	70
36 Stratigraphic cross section -- Site C	71
37 Pumping test data for wells TWI and 4D -- Site C	73
38 Water level hydrographs for all wells -- Site C	75
39 Piezometric surface maps for a) June 1976, and b) October 1976, for shallow wells at Site C	76
40 Soil temperature stations and results -- Site C	77

TABLES

Number		Page
1	Chemical properties of waste materials -- Site A	17
2	Textural and mineralogical data for stratigraphic units -- Site A	19
3	True resistivity values for six stations -- Site A	24
4	Range of water level fluctuations in shallow wells -- Site A . .	26
5	Range of water level fluctuations in deep wells -- Site A. . . .	31
6	Zinc concentrations in water samples from wells at Site A. . . .	48
7	Selected total mineral analyses data -- Site A	50
8	Textural and mineralogical data for stratigraphic units -- Site B.	55
9	Range of water level fluctuations in shallow wells -- Site B . .	60
10	Range of water level fluctuations in deep wells -- Site B. . . .	62
11	Zinc concentrations in water samples from wells at Site B. . . .	68
12	Total mineral analyses data for control holes -- Site B. . . .	69
13	Range of water level fluctuations in all wells -- Site C	77
14	Concentrations (mg/l) of trace elements in bottom sediments from backwater lake south of Site C.	79
15	Zinc concentrations in water samples from wells at Site C. . . .	80

ACKNOWLEDGMENTS

The authors wish to express their gratitude to the three industries that permitted studies to be conducted on their property. In accordance with the provisions set forth in this study, the names and locations of these industries are not specified. Coring and well installations at Sites A and B were done by Layne Western Co., Kirkwood, Missouri; special thanks go to Marion Scouby, who furnished the drilling crew and technical advice.

Susan S. Wickham and Dave Lindorf of the Illinois State Geological Survey provided geological support. Keith Stoffel and Donald McKay collected samples during drilling. H. Edward Scoggin operated the drilling rig at Site C. Robert Gilkeson conducted the resistivity and temperature surveys and wrote those portions of the report. Dr. W. Arthur White supervised textural analysis of samples, and Dr. Herbert D. Glass performed X-ray analyses of samples.

Personnel of the Environmental Research Analytical Laboratory at the University of Illinois conducted all metals analyses under the direction of Arnold Hartley. Paul Schroeter maintained the integrity of sample acquisition, preparation, and storage. Drs. Phillip Hopke and Mary Ulrich conducted X-ray fluorescence analyses. John Healy, Paul Amberg, Brad Hess, Clifford Colgan, and Dr. Donald Bath performed the atomic absorption measurements. Alan Matton, Mary Perez, Susan Gould, and Jean Mitchell did the electrochemical measurements and the determinations of soil pH and cation exchange capacity.

The project was conducted under the general supervision of John B. Stall, former Head of the Hydrology Section, Illinois State Water Survey. Richard J. Schicht reviewed the manuscript and gave guidance throughout the latter stages of the project. Steve Wirth and William Bogner tabulated the tables of data; John Brother, Jr., William Motherway, Jr., and June Gibb prepared the illustrations; T. A. Prickett conducted and analyzed the pumping test at Site C; Gail Taylor edited the final report; and Pamela Lovett and Lynn Weiss typed the final manuscript.

Special thanks are given to William H. Walker, who conceived and initiated the project. The patience and understanding of Mike Roulier, the project officer of the USEPA, helped make possible the transition of leadership and completion of the project.

SECTION 1

INTRODUCTION

Existing air and surface water pollution regulations have forced large volumes of chemical waste to the land for ultimate disposal. As a result, some aquifers may be in danger of serious water quality degradation if these disposal activities are not properly controlled and monitored.

As of 1981, 120 land disposal sites were under permit by the Illinois Environmental Protection Agency to receive special wastes. In addition, more than 2000 active or abandoned landfill sites and private industrial disposal sites have received large but unknown quantities of all types of wastes, including some toxic chemicals. Some of these are adjacent to or directly underlain by shallow aquifer systems vulnerable to contamination from surface sources.

The amount and area¹ extent of hazardous material migration from these disposal sites is not known. Some are monitored for possible contamination or pollution of contiguous aquifers, but only a few appear to be effectively instrumented. Traditionally, monitoring wells are installed and water samples are collected and analyzed periodically. However, these wells generally cannot monitor very large vertical segments of an aquifer, and the water samples are not always analyzed for the many different organic or inorganic chemical compounds that may originate from the disposal sites. In addition, little or no effort has been made to insure that the samples collected are representative of water contained in the aquifer.

The primary purpose of this study was to study in the field the effectiveness of glaciated region soils and associated shallow geologic deposits in retaining specific toxic chemicals. The study also was designed to investigate monitoring techniques for detecting and quantitatively evaluating the extent of groundwater contamination from surface waste disposal activities. Three industrial complexes -- known as Sites A, B, and C -- were selected for study. The field work for the study was accomplished during the period July 1974 through April 1977.

Special emphasis was placed on defining: a) the vertical and horizontal migration patterns of chemical contaminants through the soil and shallow aquifer system; and b) the residual chemical buildup in soils in the vicinity of pollution sources. In accomplishing these goals, an understanding was developed of the practical aspects of core drilling, soil sampling, piezometer installation, and water sample collection.

SECTION 2

PRINCIPAL FIELD TECHNIQUES

The collection of continuous vertical core samples for geologic study and chemical analyses, and the construction of piezometers or monitoring wells for water level measurements and water sampling were the principal field techniques used in this study.

Coring

Continuous vertical core sampling was conducted with conventional Shelby tube and split spoon sampling methods through hollow stem augers. Dry drilling techniques were used to minimize the chemical alteration of samples from drilling fluids or external water sources.

Coring was done with a truck-mounted Central Mining Equipment (CME) 55 rig and a CME 750 rig mounted on an all-terrain vehicle. The first core sample taken at any given location was obtained by pushing a 3-inch outside diameter No. 6 gauge, Shelby tube to a depth of 2-1/2 feet. After this tube and sample were withdrawn, a 2-3/4-inch outside diameter tube with a 1/8-inch thick wall was pushed inside the hole to obtain a sample from the 2-1/2- to 5-foot depth. The 5-foot sampled segment of the hole was then cleaned out and enlarged with a 7-inch-diameter hollow-stem auger.

Repeated sequential sampling through the hollow-stem augers continued in the same manner until dense materials made thin-wall-tube sampling impossible. At two sites examined in this report (Sites A and B) this usually occurred at a depth of about 15 feet. A thin section of sandy material generally was present just above this depth. Because water from this zone was suspected to be contaminated, a 7-inch-diameter casing was driven into the underlying dense till material to prevent downward migration of water from this unit and possible chemical alteration of deeper soil samples.

Core sampling of the till materials below the 7-inch casing was done with a 2-inch outside diameter split spoon sampler driven through a 6-inch-diameter hollow-stem auger. Where soft materials permitted, Shelby tube sampling was reemployed. The split spoon-drill rod assembly is driven ahead of the hollow-stem augers in P-foot increments with either a 140- or 350-pound hammer depending on the hardness of the material being sampled. In some of the softer materials penetrated, it was possible to drive 2 split spoons coupled together (total sample length 4 feet) before enlarging and deepening the hole with the augers and repeating the sampling procedures.

In some of the first core holes completed, some difficulty was experienced in getting full recovery from each sample probe. Through experimentation, it was determined that full recovery was greatly dependent on using clean Shelby tubes; reuse of tubes without thorough cleaning invariably resulted in poor recovery and could result in sample contamination. Also, in some very soft sections, it was occasionally necessary to crimp the

cutting edges of the Shelby tubes to get full recovery. A straight and constant vertical pull in withdrawing all samples from the hole was essential; any jarring of the sampling device during extraction usually resulted in loss of the sample.

The thin-wall tubes (No. 6 gauge) used were easily damaged during sampling, often by small pebbles. When this happened, the damaged end of the tube was removed with a pipe cutter, leaving a thicker wall for the cutting edge and allowing reuse of the tubes. Because of this problem, care must be exercised in selecting the sampling method in any future studies of this type.

Sites A and B were predominantly clay environments, and relatively little drilling and sampling difficulty was experienced. Site C was a river bottom sandy environment, and some difficulties were experienced with sand heaving up in the augers. Special care in slowly withdrawing the center drill pin and sampling devices helped to minimize this problem but did not stop it. In extreme cases, the split spoon was slowly washed down through the sand that had heaved up in the auger until the split spoon was at the proper depth to begin sampling. During this process, clear, clean water was circulated down through the drilling rods and split spoon and allowed to flow up inside the augers. Circulation continued for a short time after the proper depth was reached to insure that no sand from inside the augers was in the spoon. The rate of circulating water should be adequate to keep the split spoon clean of sand yet minimize the washing disturbance in front of the spoon. Most of the sand in the augers must also be washed out or the spoon can become locked in the augers after being driven.

If the sampling in a sandy environment is for geologic definition only, or if chemical analysis for the contaminants being investigated would not be affected by bentonite, drilling with mud and sampling through a thin mud cake at the bottom of the bore hole should be considered.

Core Sampling

Shelby tube and split spoon samples were extruded in the field, cut into 6-inch lengths, placed in properly labeled wide mouth glass jars, and subsequently delivered to the Illinois State Geological Survey and Environmental Research Analytical Laboratory (ERAL) for processing and analysis. One 6-inch length of the core from each 5-foot segment or each change in formation was taken by the drilling contractor for moisture content determination before being sent for geologic and chemical analysis.

Core Analysis

Core samples for heavy metals determinations were analyzed at ERAL with zinc as a target element. Previous experience in determining heavy metal contaminants in soil showed that digestion of a dried soil sample in 3M HCl at slightly elevated temperatures effectively released the metals without destroying the silicate lattice of the soil. The metals were determined primarily by atomic absorption spectroscopy.

For a number of soil samples, the multi-element capability of optical emission spectroscopy was used to determine cadmium, copper, lead, and zinc concentrations. For greater efficiency, instrumentation and methods also were developed for use of nondispersive X-ray emission spectroscopy to permit semi-automated multi-element analysis for a larger number of elements.

Tests using atomic absorption measurement of small spot samples indicated that the 6-inch-long samples were too heterogeneous to permit reproducible analysis of spot samples. Reproducible results for the 6-inch-long sample were attained by homogenizing the samples and subdividing them to sample weight levels of 1 gram for atomic absorption and 50 milligrams for optical emission spectroscopy. Pelletized samples of approximately 2 grams were prepared for X-ray emission spectroscopy.

Well Construction and Use

Analysis of water samples from observation wells has been the traditional method for monitoring groundwater contamination. To evaluate the effectiveness of this approach and the relative costs of using wells and using coring, a number of small-diameter (2-inch) observation wells were constructed. Because metal contaminants were expected, plastic casing, screen, and pumping equipment were used.

Observation wells at Sites A and B were constructed in the following manner. A 7-inch-diameter hole was constructed to the bedrock surface and a 2-inch-diameter PVC pipe (bottom 2 feet slotted with a hacksaw) was placed in the borehole. Gravel was placed from the bottom of the hole to a level about 1 foot above the slotted portion of the pipe. The remainder of the annulus was filled with bentonite slurry to land surface (see Figure 1). Shallow observation wells of similar construction were installed in overlying water-bearing sections approximately 3 feet away from the deep wells, usually at depths of about 15 to 30 feet below land surface.

At Site C, where heaving sand was encountered and the bore hole would collapse when the augers were removed, more difficulty was encountered in installing observation wells. In many instances the 2-inch-diameter pipe and casing were placed inside the hollow stem augers and held down while the augers were slowly pulled, allowing sand to collapse around the screen and casing. In other instances, a completed screen and casing assembly was washed down through the collapsed materials in the bore hole to the desired depth. For the deeper installations the first procedure usually proved more successful. The shallower wells were easily washed down.

Seventeen wells at Site B also were constructed by a multi-well technique (placement of several wells of different depths in one bore hole) to evaluate the relative merits of the two methods. In the multi-well method, a deep well (casing, screen, and gravel) was installed at the bottom of the core hole, and the annulus between the casing and bore hole was filled with bentonite from the top of the screen in the deep well to the bottom of the screen in an intermediate-depth well. The interval from the top of this middle well screen and gravel to the bottom of the shallow well screen and gravel also was backfilled with bentonite, and finally that

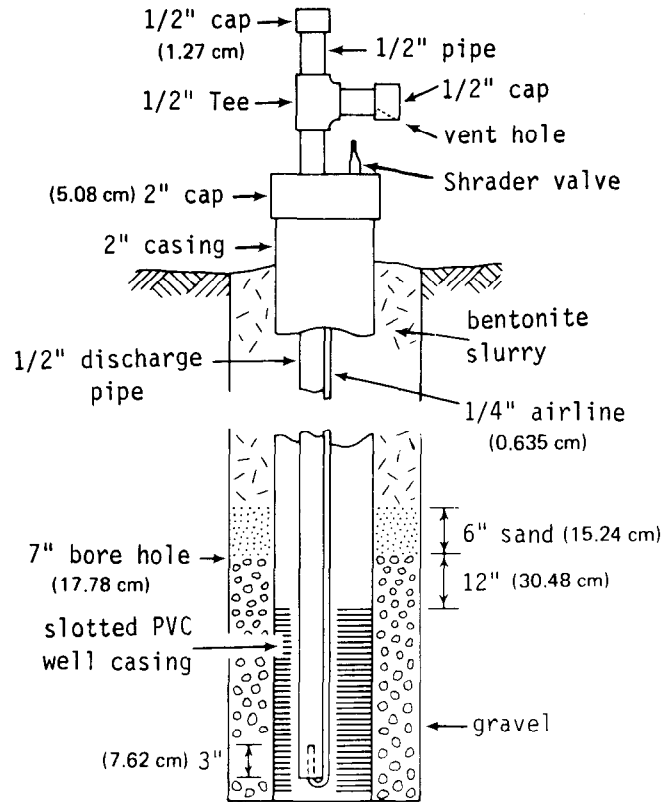

Figure 1. Typical well and pumping mechanism

part of the hole from the top of the shallow well screen and gravel to land surface was filled with bentonite slurry.

This method of well installation proved to be far more time consuming and costly than the method for installing single wells. In addition, subsequent well development efforts indicated that some of the multi-well installations were not effectively sealed between well screens. As a result, noticeable drawdowns occurred in the upper wells each time one of the deeper wells was pumped. If accurate placement of a liquid bentonite slurry or other suitable sealant between wells could be accomplished under normal field working conditions, it is likely that the multi-well concept would be as dependable as the individual well-cluster system. Multi-well installations are more difficult to construct than single completions; however, they also provide a means of testing well seals. The individual well-cluster system employing a liquid slurry bentonite mixture appeared to be the most practical method for our project.

The use of sodium bentonite to seal out highly mineralized waters such as those encountered at our study sites may have been part of the problem. The normal swelling-sealing capability of sodium bentonite may have been so seriously affected by such waters that well seal failures were almost inevitable, and some of our observation wells may have failed because of this factor. Effective seals cannot be achieved with bentonite in an environment that is already affected by contaminants such as at Sites A and B.

To determine more accurately the effectiveness of bentonite as a well sealant, an attempt was made to use strontium chloride as a tracer or indicator of well seal failure. Strontium chloride was added to the water used to make the bentonite slurries that were placed around several wells. In theory, when the bentonite seal began to break down in a particular well, strontium concentrations several orders of magnitude above natural levels would be released and detected in the water samples from that well. However, this did not occur during the entire study. In fact, higher strontium concentrations were often detected in water samples from wells where the bentonite seal had not been "spiked." It is possible that the sampling procedures used to collect water samples (discussed in the next section) flushed out any released strontium from the bentonite seal before the sample was taken. In any case, we were unable to determine by this technique if the bentonite seals had failed.

Pumping Mechanism

Observation wells were equipped with individual pumping devices to minimize possible contamination of samples from other wells. The pumping devices consisted of a 1/2-inch-diameter PVC discharge pipe that extended from above the 2-inch well casing to the bottom of the well. A tee fitted with short nipples and removable caps was placed at the top of this pipe (Figure 1). The cap on the vertical segment could be removed to allow for water level measurements within the 1/2-inch pipe. The cap on the horizontal segment (water discharge outlet) was vented to permit stabilization of the water level within this pipe.

A 1/4-inch plastic airline was also installed in each well. The airline was attached to a Shrader valve at the top of the well casing and extended the entire depth of the well. The lower end of the airline was bent up into the bottom of the 1/2-inch discharge pipe for a distance of about 3 inches.

Water was pumped from the wells by removing the cap from the horizontal portion of the 1/2-inch or 3/8-inch pipe and applying air to the system through the Shrader valve. Pumping from depths as great as 70 feet was possible with only a bicycle-type hand pump. A gasoline powered, 4-cylinder air compressor capable of delivering about 5 cubic feet per minute at pressures up to 60 pounds per square inch (psi) also was used. An activated charcoal filter was placed in the discharge airline from the compressor to insure that air from the compressor was not introducing airborne contaminants.

Since most of the wells in this study generally had a column of water less than 30 or 40 feet deep to be moved by the air lift mechanisms, it was found that operating the compressor at 20 to 25 pounds per square inch was most effective. Higher operating pressures caused the air bubbles to rise through the water column instead of pushing slugs of water in front of them as desired. In the very shallow wells, less than 20 feet deep, the bicycle-type hand pump actually worked more effectively.

Water Sampling

Water level measurements were made and water samples were collected from each well once a month. Water samples were collected in 6-ounce plastic containers and placed on ice until they were brought into the laboratory, where they were refrigerated. Each well was pumped for a period of time theoretically adequate to insure that all stored water in the well casing had been removed. The wells were allowed to recover, and a sample was then collected from water that had just entered the well. This procedure was followed in hopes that the water sample would be representative of the water flowing through the aquifer at the time of collection.

Near the end of the project a brief experiment was conducted on four wells at Site A to determine if the pumping scheme just described was necessary or adequate for collecting representative water samples. Wells were selected on the basis of early results of chemical analyses of water samples collected. Zinc concentrations in water from the four wells had ranged from 6.2 to 25.9 mg/l, 300 to 790 mg/l, 342 to 850 mg/l, and 12,700 to 21,580 mg/l, respectively. These values represent fluctuations in zinc content of 76, 62, 60, and 42 percent using the higher values as base concentrations.

To determine if these fluctuations were real or a function of the sampling procedure, the following experiment was conducted. Water level measurements were taken in each well and the volumes of water stored in the 2-inch-diameter casings and screens were calculated. Pumping was initiated and samples were collected just after pumping began and at increments of one-half the total stored water volume until a total of 5 volumes had been pumped.

Figure 2 illustrates the results of these tests for the four wells. Percentage decreases in zinc concentrations from the first sample to the last ranged from about 45 to 78 percent with the greatest decreases occurring in the wells with the lowest zinc concentrations. Reductions in zinc content at the 1 volume pumped stage (the procedure followed in our sampling program) ranged from about 18 to 46 percent. This suggests that all of the zinc determinations of water samples collected could be as much as 30 percent higher than the stabilized zinc content beyond the 5-volume pumped stage. If the sampling procedure employed varied by even as little as 50 percent, pumping only one-half or one and one-half the stored volume, it could account for as much as 15 to 20 percent of the fluctuations in the sample results.

Additional experiments of this type should be undertaken to design satisfactory sampling procedures for other chemicals. Further, these experiments should be done at the beginning of a project as opposed to near the end as in this case. The results of these brief tests were the impetus for later work conducted by Gibb et al. (1981). Results of that work indicate that sampling for metals should not be attempted with the type of air-lift mechanism employed in this project. The metals content of samples collected with this mechanism is likely to be lower than that of water in the formation being sampled.

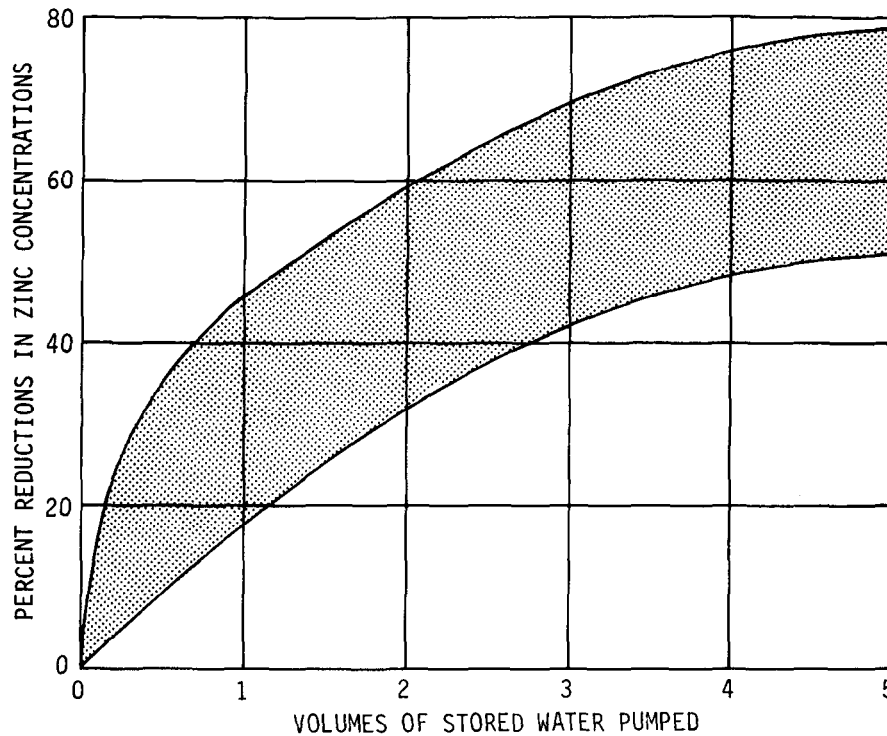

Figure 2. Effects of pumping on zinc content of water samples

Water Analysis

Water samples were analyzed at the Environmental Research Analytical Laboratory for heavy metals determinations, with zinc as the target element. Two electrochemical methods, anodic stripping voltametry and pulse polarography, proved to be the most effective for making zinc determinations and screening for the presence of other metals of interest. Total mineral analyses were conducted at the laboratories of the Illinois State Water Survey by standard procedures.

SECTION 3

SUPPLEMENTAL FIELD TECHNIQUES

Early in an investigation of groundwater contamination problems it is essential to have information on geologic conditions in the region. Definition of the groundwater flow system also is important. Because large areas and considerable depths may be involved, gathering this information through a systematic drilling program may be economically unfeasible.

Geologists and engineers are making increased use of geophysical methods to rapidly determine shallow geologic conditions. Two of these geophysical methods, the measurement of electrical earth resistivity and the measurement of soil temperature, are useful for economic, rapid investigation of geologic conditions related to groundwater contamination. These geophysical methods can provide information on the regional variation of the lithologic character of the shallow geologic materials. They also can provide information on the shallow groundwater flow system and possibly can define zones of degraded water quality within the flow system.

Electrical Earth Resistivity Methods

A comprehensive review of the theory and interpretation of electrical earth resistivity is presented by Van Nostrand and Cook (1966). The use of electrical earth resistivity methods in groundwater contamination studies is discussed in many papers. Cartwright and Sherman (1972) discuss resistivity methods as useful tools in locating suitable sanitary landfill sites and in monitoring the effect of a refuse disposal site on a shallow groundwater systems. Berk and Yare (1977) describe a case in which groundwater contamination problems were caused by disposal of industrial process water into an unlined lagoon in permeable sediments. They tell how electrical earth resistivity methods were used successfully to define zones of degraded water quality and to locate sites for monitoring wells.

A common approach for making electrical earth resistivity measurements is to use the Wenner configuration, where four electrodes are spaced equally along a straight line. Through systematic enlargement of the distance (a-spacing) between electrodes, the electrical field is expanded to include a greater volume of earth materials. The value of the apparent resistivity obtained at each a-spacing approximates the average of the true resistivity of all the materials within the impressed field. The apparent resistivity depth profile generated at a location by taking measurements at several a-spacings can be reduced analytically to determine the number of layers of geologic material present and the thickness and true resistivity of each layer.

The fundamental factors that govern resistance to the flow of electrical current through earth materials are: a) water saturation, b) mineral content of the water, and c) geologic factors.

The presence of water is important to the conductance of an electric current through earth materials. In general, saturated materials have a

higher conductivity (lower apparent resistivity) than similar unsaturated materials.

The mineral content of the water present in earth materials is a major controlling factor of the conductance of electrical current through the material. As the ionic content of the water increases, the apparent resistivity of the earth material decreases.

There are two geologic factors which affect apparent resistivity values. One of these, the "formation factor," relates to the porosity of the earth material as well as the shape of the pores and the manner in which they are interconnected. A second geologic factor which affects apparent resistivity is the presence of conductive solids such as clay minerals. An increase in the amount of clay minerals present in an earth material will lower the apparent resistivity of that material. Generally, fine-grained clayey sediments have lower apparent resistivities than clean, coarse sands and gravels.

An electrical earth resistivity survey was made at Site A to determine the applicability of this technique. The results of that work are described in the case history of Site A.

Temperature Surveys

The distribution of temperature within the lithosphere can be significantly affected by the movement of groundwater. Cartwright (1968) used soil temperatures to locate shallow aquifers and discussed (1974) the use of soil temperature to trace shallow groundwater flow systems. There is limited published information on the application of soil temperatures as a tool for investigation of groundwater contamination problems. Cartwright and McComas (1968) used soil temperature measurements in the vicinity of two sanitary landfills to map shallow groundwater flow systems and discharges of leachate.

In field investigations, soil temperature measurements are commonly made with a thermistor at the tip of an insulated probe. The probe can be inserted into the soil to any desired depth. Measurements are usually made at depths greater than 19.7 inches to eliminate diurnal temperature variations. Temperatures are read after the probe comes into equilibrium with the soil, roughly after about 5 minutes.

Factors which affect the temperature of the soils in the flow system include the velocity of groundwater movement, the vertical or lateral direction of groundwater movement, lithology of the geologic materials which affects their thermal properties, heating effects due to land cover, and geothermal heat added to the system.

Human activities can serve as sources of heat which affect local soil temperatures. Cartwright and Reed (1972) measured anomalous high soil temperatures in the vicinity of a village. Heat generated at industrial sites may have a significant effect on soil temperatures locally, with the distribution of this heat related to the shallow groundwater flow system in the vicinity of the site.

Soil temperature surveys were made at all sites to test the applicability of this method.

Infrared Photography

Infrared aerial photographs of Sites A and B were taken in the early part of October 1974 by the National Environmental Research Center - Las Vegas, U.S. Environmental Protection Agency. Another round of flights was made in June 1975. Examination of these photos provided very little information concerning the groundwater conditions or effects of groundwater pollution at these sites.

The photos were helpful however in detecting past effects of wind-blown pollutants and surface water movement of pollutants. Dr. William R. Edwards, Illinois State Natural History Survey, found the photos useful in conducting a preliminary study of the plant life at Site A. A brief description of his results is included in the case history of Site A.

SECTION 4

SITES USED IN THE STUDY

Three industrial complexes (Sites A, B, and C) were selected for a study of the effects of waste disposal on soils and shallow groundwater systems.

Two sites (A and B) located in moraine and ridged drift areas of south-central Illinois initially were selected for study on the basis of geology, the types and quantities of waste generated, and the manner of disposal. It was thought desirable to study areas where the unconsolidated materials are relatively thin (less than 50 to 75 feet) and underlain by Pennsylvanian age shales. Special emphasis was also given to sites where glacial materials were predominantly low-permeability clays, silts, and tills. Such sites theoretically would be desirable for disposal activities with little resulting groundwater contamination.

To determine the general applicability of the coring technique as a monitoring tool, a third site (C) located in a sandy alluvium environment in north-central Illinois (presumably undesirable for disposal activity) was chosen later. Sites A, B, and C are secondary zinc smelting plants that have generated large volumes of metals-rich waste material over many years of operations. Most of this waste has been in the form of cinders that have been piled on or spread over the plant properties as fill material.

The selection of sites to be studied ultimately is decided by industrial politics. Because of the necessity of releasing all data collected during a study, it is often difficult to convince the officers of an industry of the merits of a study. In most cases the company involved has very little to gain and the potential for great losses (bad publicity, regulatory action by state and federal government, or the discovery of unknown problems). In the planning of any proposed research, it is recommended that written permission be obtained from the appropriate industrial officers to insure that the desired sites can in fact be studied.

Regional Geology

The areas of study in this project all are underlain by varying thicknesses of unconsolidated materials of Pleistocene age over bedrock. During the Pleistocene, four major periods of glacial advance (Nebraskan, Kansan, Illinoian, and Wisconsinan) occurred in Illinois. These periods were separated by interglacial episodes of soil formation (Aftonian, Yarmouthian, and Sangamonian Stages). Figure 3 illustrates the regional distribution of interglacial episodes in Illinois. Figure 4 indicates the time relationships of the glacial periods, unconsolidated sediments (rock stratigraphy), and soil development in Illinois.

The Nebraskan glacial advance represented the first episode of Pleistocene glaciation in Illinois and covered a relatively small portion of western Illinois, resulting in a scarcity of Nebraskan-age glacial

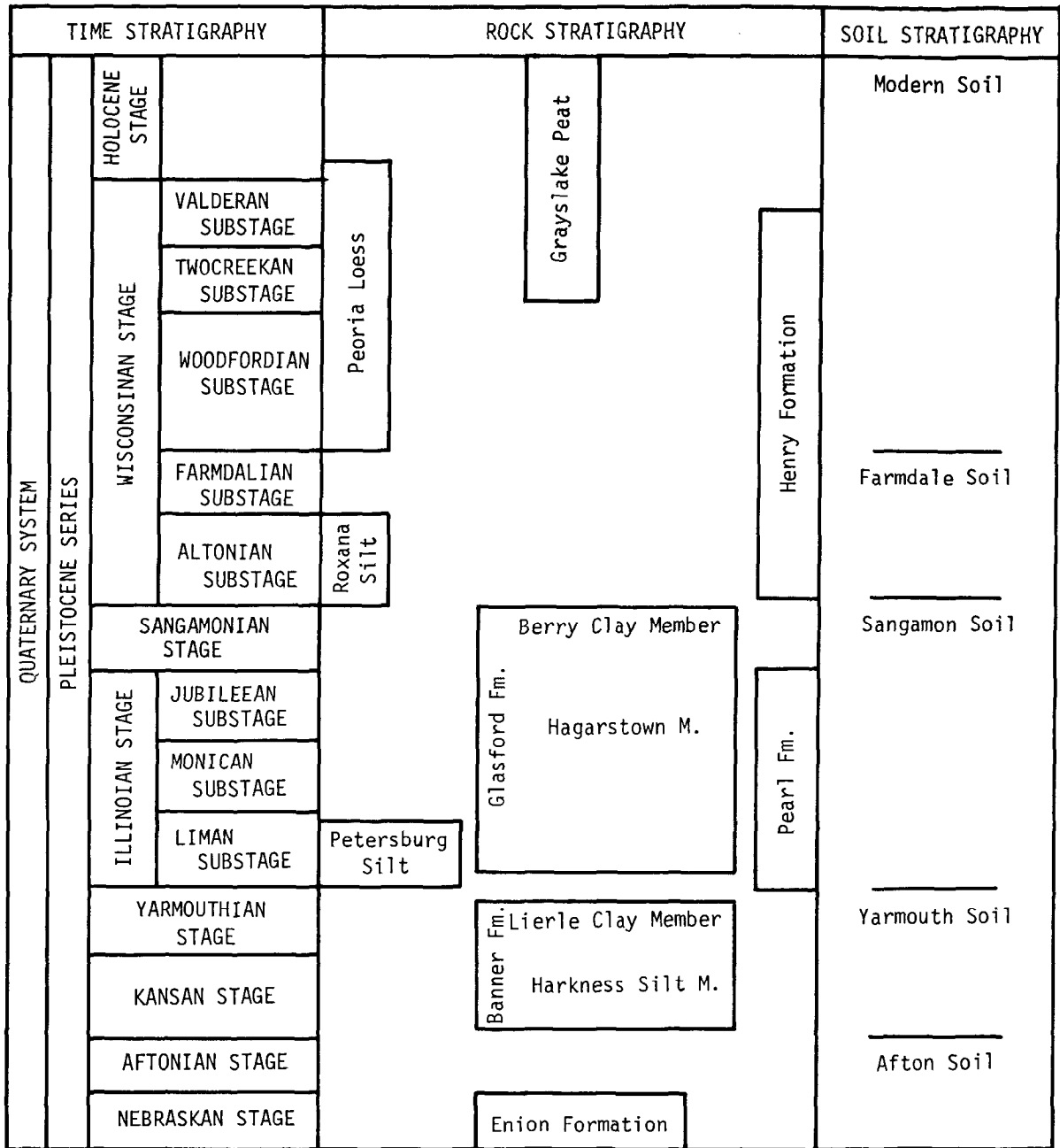

Fm. = Formation; M. = Member

(After Willman et al., 1975)

Figure 4. Time relationships of glacial periods, unconsolidated sediments, and soil development in Illinois

deposits. The retreat of the glaciers was followed by dissection of the region by streams and by soil formation. The Afton Soil is a product of this interglacial period, the Aftonian Stage.

During the Kansan glacial episode, the ice advanced into Illinois from both the northwest and northeast from two separate Canadian sources and

covered about two-thirds of Illinois. The Yarmouth Soil profile which developed on the Kansan glacial deposits after the retreat of the ice is quite thick, suggesting a long period of soil formation.

The Illinoian Stage was marked by three major glacial advances into Illinois from the northeast, which covered most of the state. The Sangamon Soil developed on the Illinoian deposits following the retreat of the ice sheets. Local accumulation of predominantly fine-grained sediments in poorly drained areas also developed on the landscape.

There were two glacial advances into Illinois during the Wisconsinan Stage. Glacial deposits were limited to northern Illinois, with large quantities of wind-blown silt, called loess, deposited over much of the rest of the state. The two advances were separated by an interval of soil formation which produced the Farmdale Soil. Radiocarbon dating indicates that the retreat of glaciers from Illinois was about 12,000 years ago. The Modern Soil has been developed on the surficial glacial deposits from that time to the present.

Stratigraphy

Soil formation is characterized by a number of processes, which, over a period of time, tend to result in the development of three soil zones or horizons. Organic material accumulates in the upper zone or A horizon and the parent material is broken down by weathering, forming soluble minerals and colloidal suspensions which are leached from the A horizon and moved to or through the underlying zone, the B horizon. Clay minerals and iron and manganese commonly are transported downward and deposited in the B horizon. The B horizon also is characterized by increasing color segregation or mottling due to alternating wet and dry conditions. The organic A horizon often is considered the zone of depletion while the B horizon is the zone of accumulation.

Carbonates are leached from the A and B horizons and usually are carried downward in the pore water into the groundwater system. In some cases, carbonate minerals accumulate in or precipitate from the pore water at the top of the lowest horizon, the C horizon, which is commonly called the parent material.

The preglacial bedrock surface in Illinois varies in age from Pennsylvanian to Cambrian. All sites studied are underlain by Pennsylvanian age rocks consisting predominantly of shale interbedded with thin sandstone, limestone, and coal layers.

Sites A and B are located in south-central Illinois in relatively flat and featureless drift plains underlain by till sheets of Kansan and Illinoian age, Illinoian water-laid deposits, and Wisconsinan loess and silts (see Figure 3). Site C is located in north-central Illinois on the floodplain of the Illinois River and is underlain by recent alluvial materials over Wisconsinan glacial outwash (Figure 3). The stratigraphy of all three sites is described in detail in the following case history sections.

SECTION 5
CASE HISTORIES

Site A

Site A is a secondary zinc smelter located in south-central Illinois. The plant started operations between 1885 and 1890, initially processed zinc ore, and was converted to a secondary zinc smelting facility about 1915. During the first 85 years wastes from the smelting operations were principally heavy metals-rich cinders and ashes. During the early years large quantities of cinders were used as road fill or surfacing for secondary roads and farm lanes in the plant area. The remainder was used as fill material around the plant buildings and as surfacing over the property. As a result of these disposal practices, there now is a 1- to 10-foot-thick layer of metals-rich cinders covering about 12 acres of the plant property.

In compliance with air pollution control regulations, a scrubber was installed on the plant stack in 1970. Prior to that time, wind-blown ash, rich in zinc and other heavy metals, was deposited on the plant site and on the surrounding farmland. This source of pollution has now been minimized, but wastewater from the scrubber is disposed of in a seepage pit constructed on the cinder materials that form the present-day land surface. Several hundred tons of high zinc content sludge have accumulated from the frequent cleaning of this pit and are being reprocessed for zinc recovery. Most of the water from the pit infiltrates into the ground underlying the plant property.

Prior to the study, it was thought that groundwater contamination might be occurring from three possible sources: a) the large volume of solid waste materials (cinders and stored junk waiting to be processed); b) the highly mineralized liquid wastes from the stack scrubbers; and/or c) the wind-blown ash from the smelter furnace prior to installation of the scrubbers. Table 1 illustrates the chemical properties of the waste materials at Site A.

Because of this facility's operation and the various sources and forms of contamination likely to be present, it was selected for detailed study. Maximum time, effort, and money were devoted to the study of this site to develop the study methodology and to optimize its application at other sites.

Altogether, 49 wells at 36 locations were completed at Site A. Core samples were taken at each of these locations and at an additional 23 sites (see Figure 5). Total well and core sampling footages are about 1309 and 1454 feet, respectively.

Geology

The glacial materials at this site range in thickness from about 55 feet on the east to about 75 feet on the west. The stratigraphic units

Table 1. Chemical Properties of Waste Materials — Site A

		<i>Cinder fill</i>	<i>Stockpiled dried sludge from disposal pit</i>	<i>Slurry from disposal pit sample</i>	<i>Supernatant liquid from disposal pit sample</i>
SiO ₂	%	29.8	0.42	0.28	
TiO ₂	%	0.52	0.01		
Al ₂ O ₃	%	10.4	1.28	2.01	
Fe ₂ O ₃	%	9.53	1.01	0.88	
MgO	%	0.92	0.29	0.08	
CaO	%	3.68	0.25	0.15	
Na ₂ O	%	0.54	0.08	0.07	
K ₂ O	%	0.91	0.20	0.14	
P ₂ O ₅	%	0.21	0.006		
Total S	%	1.22	1.14	1.03	
V ₂ O ₅	%	0.007	0.0006	0.0004	
ZnO	%	16.4	68.3	71.8	
PbO ₂	%	6.2	9.4	4.6	
Cd	µg/g	5.6	180	114	75
Cu	µg/g	1010	1079	829	0.23
Ni	µg/g	56	160	118	3.3
Mn	µg/g	498	198	202	
Hg	µg/g	0.19	2.0	1.6	
As	µg/g	46	90	75	
Sb	µg/g	160		38	
Se	µg/g	3.3		26	
Pb	µg/g				15.3
Zn	µg/g				26,000

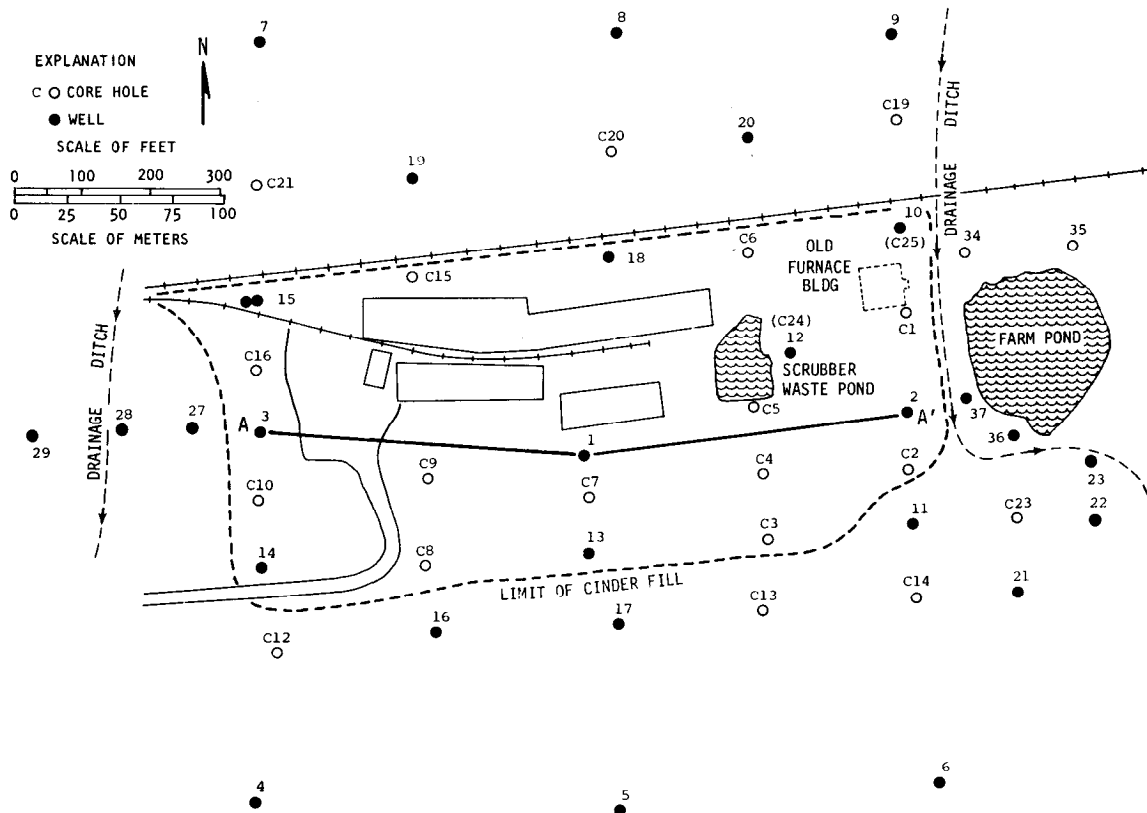

Figure 5. Location map — Site A

recognized are essentially uniform in character and thickness and generally flat-lying across the site (Figure 6). The elevation of the bedrock surface dips from 449 feet above sea level on the east to 432 feet on the west.

Data from selected borings are included in the Appendix.

Table 2 summarizes the textural and mineralogical information for each unit. A brief description of each stratigraphic unit follows.

Wisconsinan Stage

- A) Peoria Loess (4 to 6 feet thick) - Brownish-gray clayey silt. Sand content averages 4 percent. Montmorillonitic (expandable) clay minerals average 84.5 percent, and illite averages 11 percent. Consists of windblown deposits during and following Woodfordian glaciation beyond the limits of Woodfordian glaciation (Wedron Formation). The Modern Soil profile has developed in the Peoria Loess as evidenced by abundant organic material, iron stains, and absence of carbonates.
- B) Roxana Silt (0 to 5 feet thick) - Dark brown clayey silt. Average sand content 20 percent, may be as high as 34 percent. Similar to the Peoria Loess in clay mineral

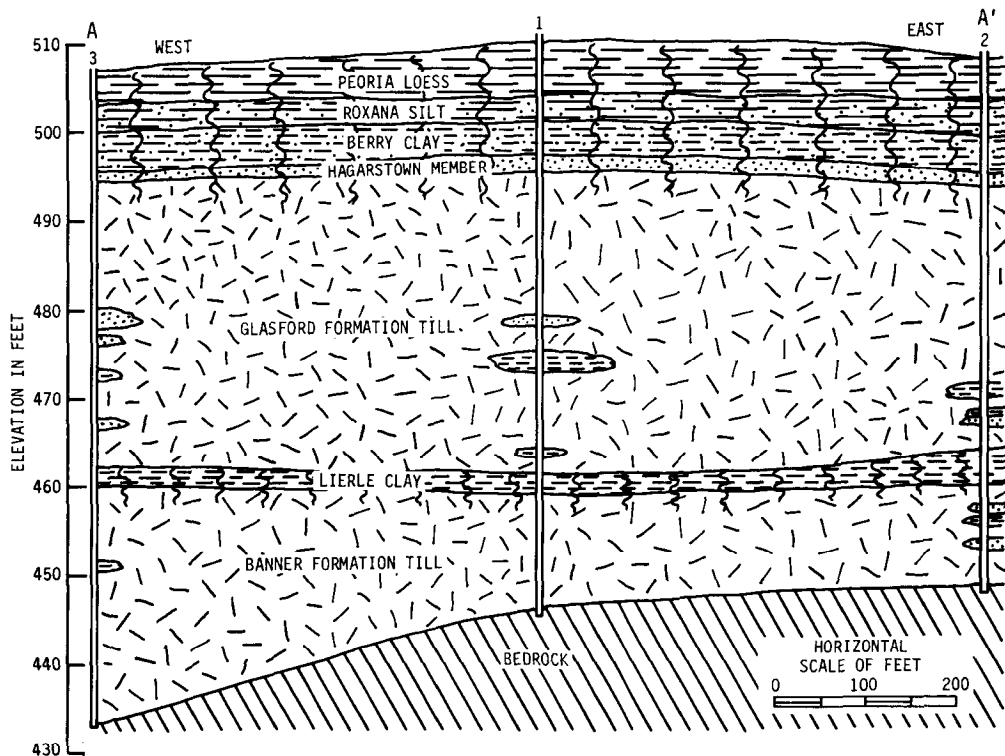

Figure 6. Stratigraphic cross section — Site A

Table 2. Textural and Mineralogical Data for stratigraphic Units – Site A

STAGE	UNIT	AVERAGE TEXTURE	AVERAGE CLAY MINERALOGY (<2 μ)	CARBONATE MINERALOGY (<2 μ)
WISCONSINAN	PEORIA LOESS	(4-59-37) 10 samples	M 84.5% I 11% 8 samples	LEACHED
	ROXANA SILT	(20-47-33) 9 samples	M 85% I 8% 7 samples	LEACHED
SANGAMONIAN	BERRY CLAY MEMBER-GLASFORD FORMATION	(33-31-36) SAND INCREASES TOWARD BASE 13 samples	M 77% I 13% 13 samples	LEACHED
ILLINOIAN	HAGARSTOWN MEMBER-GLASFORD FORMATION	(46-33-21) VARIABLE 3 samples	M 30% I 51% 3 samples	LEACHED
	GLASFORD FORMATION TILL	(31-40-29) SANDIER NEAR TOP 79 samples	M 45% INCREASES WITH DEPTH I 40% DECREASES WITH DEPTH 51 samples	CONTAINS CARBONATES MAY BE LEACHED AT TOP
YARMOUTHIAN	LIERLE CLAY MEMBER-BANNER FORMATION	(24-41-35) 8 samples	M 45% I 37% VARIABLE 6 samples	LEACHED
KANSAN	BANNER FORMATION TILL	(25-44-31) SANDIER NEAR TOP 40 samples	M 16% I 55% VARIABLE 31 samples	CONTAINS CARBONATES MAY BE LEACHED AT TOP
PENNSYLVANIAN SYSTEM	BOND FORMATION	NO INFORMATION	M 3% I 4% 2 samples	LEACHED

Note: (4-59-37), etc. = Average percentage of sand, silt, and clay excluding gravel
M 84.5%, etc. = Average percentage of montmorillonitic (expandable) minerals in clay fraction (<2 μ)
I 11%, etc. = Average percentage of illite in clay fraction

content. Distinguished from the overlying Peoria Loess by color and greater sand content. Consists of wind-blown deposits mixed with underlying material. Contains Farmdale Soil and probably part of the Modern Soil profile; it is leached and contains iron stains and organic material.

Sangamonian Stage

Glasford Formation

- C) Berry Clay Member (3 to 5 feet thick) - Dark gray sandy silty clay with a trace of gravel; distinguished from the overlying Roxana Silt by color and/or texture. Sand and gravel content increases toward the base. Clay mineral composition similar to the composition of the Peoria and Roxana materials. Considered an accretion-gley deposit produced by slow accumulation of predominantly fine-grained sediments in poorly drained areas. Development of the Sangamon Soil in the Berry Clay is evidenced by abundant organic material, iron stains, and absence of carbonates.

Illinoian Stage

- D) Hagarstown Member (1 to 2 feet thick) - Silty sand with some gravel. Clay mineral composition similar to underlying till; illite averages 51 percent and montmorillonitic clay minerals average 30 percent. Sand content variable may be up to 50 percent. In some borings, less sandy and hard to distinguish from the underlying Illinoian till. Variability of the Hagarstown and the similarity of the clay mineral composition to the underlying till suggest an ablation origin related to the melting of the glacier which deposited the underlying till. Typically leached and iron-stained, indicating that the Sangamon Soil extends through this unit.
- E) Glasford Till Member (20 to 43 feet thick) - Gray to dark gray sandy and silty glacial till. Contains carbonates except where Sangamon Soil extends into the uppermost portion. Illite over 50 percent of the clay fraction near the top of the unit, decreasing with depth. Montmorillonitic clay content increases with depth. Sand content averages 35 percent near the top and decreases to less than 30 percent near the base. Lenses of dark olive-brown leached clay are locally present, apparently sheared up from the underlying Lierle Clay (see Figure 4). Discontinuous lenses of sand and silt also are present.

Yarmouthian Stage

Banner Formation

- F) Lierle Clay Member (0 to 4 feet thick) - Dark olive-brown silty clay. Sand content averages 24 percent. Clay mineral

composition is variable. An accretion-gley; contains Yarmouthian Soil; leached and iron stained.

Kansan Stage

- G) Banner Formation Till (10 to 29 feet thick) - Gray to pinkish gray sandy silty clay till with some gravel. Carbonates are present except locally at the top. A higher illite content and lower montmorillonitic clay content than Glasford Formation Till (E). Montmorillonitic clay minerals average 16 percent and illite 55 percent of the clay fraction. Average sand content 25 percent compared with 31 percent in the Glasford Till. Shale fragments and discontinuous sand and silt lenses are present. Yarmouth Soil has developed into the till. Evidence of soil formation extends well into the till, suggesting a long period of soil formation or intense weathering.

Pennsylvanian System

- H) Bond Formation - Bedrock consisting of green shale containing abundant mica. High kaolinite and illite content and low montmorillonitic clay content. Bedrock is leached. No textural data.

At Site A, four soils are recognized in the glacial drift. In addition to the Modern Soil which has developed in the Peoria Loess and Roxana Silt, the Farmdale Soil has developed on the Roxana Silt, the Sangamon Soil on the Berry Clay and underlying Illinoian deposits, and the Yarmouth Soil on Kansan sediments. Inasmuch as the upper four units are relatively thin and contain three overlapping soil profiles, the glacial drift is leached to a depth of 12 to 15 feet. The zone of leaching typically extends into the Hagarstown or Glasford Formation Till.

Resistivity Survey. An electrical earth resistivity survey was conducted at Site A on October 21 and 22, 1974. The locations of the 35 resistivity stations are shown in Figure 7. The Wenner configuration was used in the study with a-spacings for electrodes at regular intervals ranging from 2 feet to 100 feet at most stations. The apparent resistivity values at a-spacings of 2, 5, and 30 feet at each station are shown in Figure 7. The 2-foot a-spacing was not used on the line of traverse immediately north of the railroad. Resistivity measurements within the immediate vicinity of the site were not possible because of the extensive cinder fill and the presence of conductors such as electric lines, fences, and railroad tracks. Station 26 is located in cinder fill south of the scrubber waste pond. The resistivity instrument would not read out reliable measurements at this station.

Apparent resistivity measurements at the 30-foot a-spacing are shown in Figure 7; the resistivities range from 15 to 30 ohm-meters with an average value of 22.7 ohm-meters. The apparent resistivity values measured at larger a-spacings are similar to those measured at 30 feet. From an

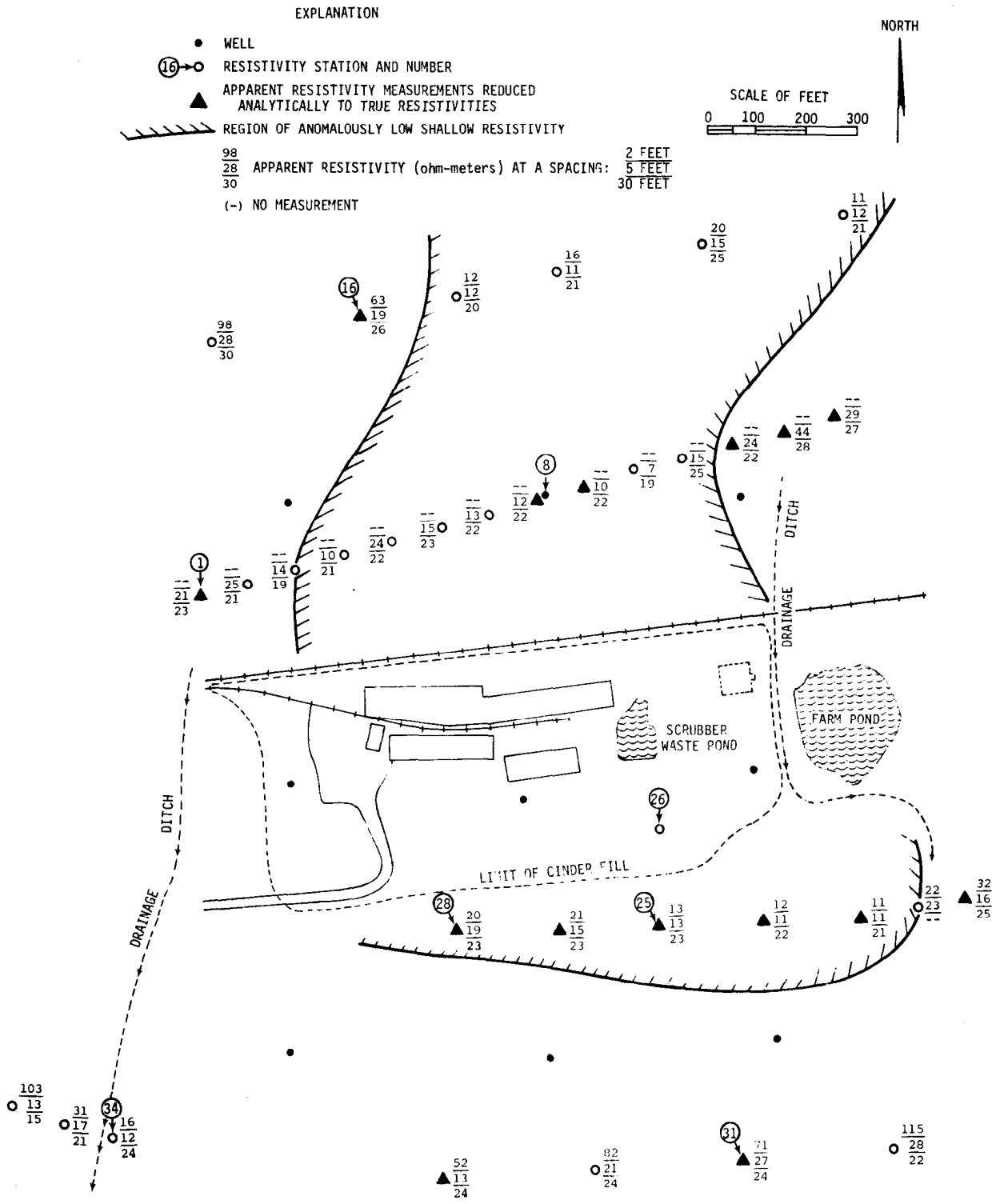

overall view, the resistivity values were uniformly low and indicate that the general region is underlain by fine-grained materials. Thick, permeable zones of sand and gravel were not detected. Extensive lateral or vertical migration of significant quantities of contaminated groundwater through the fine-grained sediments is unlikely. However, the electrical earth resistivity methods cannot reliably detect thin, shallow, silty sand lenses which locally may be pathways for the slow, lateral movement of small quantities of contaminated groundwater. The study of cores from borings at Site A shows that a thin, silty sand (Hagarstown Member of Glasford Formation) does occur locally at depths less than 15 feet.

Anomalously low, shallow resistivity values (measured at a-spacings of 2 and 5 feet) north to northeast of the smelter and south of the site appear to define a region of contamination from deposition of wind-blown materials, or possibly from dumping of material on the surface. The general region of low surface resistivities is indicated in Figure 7.

Station 34 is located in the southwestern part of the study area in the floodplain of a small stream which receives runoff from the western part of the site. The low apparent resistivity readings for a-spacings of 2 and 5 feet at this station may be due to the presence of contaminants deposited at a shallow depth along the stream.

At 15 of the resistivity stations (Figure 7) analytical methods were used to reduce the apparent resistivity values to the true resistivities of the geologic materials present at different depths. The values in Table 3 were determined for six of these stations.

The shallow high resistivity values are caused by the low conductance of unsaturated geologic materials. This shallow high resistivity layer is absent at stations located in the region of suspected surface contamination.

The extremely low resistivity values which occur in the depth interval of approximately 3 to 8 feet are due to clayey geologic materials which are saturated with water of naturally high mineral content. This low resistivity zone occurs across the entire area and cannot be related to poor quality groundwater from the industrial site. The low resistivity zone correlates with the Berry Clay Member of the Glasford Formation which is present in this depth interval.

The low resistivity zone is underlain by geologic materials with true resistivities ranging from 25 to 32 ohm-meters. These uniform low values indicate that clayey fine-grained sediments are present.

Hydrology

On the basis of the geologic description of this site, it is quite obvious that there is no significant aquifer present in the immediate vicinity of the plant site. The Hagarstown Member, a thin (1 to 2 feet thick) continuous silty sandy zone, appears to be the only permeable zone that could allow for significant lateral groundwater movement away from the site. To develop even a domestic water supply from this sand unit probably would require the construction of two or more large-diameter bored wells.

Table 3. True Resistivity Values for Six Stations – Site A

Station	Depth interval (ft)	Thickness (ft)	True resistivity (ohm-m)
1	0-2.2	2.2	43
	2.2-3.2	1.0	22
	3.2-7.6	4.4	8
	7.6-30	22.4	29
8	0-3	3	12
	3-5	2	9
	5-8	3	15
	8-34	26	30
16	0-1.4	1.4	105
	1.4-2	0.6	32
	2-5	3	8
	5-55	50	32
25	0-1.0	1	12
	1.0-2.2	1.2	19
	2.2-9	6.8	10
	9-37	26	30
28	0-1.6	1.6	21
	1.6-7.5	5.9	17
	7.5-60	52.5	27
31	0-1.8	1.8	97
	1.8-4.8	3	11
	4.8-32	27.2	25

To determine the hydrologic characteristics of this unit, a pumping test with 3 observation wells was conducted at well site 2 on August 12, 1975. Well 2S (S = shallow well) was pumped for a period of 3 hours at rates from 0.180 to 0.111 gallons per minute. Observation wells 1, 2, and 3 were located 7.2, 14.0, and 28.0 feet north of the pumped well, respectively. All drawdown data were adjusted to the final pumping rate (0.111 gpm) for analysis purposes.

Adjusted time-drawdown data for observation wells 1 and 2 were plotted on log-log graph paper (see Figure 8a and b). Adjusted distance-drawdown data for observation wells 1, 2, and 3 at 180 minutes also were plotted on log-log graph paper (see Figure 8 c). These curves were matched to the nonleaky artesian formula presented by Walton (1962):

$$s = (114.6Q/T) W(u)$$

where: s = drawdown in observation well, in feet
 Q = discharge, in gpm
 T = coefficient of transmissivity, in gpd/ft
 u = 2693 r² S/Tt, where r = distance from observation well to pumped well, in ft; S = coefficient to storage, fraction; and t = time after pumping started, in minutes

$$W(u) = \int_u^{\infty} e^{-u}/u du$$

The average computed coefficients of transmissivity, hydraulic conductivity, and storage are 285 gpd/ft, 190 gpd/ft², and 0.00128, respectively. Deviations between the early adjusted drawdown data and the type curve are probably due to the effect of removing stored water from the casing of

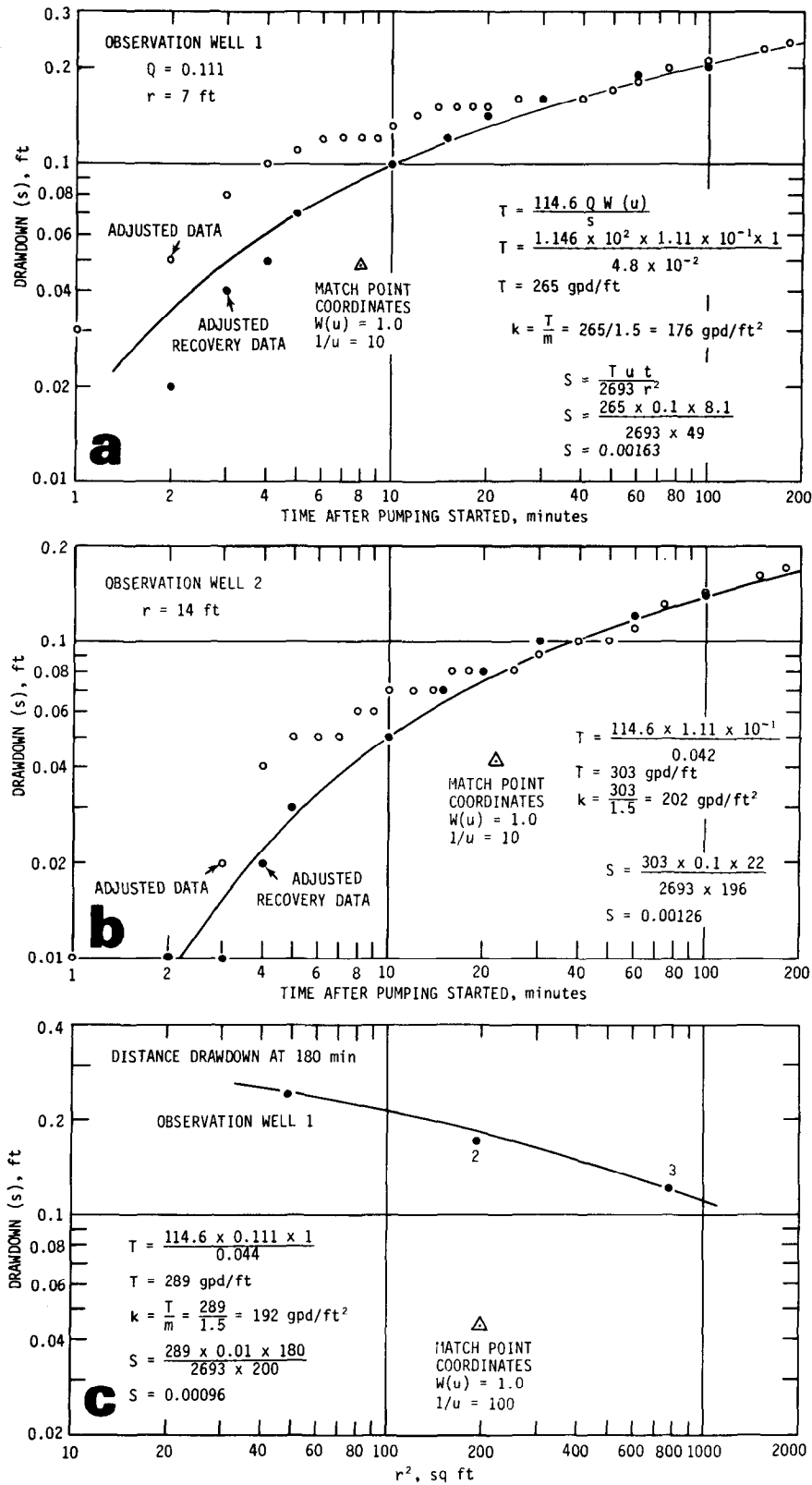

Figure 8. Pumping test data for well 2S — Site A

the pumped well. For this reason, heavy emphasis was placed on matching recovery data and late pumpage data to the type curve.

Water level hydrographs for all shallow wells at Site A are presented in Figure 9. Also included are graphs of precipitation and the zinc plant water consumption for the period of record. The hydrographs generally can be divided into those for three types of wells: a) upland type wells responding to precipitation -- see wells CH 1S (CH = control hole), 4S, 5S, 7S, 21, and 29; b) wells in lowland areas and responsive to precipitation -- see wells 16, 19, 20, and 23; and c) wells responding to the liquid disposal activity of the plant -- see wells 2S, 10S, 12, and 18. Maximum and minimum water levels for all shallow wells are summarized in Table 4.

Table 4. Range of Water Level Fluctuations in Shallow Wells – Site A

Well	Land surface elev (ft)	Low			High			Fluctuation (ft)
		Depth below land (ft)	Mean sea level (ft)	Date	Depth below land (ft)	Mean Sea level (ft)	Date	
1S	507.08	2.05	505.03	11-18-75	0.73	506.35	3-20 -75	1.32
2S	507.83	6.10	501.73	7-13-76	4.15	503.68	1-9-75	1.95
3S	505.60	2.80	502.80	10-1-76	0.22	505.38	3-20-75	2.58
4S	506.87	4.64	502.23	10-1-76	1.51	505.36	5-20-75	3.13
5S	507.07	4.32	502.75	11-18-75	1.31	505.76	3-2-76	3.01
6S	510.51	9.43	501.08	10-1-76	2.97	507.54	4-8-76	6.46
7S	506.78	5.63	501.15	10-1-76	2.36	504.42	3-2-76	3.27
8S	506.13	2.75	503.38	7-29-76	2.38	504.75	3-2-76	0.37
9S	504.39	3.84	500.55	10-1-76	1.78	502.61	4-8-76	2.06
10S	504.16	1.34	502.82	8-12-75	0.23	503.93	7-22-75	1.11
11	507.82	6.99	500.83	10-1-76	4.51	503.31	4-8-76	2.48
12	508.87	5.52	503.35	7-13-76	4.05	504.82	7-22-75	1.47
13	507.00	3.29	503.71	11-18-75	2.25	504.75	7-22-75	1.04
14S	504.45	2.79	501.66	10-1-76	0.88	503.57	7-22-75	1.91
15S	508.92	4.89	504.03	10-1-76	2.13	506.79	7-22-75	2.76
16	505.81	3.30	502.51	10-1-76	1.53	504.28	4-8-76	1.77
17	505.89	2.89	503.00	10-1-76	1.47	504.42	3-2-76	1.42
18	510.14	5.30	504.84	7-13-76	3.22	506.92	7-22-75	2.08
19	506.24	3.35	502.89	10-1-76	1.38	504.86	3-2-76	1.97
20	504.98	2.21	502.77	10-1-76	1.28	503.70	3-2-76	0.93
21	509.04	7.93	501.11	10-1-76	5.02	504.02	4-8-76	2.91
22	503.50	4.19	499.31	10-1-76	1.54	501.96	3-2-76	2.65
23	502.64	2.60	500.04	10-1-76	1.31	501.33	9-24-75	1.29
24	500.79	3.13	497.66	10-1-76	0.20	500.59	9-24-75	2.93
25	500.37	3.61	496.76	10-1-76	0.11	500.26	3-2-76	3.50
26	499.30	4.40	494.90	10-1-76	0.61	498.69	3-2-76	3.79
27	505.29	3.54	501.75	10-1-76	1.31	503.98	3-2-76	2.23
28	503.82	3.05	500.77	10-1-76	0.22	503.60	4-8-76	2.83
29	505.59	5.12	500.47	10-1-76	1.23	504.36	4-8-76	3.89
30	500.65	3.54	497.11	10-1-76	0.15	500.50	3-2-76	3.39
31	499.54	3.90	495.64	10-1-76	1.10	498.44	4-8-76	2.80
32	498.44	3.32	495.12	10-1-76	0.13	498.31	4-8-76	3.19
33	497.92	3.83	494.09	10-1-76	0.36	497.56	4-8-76	3.47
36	503.47	4.13	499.34	9-9-76	1.15	502.32	7-29-76	2.98
CH 1S	486.00	7.49	478.51	10-1-76	1.96	484.04	5-20-75	5.53

S = shallow; CH = control bole

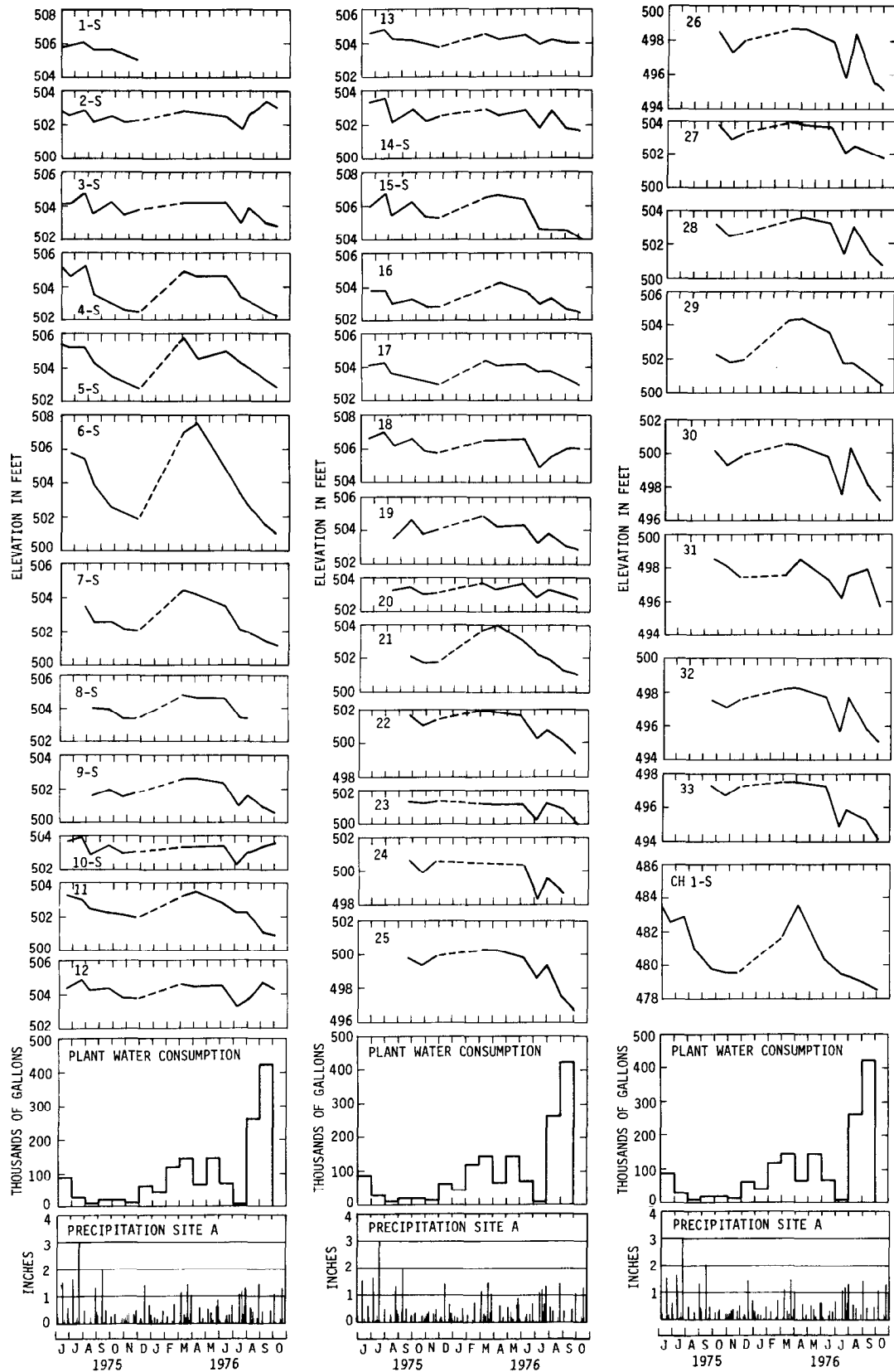

Figure 9. Water level hydrographs for shallow wells — Site A

Piezometric surface maps were drawn for each round of water level measurements made. Figures 10a and b for March 1976 and November 1975 illustrate the high and low water level elevations, respectively. In both instances there is a groundwater mound beneath the plant site, and movement of water is in all directions away from the plant complex. The relatively high hydraulic conductivity of the fill materials at the plant site, its topographic setting (higher than the surrounding land), and the liquid disposal activity of the plant all contribute to the development of this recharge mound.

Water level hydrographs for all deep wells at Site A are presented in Figure 11. It should be noted that water levels in wells 5D (D = deep well), 6D, 7D, and 8D took approximately 15 months to stabilize. This was due to the relatively impermeable materials these wells were completed in. Wells 1D, 2D, 3D, 4D, and 9D were completed in sandier units and therefore were reflecting stabilized water levels within 1 or 2 months. Because of the slow recovery rates of some deep wells, they were not sampled monthly as were the shallow wells. The dots in Figure 11 indicate when samples were collected. The decline in water levels after sampling is obvious in data from wells finished in the less permeable units. Maximum and minimum water levels for all deep wells are summarized in Table 5.

As a result of the problem of not having stabilized water levels in some of the deep wells for the period of record, monthly piezometric surface maps were not drawn. An estimated piezometric surface map for deep wells is presented in Figure 12. In general, water levels in the deep wells are higher than those in the shallow wells, indicating a probable upward movement of water within the glacial drift sequence. In the immediate plant area, where the shallow water levels are mounded, water in the shallow deposits probably is moving downward and horizontally while water in the deeper units probably is moving upward and horizontally.

The rate of groundwater movement in the shallow deposits was calculated for the immediate plant area with Darcy's equation $v = PI$ where v = apparent or bulk velocity, P = hydraulic conductivity, and I = hydraulic gradient. The actual or effective velocity is described by Hantush (1964) as the apparent velocity divided by the effective porosity of the soil or aquifer. The effective porosity is the portion of pore space in a saturated permeable material in which flow of water takes place. Not all of the pore space of a material filled with water is open for flow, since part of the void is filled with water that is held in place by molecular and surface water tension forces. The porosities of the aquifer materials (Hagarstown Member) at Site A were measured to be 0.32. On the basis of data presented by Todd (1967), an effective porosity or specific yield of 0.10 was assumed. With this value, effective velocities of 1.7 and 1.9 ft/day or 620 to 690 ft/year were calculated for the mounded area of the plant in March 1976 and November 1975, respectively.

These unexpected high rates of movement can be explained by the relatively steep hydraulic gradients developed beneath the plant complex. Similar calculations in areas removed from the influence of the recharge mound resulted in average effective velocities of 0.15 to 0.40 ft/day or 55 to 145 ft/year.

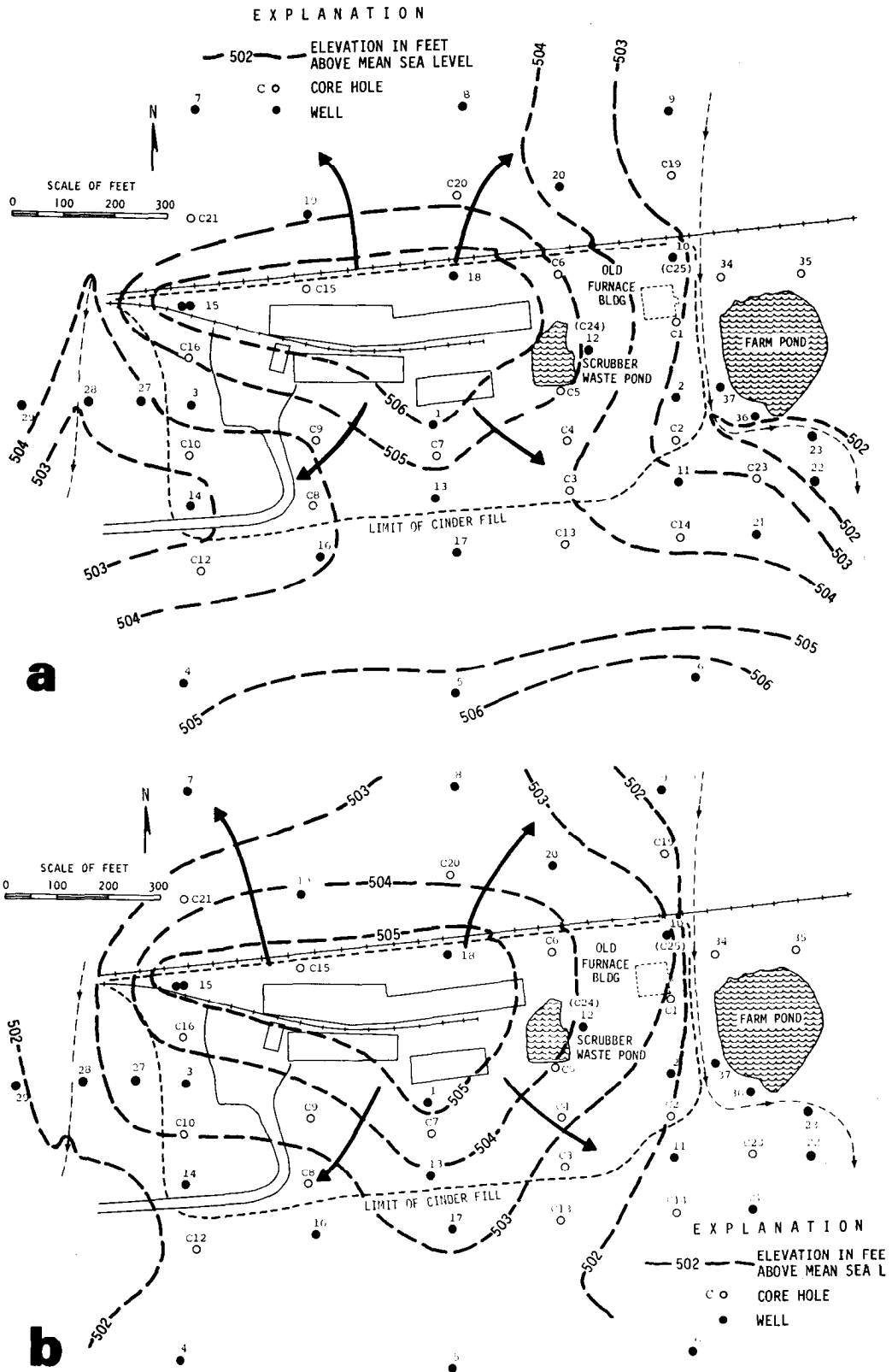

Figure 10. Piezometric surface maps for a) March 1976, and b) November 1975, for shallow wells at Site A

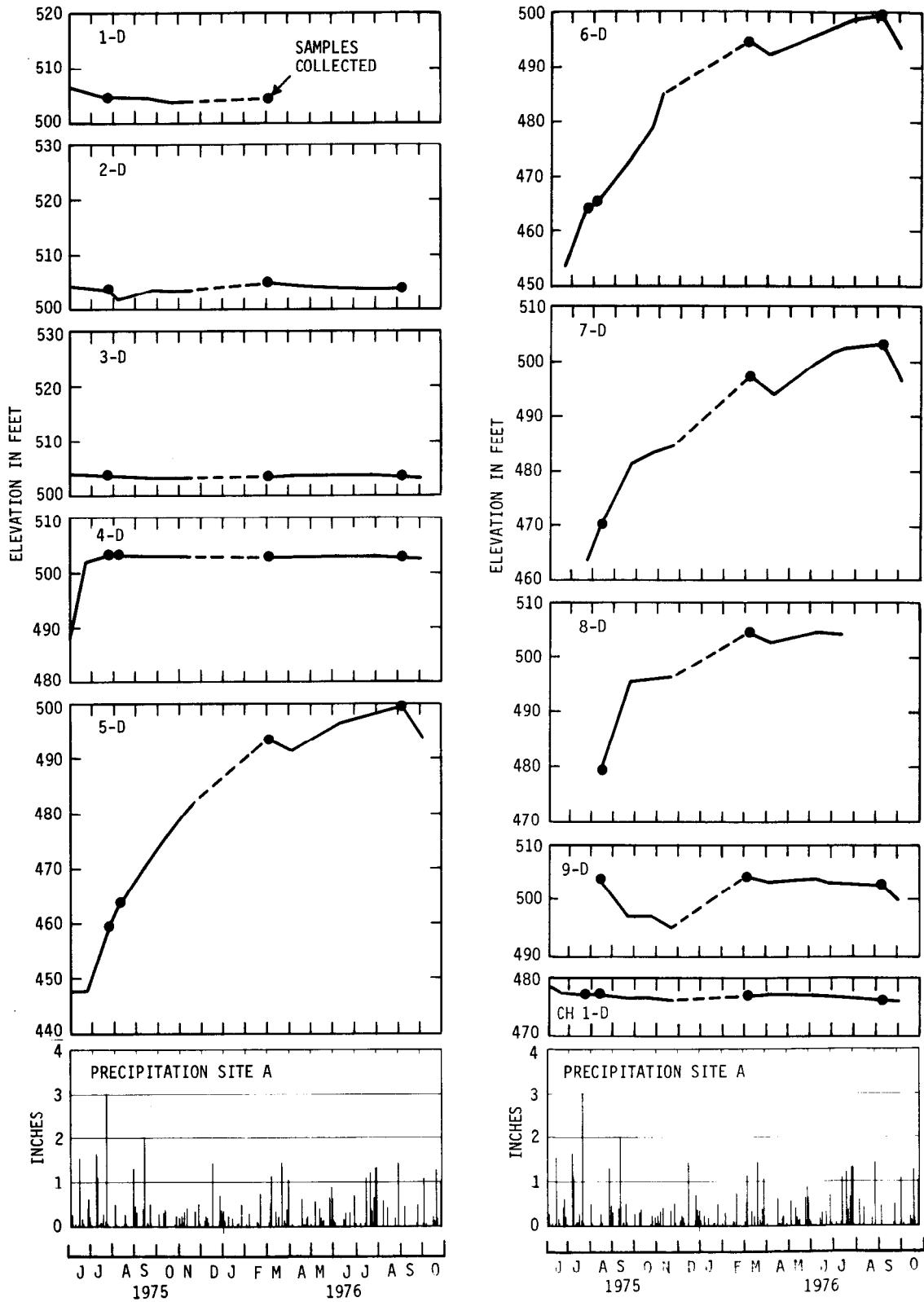

Figure 11. Water level hydrographs for deep wells – Site A

Table 5. Range of Water Level Fluctuations in Deep Wells – Site A

Well	Land surface elev (ft)	Low			High			Fluctuation (ft)
		Depth below land (ft)	Mean sea level (ft)	Date	Depth below land (ft)	Mean sea level (ft)	Date	
1D	507.08	3.11	503.97	11-18-76	0.87	506.21	5-20-76	2.24
2D	507.83	4.50	503.33	1-9-75	2.87	504.96	3-2-76	1.63
3D	505.60	3.98	501.62	1-9-75	1.92	503.68	5-20-76	2.06
4D	506.87	25.21	481.66	5-20-75	4.12	502.75	7-20-75	21.09*
5D	507.07	59.40	447.67	5-20-75	7.61	499.46	9-9-76	51.79*
6D	510.51	56.75	453.76	6-18-76	10.96	499.55	9-9-76	45.79*
7D	506.78	43.22	463.56	7-22-75	3.60	503.18	9-9-76	39.62*
8D	506.13	26.72	479.41	8-13-75	1.58	504.55	6-8-76	25.14*
9D	504.39	8.70	495.69	11-18-75	-0.41	504.80	3-2-76	9.11
CH 1D	486.00	9.56	476.44	10-1-76	6.61	479.39	5-20-75	2.95

Water levels not stabilized
 D = deep; CH = control bole

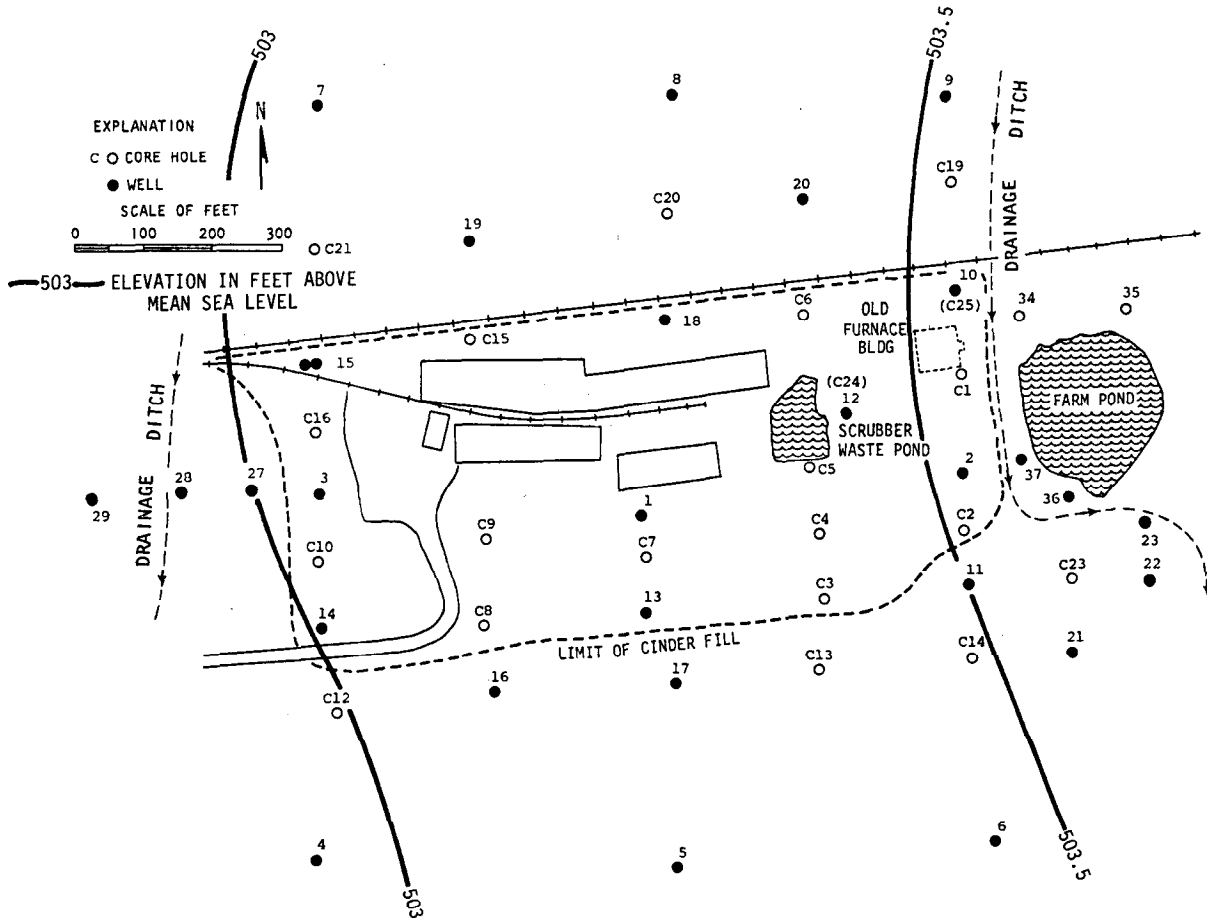

Figure 12. Estimated piezometric surface map for deep wells - site A

A soil temperature survey was conducted at Site A by the Illinois State Geological Survey on April 16 and 17, 1975.

The locations of the 58 stations used in this survey are shown in Figure 13. Temperature measurements were made in degrees Fahrenheit at a depth of 2.3 feet below land surface. Lines of equal temperature on a contour interval of 1 degree Fahrenheit are shown. A halo of high temperature was measured surrounding the smelter. Direction of shallow groundwater flow away from the smelter may be interpreted from the lateral changes in the soil temperatures. Inferred lines of groundwater flow are shown in Figure 13. Flow appears to be west to southwest, east to southeast, and north from the site. The groundwater flow to the north discharges in the low ground immediately north of the railroad. The temperature survey indicates very little groundwater flow to the south of the site. Flow in this direction is restricted by the low swale just south of the plant property.

The shallow flow system interpreted from soil temperature measurements is similar to that interpreted from the piezometric surface map for shallow wells at this site.

Chemical Data

In addition to the analyses of data for detailed geologic interpretation, chemical analyses of the core samples were conducted to define: a) the vertical and horizontal migration patterns of chemical contaminants through the soil, and b) the residual chemical buildup in soils in the vicinity of the pollution source. Results of selected chemical analyses conducted on soil core samples are included in the Appendix.

Preliminary analyses of core samples during the early stages of the study indicated that four elements (zinc, cadmium, copper, and lead) were most likely to be carried into the soils and groundwater system beneath the plant property. As a result, these elements were selected for routine analytical determinations.

Results of chemical analyses of core samples from the Site A control hole location approximately 3 miles south-southwest of the plant and samples from unaffected soil horizons beneath the plant property suggest that background concentrations for the four elements tested should be about 20 to 50 mg/l for zinc, 0.04 to 1.5 mg/l for cadmium, 10 to 30 mg/l for copper, and 10 to 40 mg/l for lead. There appears to be no significant chemical variation with depth or between geologic unit boundaries. Some zinc levels in isolated Pleistocene soils were higher.

To outline the limits of migration of these metals beneath the plant and give an indication of the effectiveness of the soils in retaining these metals, a series of cross sections showing zinc concentrations of the soil were prepared. The west-to-east cross sections are shown in Figure 14. On the north side of the railroad tracks rather small quantities of zinc were found in the upper 3 to 5 feet of the soil profile (see cross sections 1-1' and 2-2'). Most of the zinc introduced into this area probably was from wind-blown dust and ashes from the plant stack. The area of greatest

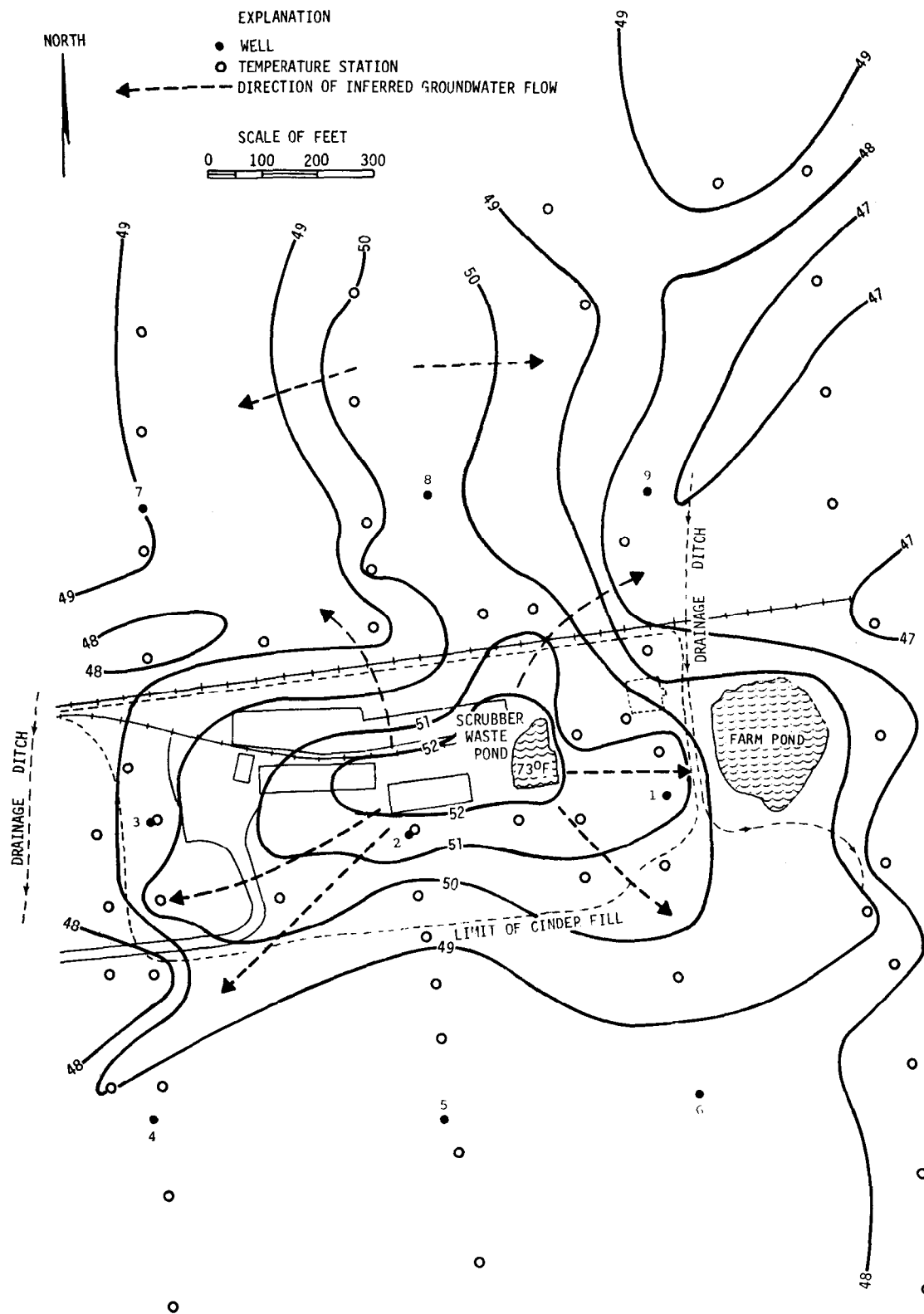

Figure 13. Soil temperature stations and results — Site A

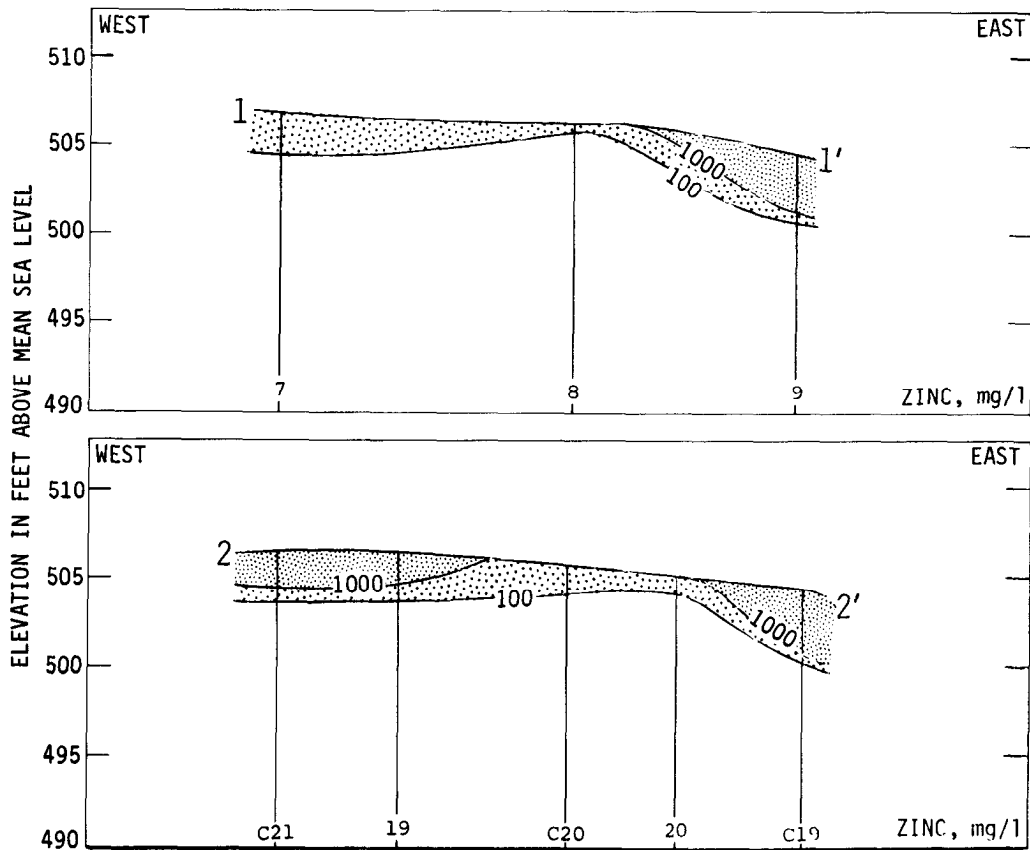
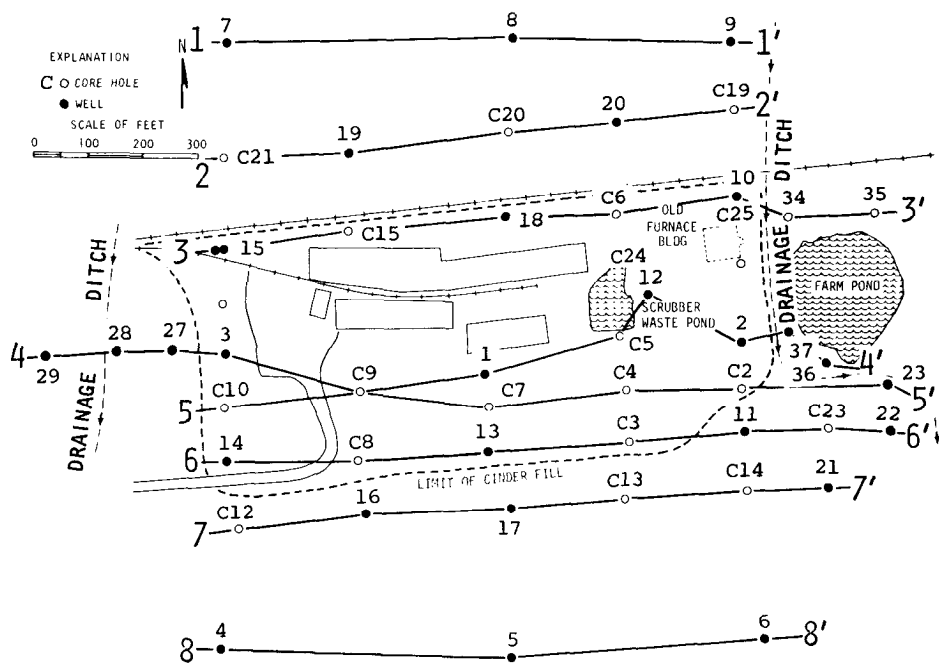

Figure 14. West-east profiles of zinc concentrations in soil — Site A

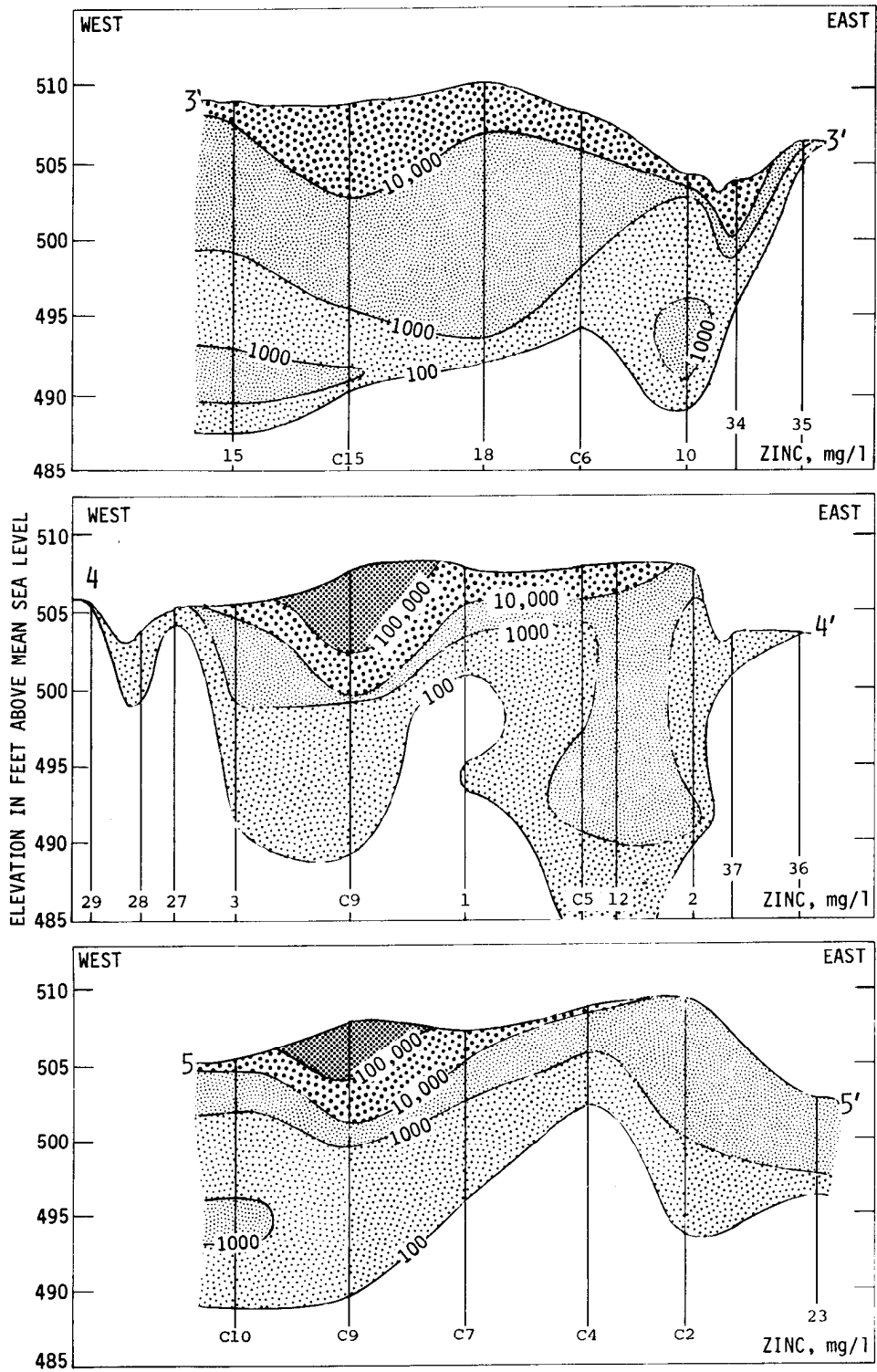

Figure 14. Continued

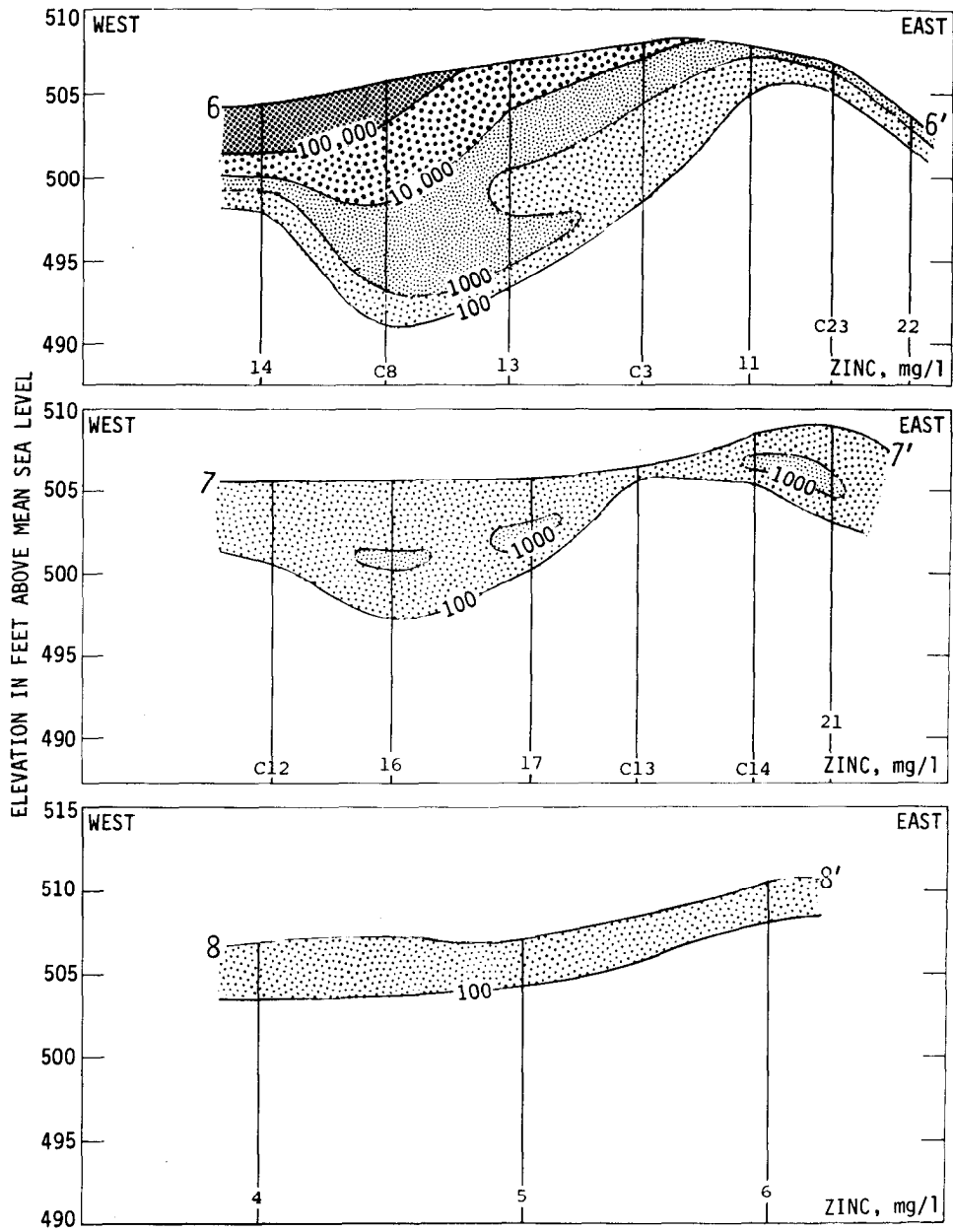

Figure 14. Concluded

accumulation and deepest penetration of zinc in the soil occurred immediately beneath the plant property (see cross sections 3-3', 4-4', 5-5', and 6-6'). Two principal sources of pollution, the cinders covering the plant property and the scrubber wastewater, have resulted in large quantities of zinc moving into the soil profile. The effect of the scrubber wastewater discharge is obvious in cross section 4-4'. Beneath well 12 the depth of penetration (to the 100 mg/l boundary) is approximately 28 feet. However, it is interesting to note that lateral migration due to this activity has still been very limited. It also is worth noting that no significant lateral migration has taken place beyond the two drainage ditches bounding the plant on the west and east. Farther south, beyond the limits of the cinder covered portion of the plant property, very limited zinc penetration has occurred (see cross sections 7-7' and 8-8').

The north-south cross sections shown in Figure 15 also indicate that significant residual soil zinc concentrations are limited to the immediate area beneath the plant property.

Similar cross sections illustrating the buildup of cadmium, copper, and lead were prepared for this site. The general shapes of these cross sections are similar to those for zinc. The depth of penetration of cadmium is slightly less than that of zinc but considerably greater than that of copper and lead. Figure 16 shows the general buildup of cadmium in the soil for two cross sections through the plant property.

Figures 17 and 18 illustrate the same two cross sections for copper and lead, respectively. The very shallow depths of penetration of these elements substantiate results of laboratory studies by Frost and Griffin (1977) indicating the relative immobility of these metals. In general, the areas of greatest penetration of the four elements occurred beneath the scrubber wastewater pit, where the wastewater is a significant source of the metals and the recharge into the soil system is greatest. In areas removed from the pit, the presence of the cinders becomes the dominant source and lowland areas where ponded water accumulates is the secondary source.

In addition to the direct percolation of metals-rich water at the plant site, a significant amount of contaminated surface water runs off the plant property and percolates into the stream beds draining the plant to the southwest and southeast. An accumulation of metals-rich cinder-type sediments in the streambed was noted. The retention of metals by the soil beneath the streambeds is illustrated in Figure 19. The concentration of metals retained and the depth of penetration decreases as the distance from the plant site increases. The exact location of core sampling with respect to the centerline of the stream bed can account for significant variations in the recorded chemical constituents in the soil. Where possible, core samples should be taken in the center of the stream bed to obtain comparable results from hole to hole.

The mechanisms retaining the metals in the soil profile at Site A are predominantly cation exchange and precipitation of insoluble metal compounds as a result of pH change. Cation exchange capacity data indicate little variation in the retention capabilities of the upper geologic units--the silts, clays, and tills. Therefore, as metals-rich water

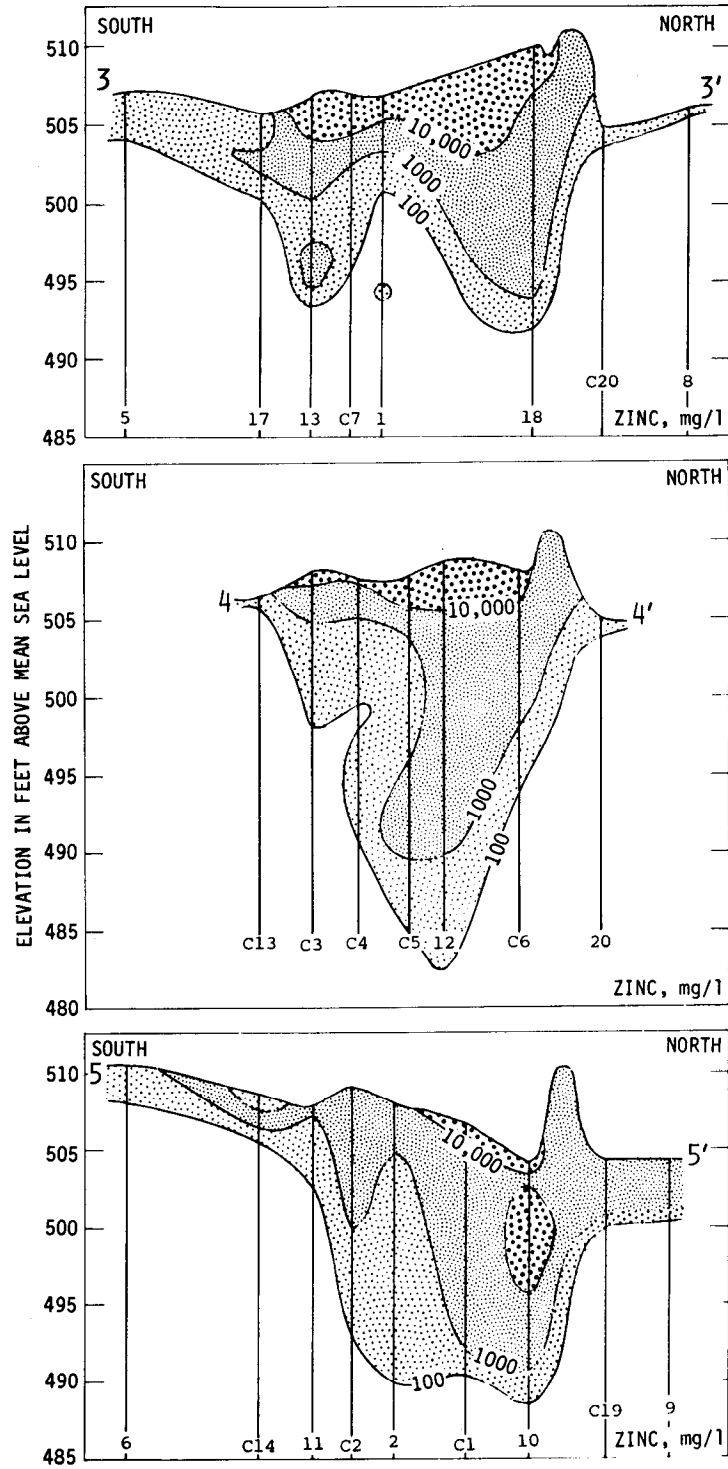
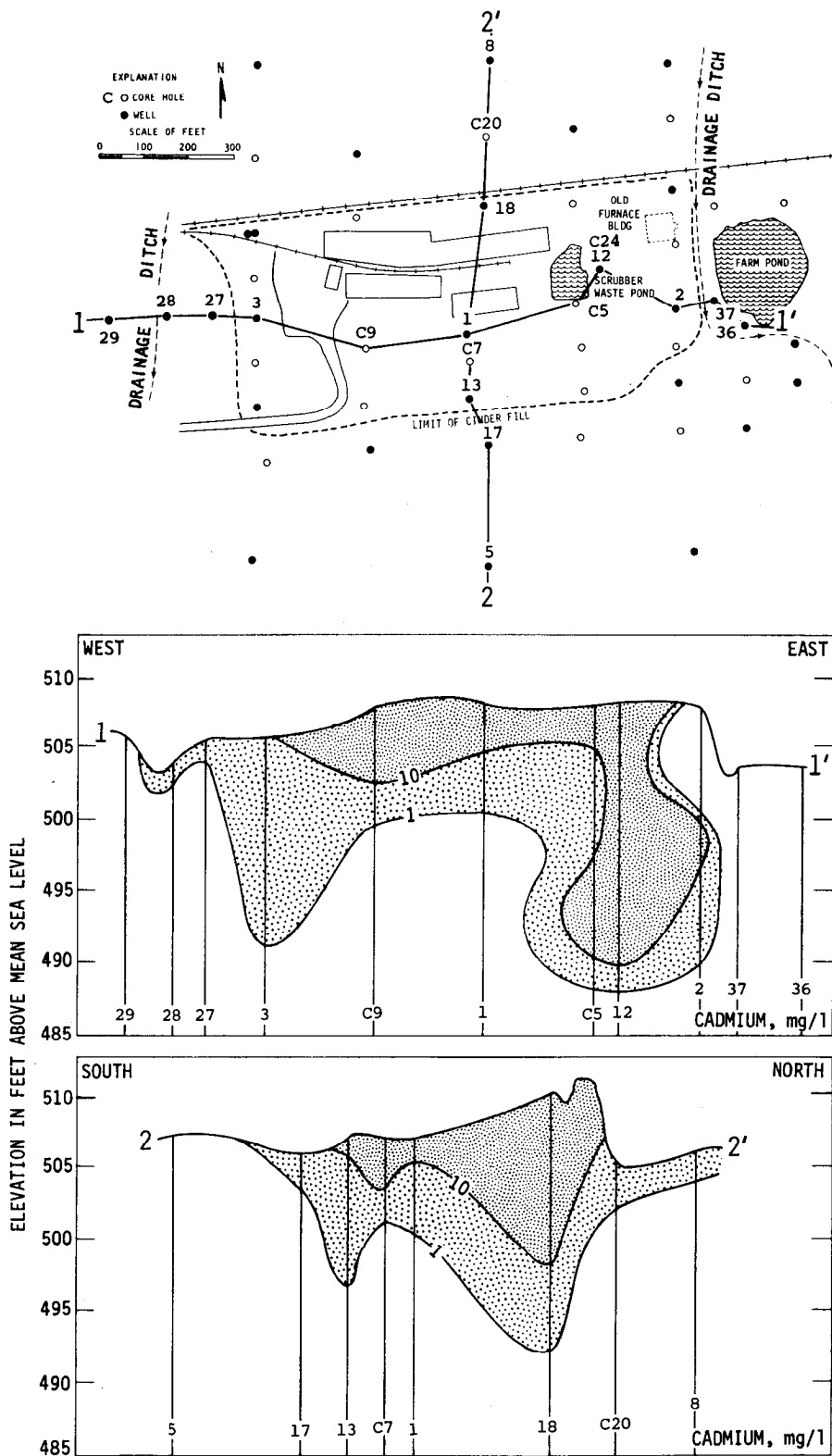

Figure 15. Concluded



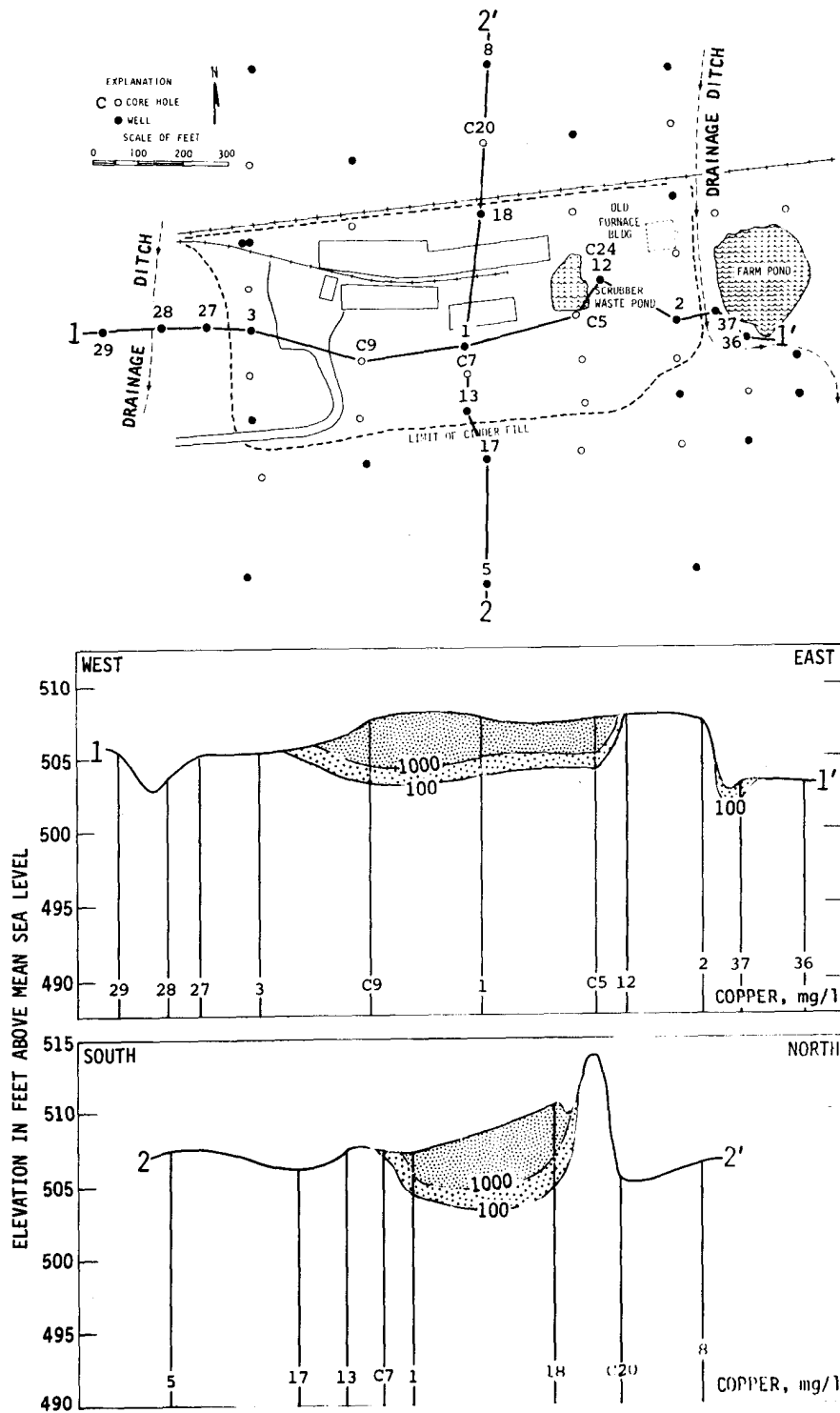

Figure 17. Profiles of copper concentrations in soil - Site A

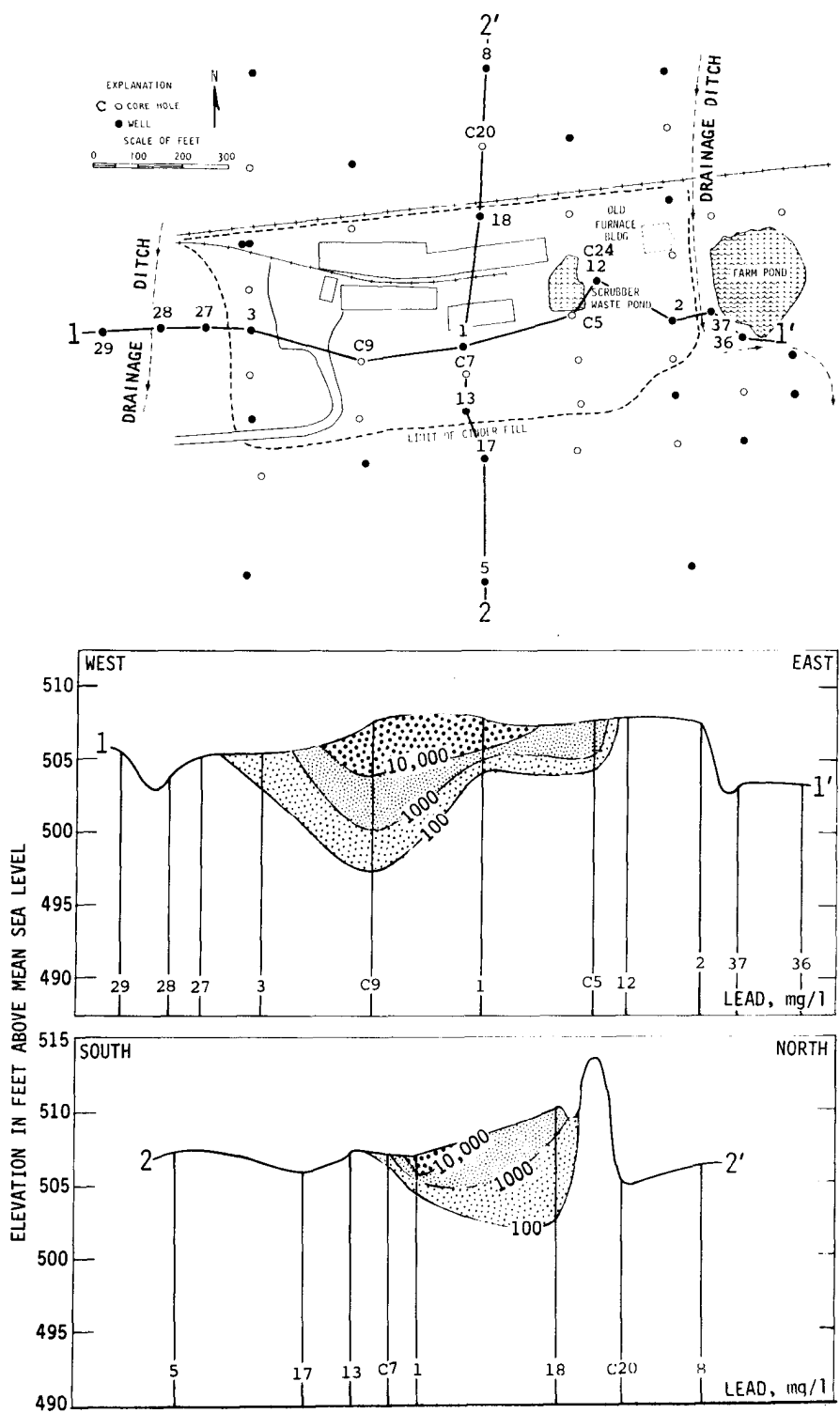

Figure 18. Profiles of lead concentrations in soil - Site A

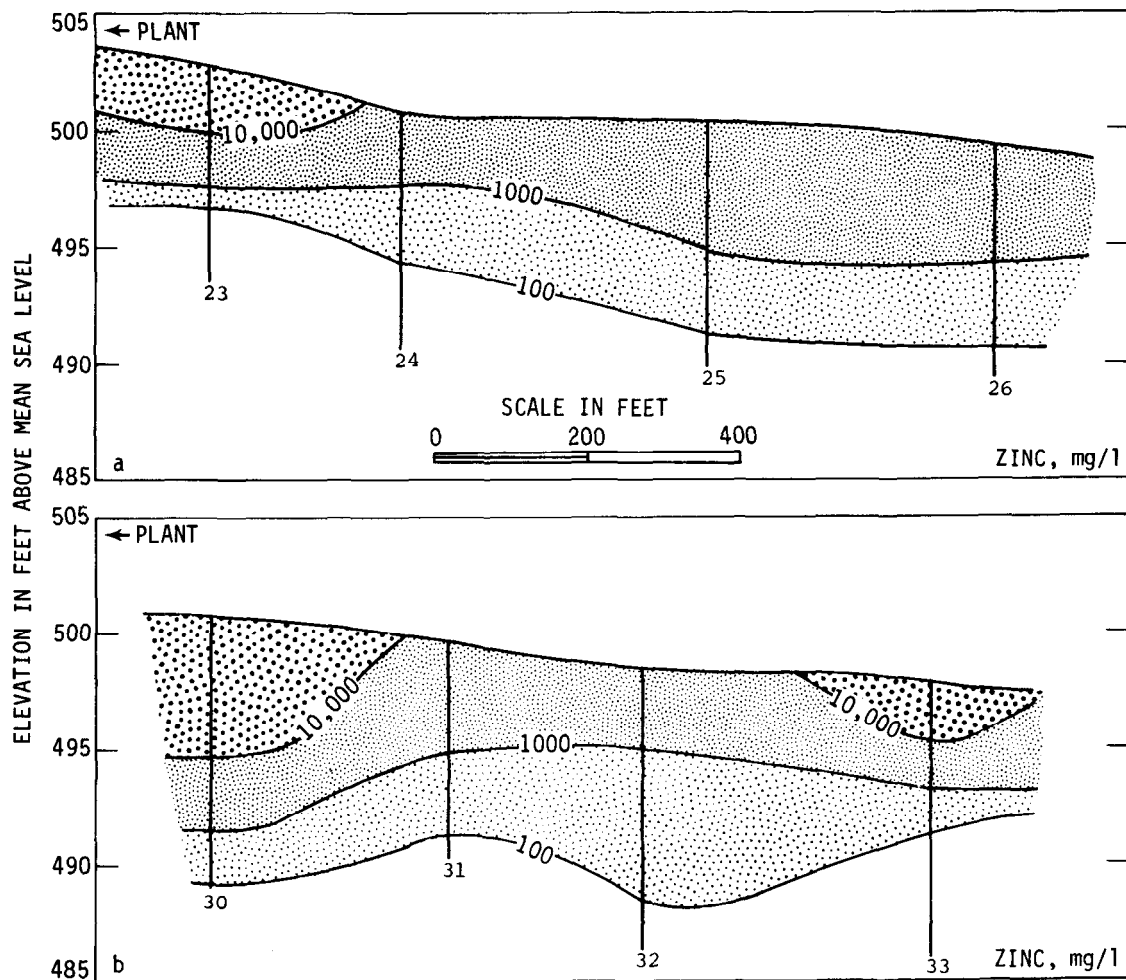

Figure 19. Profiles of zinc concentrations in stream bed soil — Site A

percolates downward through the soil profile, the metals are exchanged roughly in reverse order of their mobility.

Measured cation exchange capacities (CEC) of soils at Site A range from about 4 to 10 me/100 grams with the larger values occurring in the shallower soils. If zinc were transferred onto the available exchange sites of the soil, cation exchange could account for soil zinc concentrations up to about 3500 mg/l. This value could be higher, because the measured CEC may be lower than the original capacity of the soil.

Aside from that possibility, three other factors can be used to explain the difference between the very high zinc concentrations shown in the upper part of the soil profiles and the values attributable to cation exchange:

- 1) Some of the very high values obtained for the surface and near surface samples actually are chemical results of cinder fill samples.

- 2) Immediately beneath the cinder fill, fine-grained sediments from the cinders have been illuviated into the underlying soil, also resulting in high zinc values of those samples.
- 3) Soluble and insoluble salts of zinc and other metals may be temporarily stored in the aerated zone during dry periods, waiting for eventual migration downward with later recharge events.

As the cation exchange capacity of the soil is exhausted and sufficient depth is reached to eliminate the three factors just noted, the metals buildup in the soil slowly continues to advance deeper into the soil profile. As this process occurs, calcium and magnesium are released into the water from the soil, and the pH of the soil is lowered. When a depth is reached where the soil has not been leached, the pH increases, resulting in the formation of zinc precipitates and a sharp break or decrease in soil zinc content. At Site A, the alteration of soil pH in the upper geologic units was enhanced by the character of the infiltrating fluid. Samples of water collected after percolating through the cinder fill materials forming the sides of the disposal pit had measured pH values near 5. It can be assumed that the same pH was experienced by water filtering downward through the cinder fill covering the plant surface. It is possible that sulfur in the cinders was being oxidized and dissolved to form sulfuric acid, thus creating the low pH and increasing the mobility of the zinc.

The conclusions drawn from this field study with regard to the mechanism of zinc and other metals fixation are in agreement with the results of laboratory studies by Frost and Griffin (1977). They conclude that increased removal of metals from solution occurs "with increasing pH values and with increasing concentrations of the heavy metal in solution."

Representative adsorption isotherms for zinc, copper, and cadmium developed by Frost and Griffin (1977) are shown in Figure 20. A marked increase in adsorption occurred for all three ions as the pH increased. The curves for zinc adsorption show sharp increases in gradient at about 250 and 100 mg/l at pH 6.75 and 7.0, respectively. The cadmium curves show sharp increases in gradient at about 40 and 5 mg/l at pH 6.5 and 7.0, respectively. A sharp change in the slope of an adsorption isotherm may be indicative of the initiation of precipitation.

Adsorption isotherms obtained for pure montmorillonite clays at pH 5.0, developed by Frost and Griffin (1977), are presented in Figure 21. Curve A illustrates the amount of Cd, Zn, or Cu adsorbed by montmorillonite from pure $\text{Cd}(\text{NO}_3)_2$, $\text{Zn}(\text{NO}_3)_2$, or $\text{Cu}(\text{NO}_3)_2$ solutions that were adjusted to pH 5.0. Curve B illustrates the data obtained when using landfill leachate. Maximum adsorption occurred in the pure solutions, whereas adsorption in the leachate was much lower because of competition by organics and other metals in solution, and organic complexing of the metals. The field situations discussed in this paper lie somewhere between these extremes, and probably closer to the pure solution than the leachate. In studies by Griffin et al. (1976) montmorillonite adsorbed approximately 5 times more metals than other clays under similar conditions. It has already been noted that the soils at Site A are montmorillonite-rich.

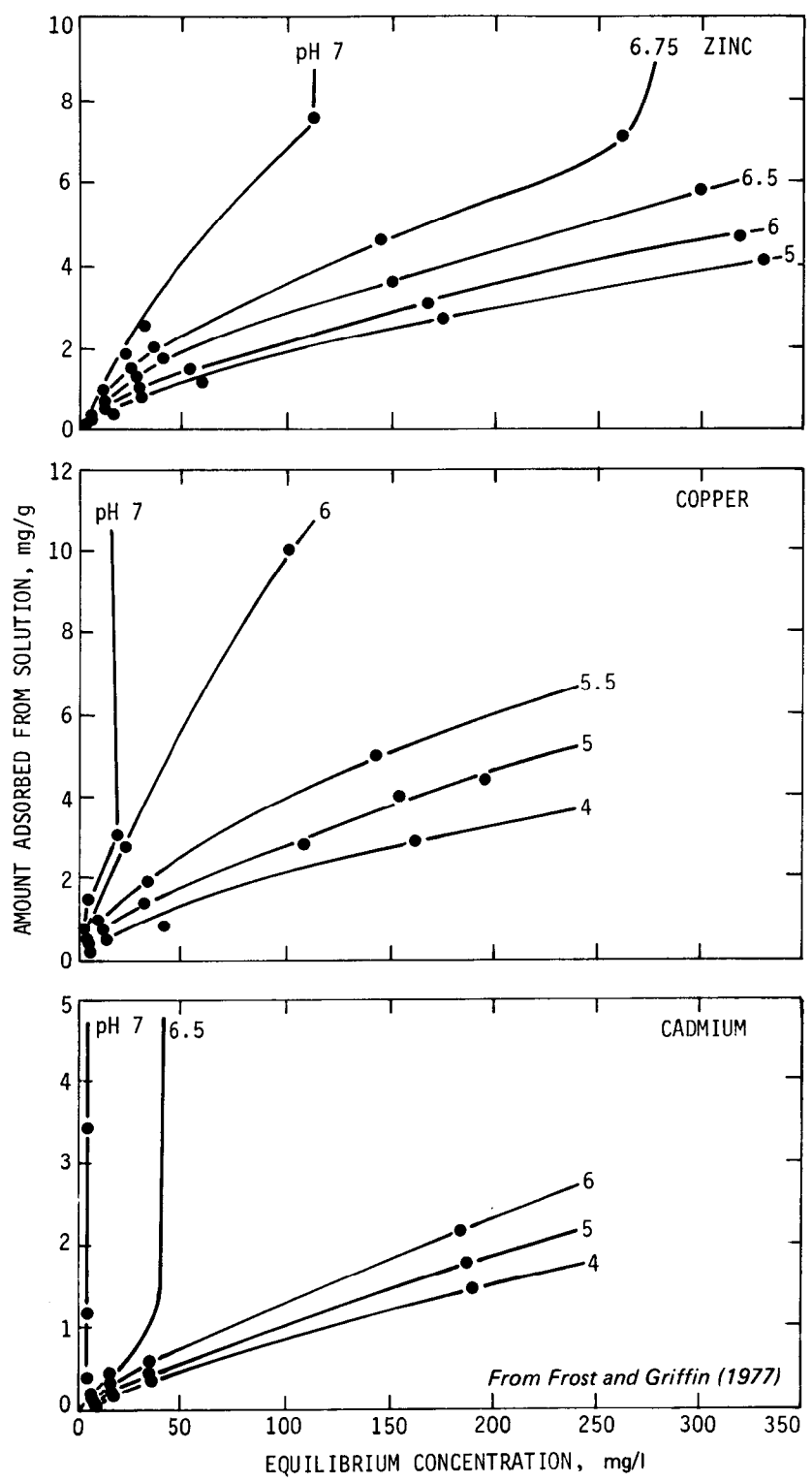

Figure 20. Representative adsorption isotherms for zinc, copper, and cadmium at various pH values

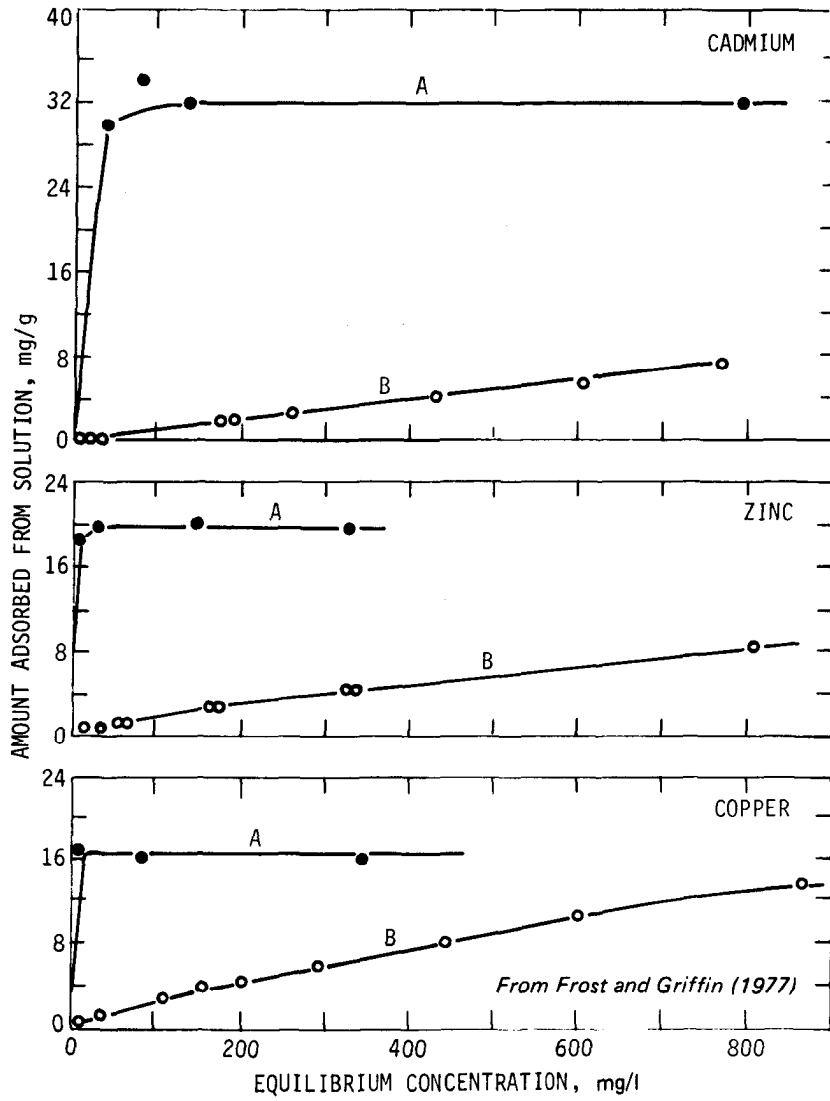

Figure 21. Montmorillonite adsorption isotherms for cadmium, zinc, and copper

The data at Site A indicate that the concentrations of zinc in the soil are highest in soils with a pH less than 6.5. Soil pH values as low as 3.4 were recorded and increased with depth to normal values around 7 to 8. Therefore, at low pH values, adsorption or cation exchange is the mechanism of heavy metal attenuation. The metals are adsorbed by the clays from solution as the liquid moves through the subsurface. As the pH increases, heavy metals not adsorbed by cation exchange are precipitated, thereby reducing concentrations of heavy metals in solution. Thus, pH controls the maximum concentration possible in solutions.

Zinc concentrations in water samples collected from wells at Site A are presented in Table 6. All wells finished at the bedrock surface (1D through 9D) produced water containing less than 0.5 mg/l Zn. The few isolated samples indicating higher zinc contents were determined not to be representative.

The zinc content of water collected from the shallow wells tapping the Hagarstown sand unit is shown in Figure 22. Figure 22b, illustrating data for samples collected August 13, 1975, represents the minimum extent of shallow groundwater contamination, and Figure 22a, illustrating data for samples collected September 9, 1976, represents the maximum extent of contamination. Because the sampling procedure was not satisfactory and the attempt to detect well seal failures was unsuccessful, further analysis of the water quality data generated probably is not worthwhile. The sampling procedure used in this study would account for as much as 45 to 80 percent of the fluctuations noted between sampling periods.

To better define the quality of water in an affected and unaffected area, water samples were collected from wells 3S and 6S for total mineral analysis. The results of these analyses and the analysis of a water sample from the shallow control hole well indicate general agreement for 6S (the unaffected area well) and Control Hole 1S. Increases in mineral constituents in the affected area well (3S) are obvious (see Table 7).

Data from well 3S were as expected and substantiate the solubility product calculations. The zinc concentration (750 mg/l) and pH (6.5) are in excellent agreement with the solubility of zinc hydroxide (800 gm/l at 6.5 pH).

These conclusions are borne out by the data from the soil cores as well as the water quality data. For example, the zinc concentration in piezometer 535 is 750 mg/l, approximately the solubility of zinc hydroxide calculated at pH 6.5.

Evidence of ion exchange also is shown by the high concentrations of calcium (2400 mg/l) and magnesium (893 mg/l) present in this sample (3S). The cation exchange positions in soils in this region of Illinois are principally filled with calcium and lesser amounts of magnesium. Grim (1953) indicates that zinc is higher in the montmorillonite exchange series than calcium and magnesium, and thus will replace these ions on the clay structure. According to Griffin et al. (1976), this process releases calcium and magnesium to the environment even when these are not part of the original waste stream.

**Table 6. Zinc Concentrations in Water Samples from Wells at Site A
(Concentrations in milligrams per liter)**

	1975						1976					
	3-20	5-1	6-18	7-22	8-13	9-24	3-2	4-8	6-8	7-13	7-29	9-9
1S	18.	15.		1.3	1.8							
1D	0.58	0.51		*			*					
2S	4.3	1.4		7.6	*		*	2.	*	11.	*	5.7
2D	0.016	0.15		*								
3S	790.	660.	736.	628.	662.		662.	720.	602.3	240.	476.	300.
3D	0.017	0.72	*	25.8			.98	*				*
4S			8.4	*	*		*	*	1.4		10.3	*
4D			3.7	*	*		*	*				*
5S			*	*	*		*	*	*	*	*	3.7
5D				*	*		*	*	*	*	*	*
6S			*	*	*		*	*	*	*	*	*
6D			*	*	*		*	*	*	*	*	*
7S				*	*	*	*	*	*	*	*	*
7D				*	*	*	*	*	*	*	*	*
8S					*	*	*	*	*	*	*	*
8D					*	*	*	*	*	*	*	*
9S					*	*	*	*	*	*	*	*
9D			*		*	*		*				*
10S			207.	293.	350.		50.3	363.			447.	196.
10D				*	*		*	*	1.74	42.	224.	9.4
11									*	*	*	*
12			14,780	12,700	15,700		4000	12,476	15,300	15,600	21,580	15,600
13			6.2	10.9	16.9		33.8	500.	*	*	*	156.
14S			*	*	*		*	*	3.2	*	*	4.2
14D			*	*	*		*	*	*	*	*	4.8
15S			*	20.5	*		*	10.6	2.0	50.	198.	18.
15D			162.	144.	143.		12.9	*	*	110.	212.	87.
16			*	*	*		*	*	*	*	*	*
17			*	*	*		*	*	*	*	*	*
18			571.	566.	610.		353.7	585.	850.	170.	758.	342.
19				*	*	135.	.88	8.2	*	*	7.2	9.6
20				*	*	8.7	*	*	*	*	*	*
21				*	*	*	*	*	*	5.6	12.	*
22				*	*	*	*	*	*	*	*	*
23						308.	11.2	56.2	10.1	43.	103.	105.
24						*	*	*	*	*	*	*
25						*	*	*	*	*	*	*
26						*	*	*	*	*	*	*
27						4.9	*	*	*	*	13.1	*
28						*	*	*	*	*	*	*
29						*	*	*	*	*	*	*
30						*	*	*	*	*	*	*
31						*	*	*	*	*	*	*
32						*	*	*	*	*	*	*
33						*	*	*	*	*	*	*
36										*	*	*
37										*	*	*
CH 1S							*	*	3.1	*	*	*
CH 1D							*	*				*

S = shallow; D = deep; CH = control bore
 * = Values less than 0.5 mg/l

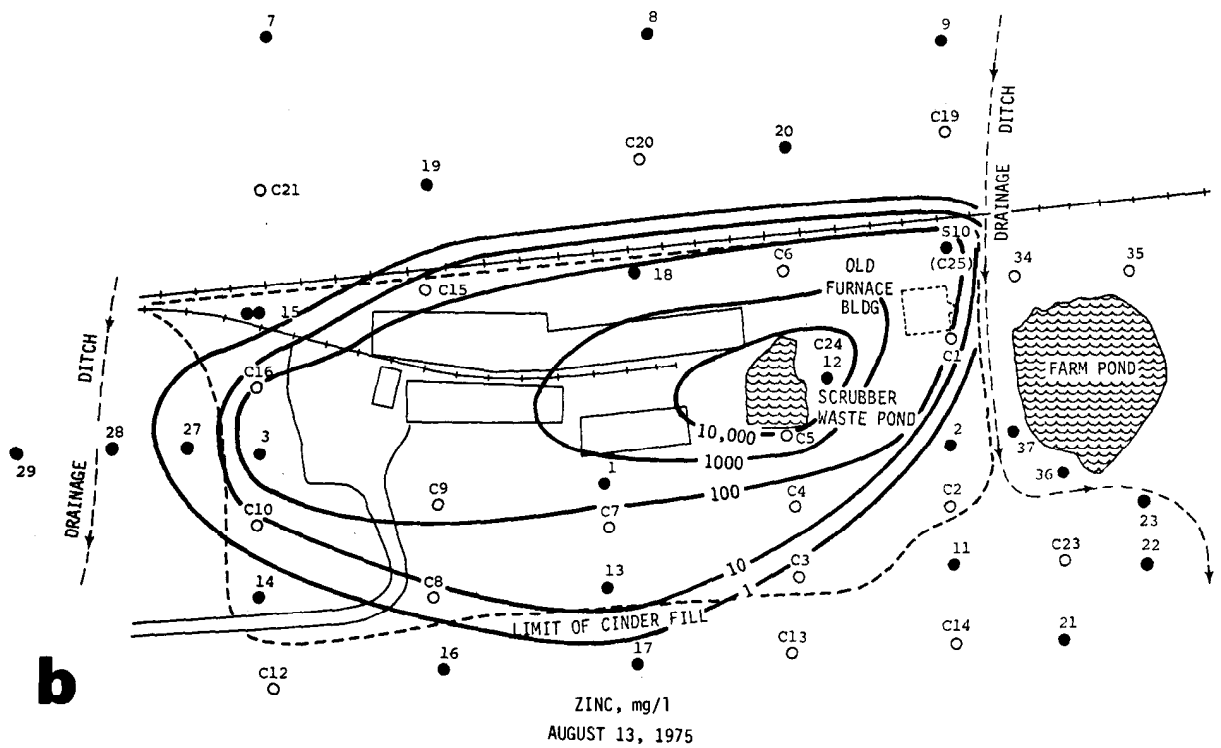
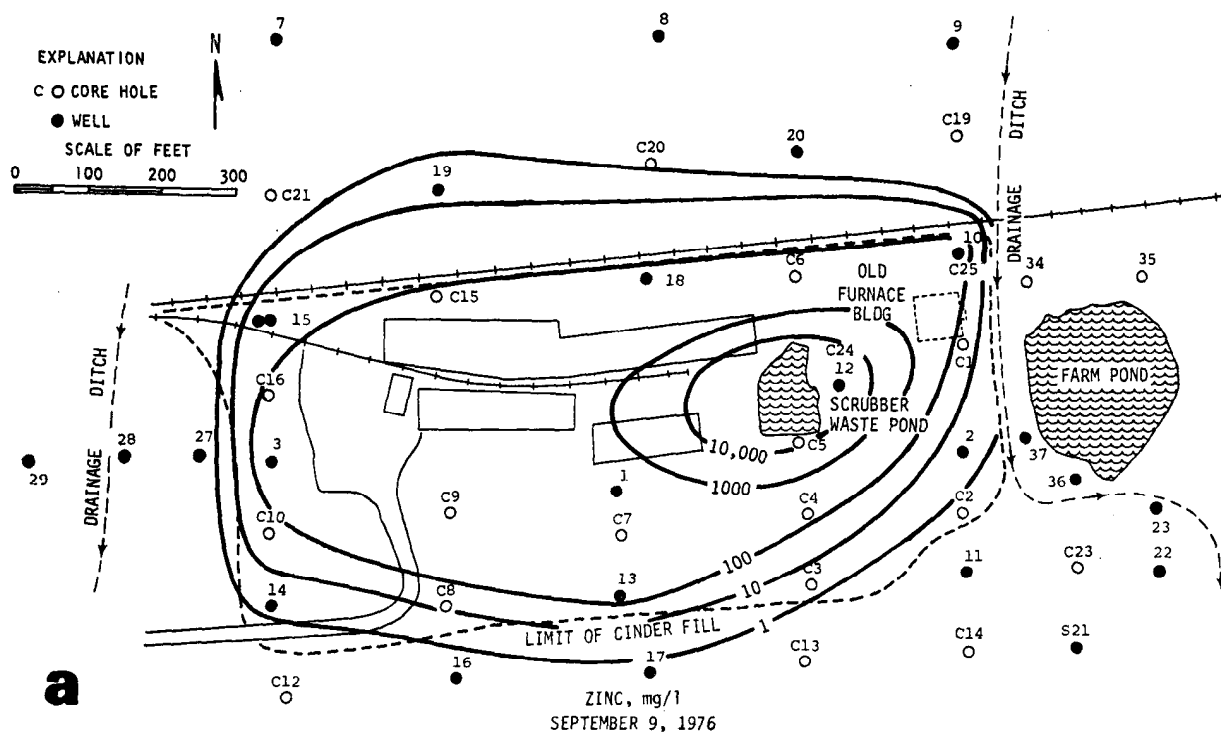

Figure 22. Zinc content of water from shallow wells — Site A

Table 7. Selected Total Mineral Analyses Data — Site A

	Control Hole 1S		6S		3S	
	mg/l	me/l	mg/l	me/l	mg/l	me/l
Fe	2.3		4.7		0.0	
Mn	0.14		44		21.01	
Ca	96.4	4.81	33.5	1.67	2,400	119.76
Mg	38.3	3.15	13.7	1.13	893.	73.44
Sr	0.27	0.01	0.08		5.25	0.12
Na	75.4	3.28	81.9	3.56	389.	16.92
K	1.0	0.03	0.6	.02	367.	9.39
NH ₄	0.1	0.01	0.0	.00	156.	8.64
Ba	**		**		**	
Cd	0.00		0.00		1.19	0.02
Cr	0.00		0.00		0.01	
Cu	0.00		0.00		0.04	
Pb	*		*		*	
Li	0.01		0.00		0.15	
Ni	*		*		2.8	0.10
Zn	0.00		0.04		750.	22.95
PO ₄ (filt)	0.1		0.1		0.0	
PO ₄ (unfilt)	0.5		0.4		0.0	
SiO ₂	15.8		13.2		33.1	
F	0.3		0.3		0.0	
B	0.0		0.1		0.5	
NO ₃	0.5	.01	1.2	.02	223.	3.59
Cl	6.	.17	20.	.56	8,300	234.06
SO ₄	140.1	2.91	120.1	2.50	564.0	11.73
Alk. (as CaCO ₃)	404.	8.08	166.	3.32	40.	0.80
Hard. (as CaCO ₃)	398.	7.96	140.	2.80	9,660	193.20
TDM	615.		394.		13,802	

* = values less than 0.05 mg/l

** = values less than 0.1 mg/l

Because of these phenomena, it is recommended that total mineral analyses be conducted on water samples from monitoring wells where cation exchange is likely to occur. An increase in one or more of these constituents (calcium or magnesium) could be an early warning of the eventual appearance of the more toxic metals.

In addition to the groundwater study at this site, Dr. William R. Edwards of the Illinois State Natural History Survey conducted a preliminary study of the surface soils and vegetation species surrounding the site. The findings of his work are summarized in the following paragraph.

Levels of zinc in surface soils were high near the smelter at site A and tended to decrease with distance from the smelter. Statistical modeling indicated that zinc is significantly conserved in soil organic matter. Consistently high levels of zinc were detected in alluvial outwash soils high in organic matter for considerable distances below the smelter. The conclusion was drawn that erosion of surface soils high in zinc serves as a transport mechanism in the dispersion of zinc away from the smelter. The distribution, density, and productivity of wild plants and the planting of agricultural crops in the vicinity of the smelter were significantly

related to the zinc content of surface soils. Chemical analyses of plants indicated: a) that the zinc status of plants reflects, at least in part, the zinc status of their environments; b) that different plants, even those growing in close association, evidence quite different levels of zinc; and c) that different parts of plants concentrate zinc at different rates. Although statistical analyses have not been completed, all observations that bear on findings of previously reported research on zinc plant relationships are in general agreement with the earlier findings. The hypothesis is advanced that amino acids may be involved in the transport and accumulation of zinc in plants, and are related to the concentration of zinc in the soil solution and soil organic matter.

The soil coring and sampling of wells at Site A defined the migration patterns of toxic metals from this site into the ground and shallow groundwater system. Cation exchange and precipitation of metal compounds as a result of the change in pH of the infiltrating fluid are the principal attenuating mechanisms influencing the metals movement. The geologic setting has the ability to contain high concentrations of toxic metals over an extended length of time.

Site B

Site B also is a secondary zinc smelter located in south-central Illinois. As at Site A, this was a primary smelting operation processing zinc ore from about 1904 until 1962. It was then converted to a secondary smelting operation and currently is reprocessing selected scrap metals. Wastes from this smelter during the early years of operation were the same type of metals-rich ashes and cinders as at Site A. An area of approximately 38 acres at the plant site is covered with from 1 to 15 feet of these metals-rich cinders.

In compliance with air pollution regulations, this industry installed an electric precipitator on its stacks in 1968. The precipitated particles are immediately recycled into the smelting process.

The suspected sources for groundwater contamination at this site were essentially the cinder fill material and stored scrap or junk on the plant property. Since this site is so similar to Site A, a minimum amount of time and effort were spent in studying it. A basic grid of 9 locations (22 wells) was established to form a basis for study (Figure 23). An additional six wells eventually were constructed to permit more detailed metals migration definition. Total well and coring footages are about 1010 and 785 feet, respectively.

Geology

The glacial drift at this site ranges in thickness from 40 to 65 feet, becoming thicker where the drift fills a northwest-southeast trending bedrock valley (Figure 24a and b). The elevation of the Pennsylvanian bedrock ranges from greater than 410 feet above sea level in the southwest and northeast portions of the site to less than 390 feet in the valley to the northwest. The stratigraphic units are continuous across the site and

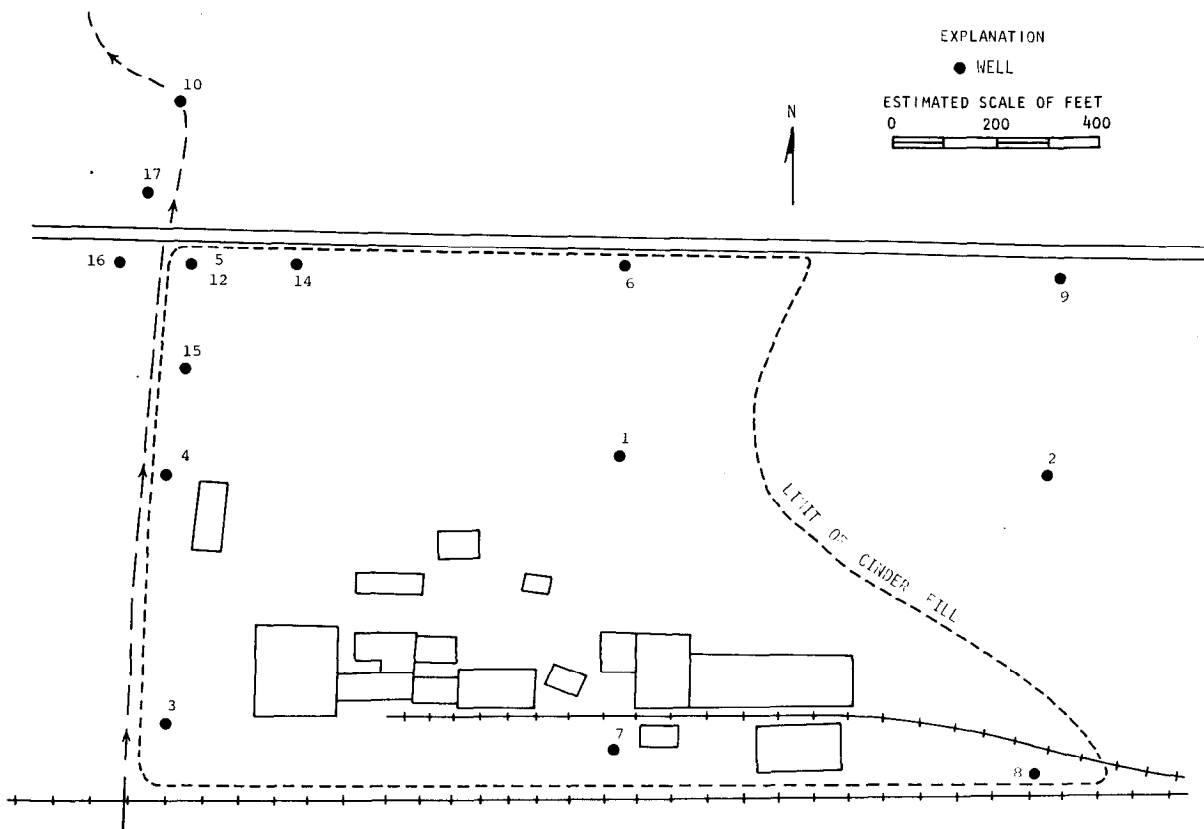

Figure 23. Location map — Site B

tend to drape over the bedrock surface, gently dipping toward the valley (Figures 25 and 26). Data from selected borings are included in the Appendix. Table 8 summarizes the textural and mineralogical information for each unit. A brief description of each stratigraphic unit follows.

Wisconsinan Stage

- A) Peoria Loess (0 to 5 feet thick) - Massive, brown, clayey silt. Sand content is low. Expandable clay minerals make up over 80 percent of the clay fraction. Modern Soil developed in the Peoria; organic material and iron stains are common. This unit is leached.
- B) Roxana Silt (3 to 8 feet thick) - Brownish-gray sandy silt. Sand content increased from about 18 percent at the top to about 28 percent at the base. Clay mineralogy similar to the overlying Peoria. The buried Farmdale Soil has developed in the Roxana, which is leached and contains some organic material and abundant iron stains.

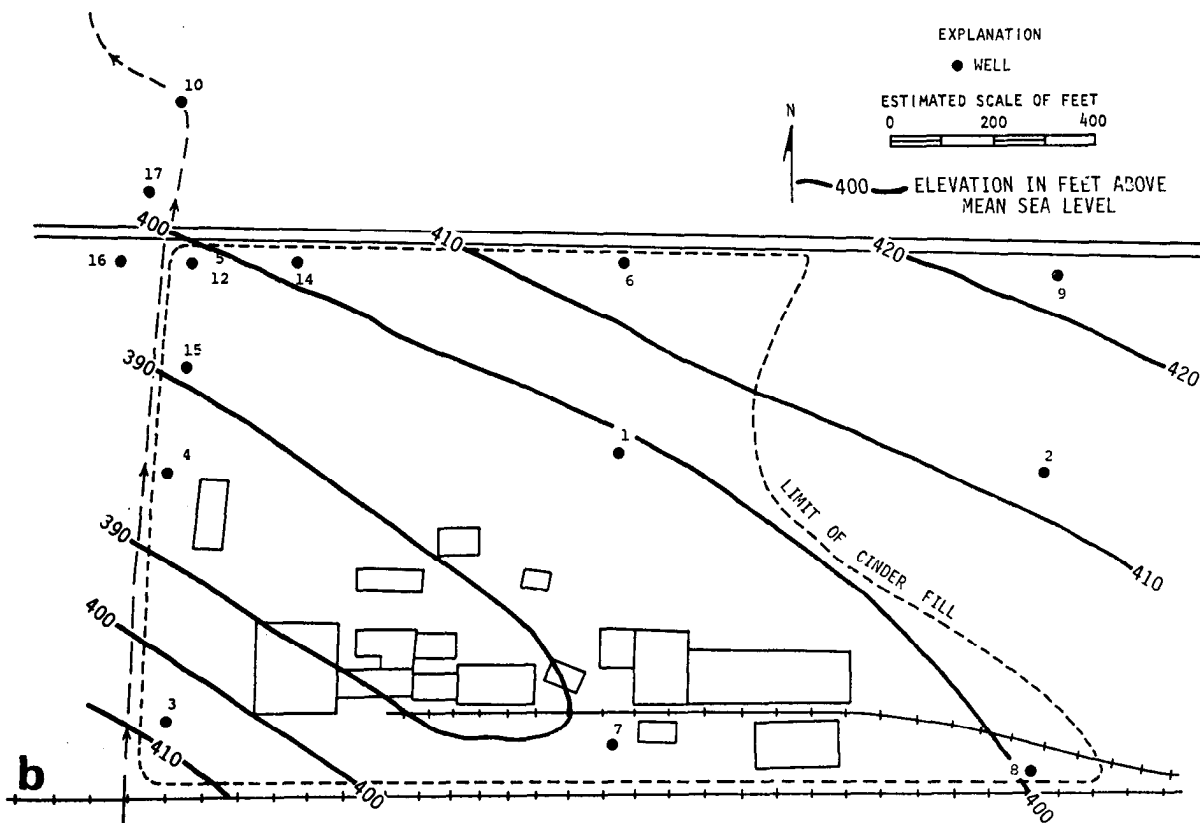
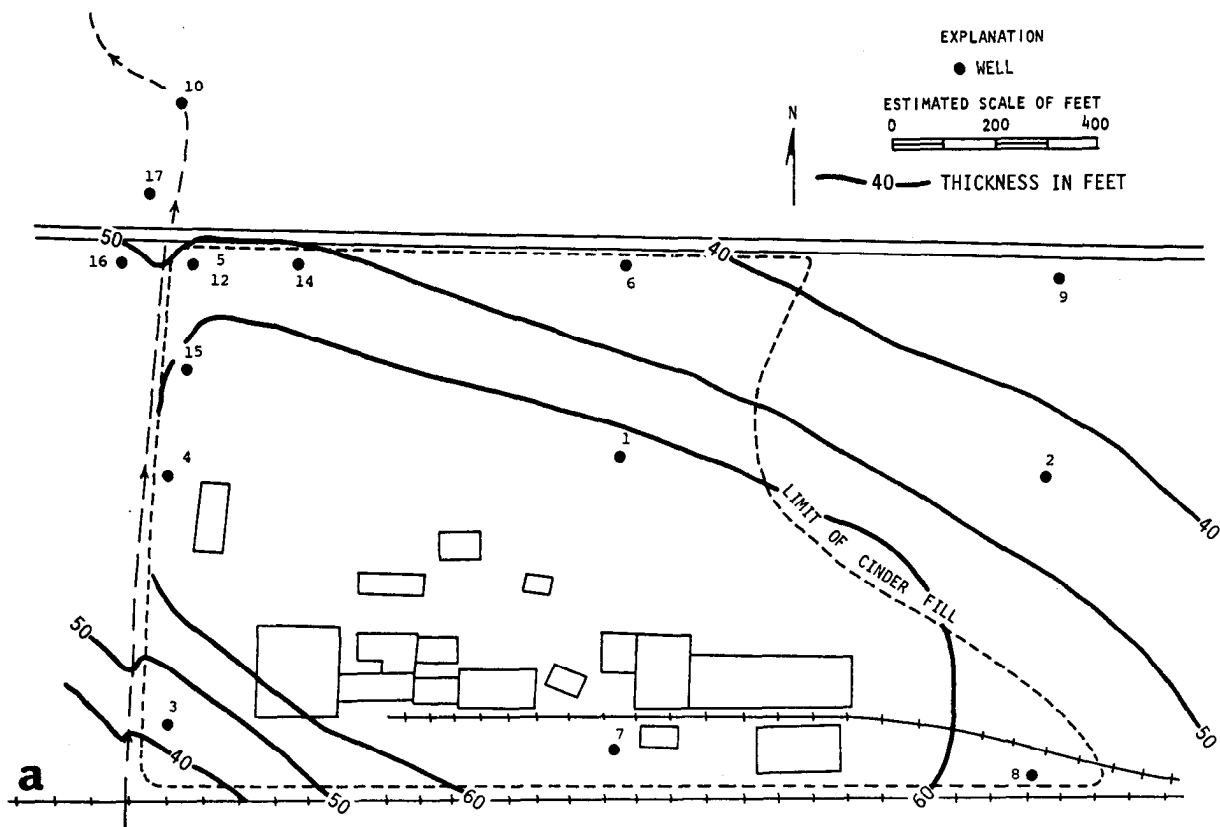

Figure 24. Generalized maps for a) drift thickness and b) bedrock surface — Site B

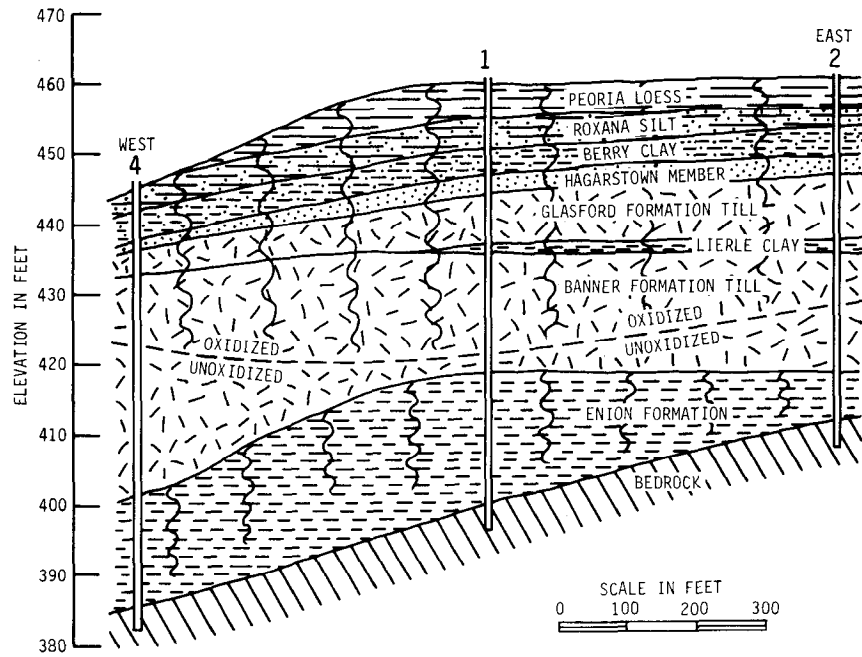

Figure 25. West-east stratigraphic cross section — Site B

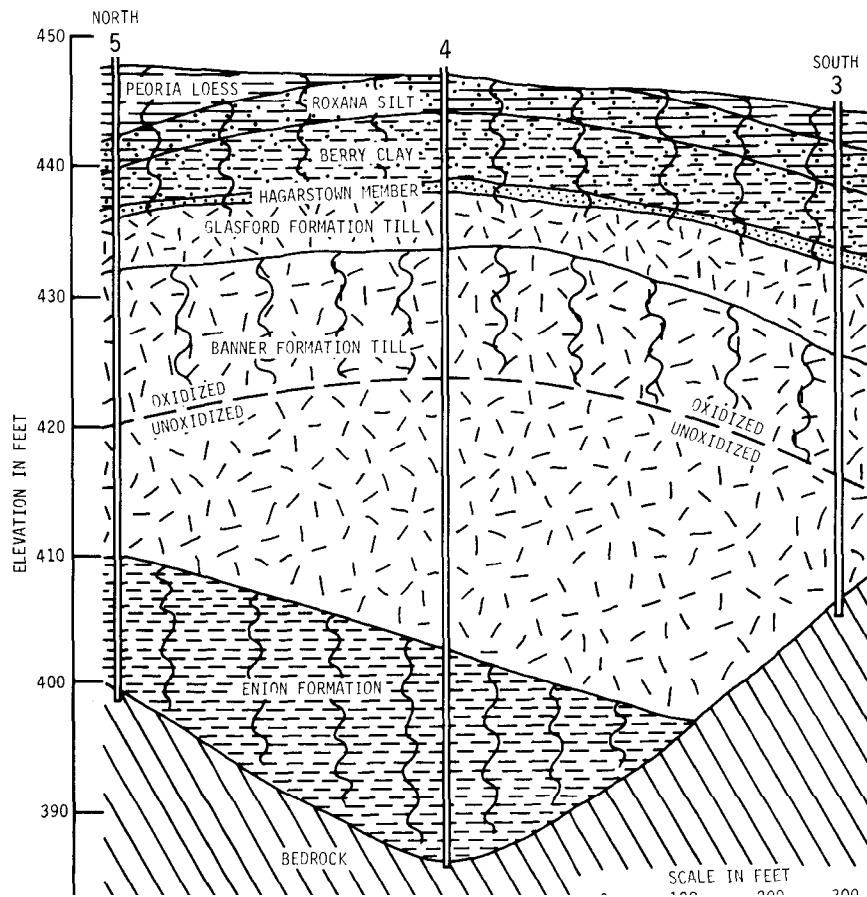

Figure 26. North-south stratigraphic cross section — Site B

Table 8. Textural and Mineralogical Data for Stratigraphic Units — Site 8

STAGE	UNIT	AVERAGE TEXTURE	AVERAGE CLAY MINERALOGY (<2μ)	CARBONATE MINERALOGY (<2μ)
WISCONSINAN	PEORIA LOESS	(5-63-32) 28 samples	M 64% I 24.5% 8 samples	LEACHED
	ROXANA SILT	(16-57-27) 20 samples	M 80% I 12% 9 samples	LEACHED
SANGAMONIAN	BERRY CLAY MEMBER-GLASFORD FORMATION	(33-35-32) VARIABLE 19 samples	M 85% I 10% VARIABLE 19 samples	LEACHED
ILLINOIAN	HAGARSTOWN MEMBER-GLASFORD FORMATION	(41.5-29.5-29) VARIABLE 12 samples	M 72% I 18% 9 samples	LEACHED
	GLASFORD FORMATION TILL	(39-38-23) 35 samples	M 35% I 46% 39 samples	CONTAINS CARBONATES MAY BE LEACHED AT TOP
YARMOUTHIAN	LIERLY CLAY MEMBER-BANNER FORMATION	(21-37-42) 3 samples	M 58% I 24% 3 samples	LEACHED
KANSAN	BANNER FORMATION TILL	(29-42-29) Oxidized: (30-41-28) Unoxidized: (28-43-29) 115 samples	M 19% I 56% M (Ox.) 22% I (Ox.) 59% (Unox.) 15% I (Unox.) 52% 102 samples	CONTAINS CARBONATES MAY BE LEACHED ATTOP
NEBRASKAN (?)	ENION FORMATION	(7-54-39) 51 samples	M 45% I 26.5% VARIABLE 45 samples	LEACHED
PENNSYLVANIAN SYSTEM	MODESTO FORMATION	(2.5-48-49.5) 14 samples	M 11% I 61% 10 samples	LEACHED

Note: (5-63-32), etc. = Average percentage of sand, silt, and clay excluding gravel

M 64%, etc. = Average percentage of montmorillonitic (expandable) minerals in clay fraction (<2μ)

I 24.5%, etc. = Average percentage of illite in clay fraction

Sangamonian Stage

Glasford Formation

- C) Berry Clay Member (3 to 5 feet thick) - Brownish-gray and yellow-brown mottled sandy silty clay with some gravel. Sandier than the Roxana and may contain up to 50 percent sand. Clay mineralogy is similar to both the Peoria and Roxana. Considered an accretion-gley deposit. The buried Sangamon Soil is developed in the Berry; it is leached, iron stained, mottled, and contains some organic material.

Illinoian Stage

- D) Hagarstown Member (1 to 3 feet thick) - Thin, yellowish-brown silty sand to sandy till. Appears uniform in each boring but is variable in character from one boring to another, much more so than at Site A. In some borings, it is difficult to distinguish from the underlying Glasford Formation Till.

Sand content varies from hole to hole, but is typically over 30 percent and is similar to the underlying till. The percentage of expandable clay minerals is much higher than at Site A, whereas illite content is lower. This unit is leached and iron stained, reflecting the development of the Sangamon soil. The lithologic variability of this unit indicates an ablation origin that is related to the deposition of the underlying till even though it is not mineralogically similar.

- E) Glasford Formation Till (0 to 10 feet thick) - Brownish-gray to sandy silt till. Sand content typically over 30 percent. Illite content much higher and expandable clay content much lower than the overlying units. As at Site A, carbonates are present although the top of the till may be leached. Included in the till are sand lenses and sand coatings in joints. The till is thinner and more uniform in character than at Site A, and may represent only one glacial episode.

Yarmouthian Stage

Banner Formation

- F) Lierle Clay Member (0 to 3 feet thick) - Thin, discontinuous brown to green sandy silty clay with a trace of gravel. X-ray data show the Lierle to contain a high percentage of expandables and a relatively low percentage of illite. It is leached and the Yarmouth Soil is developed in this unit; an accretion-gley.

Kansan Stage

- G) Banner Formation Till (13 to 32 feet thick) - Oxidized brown sandy silt till over a lower, unoxidized, gray-brown clayey silt till. The entire till unit contains carbonates but the upper portion has been oxidized by the development of the Yarmouth Soil. Illite content is high and expandable clay content is low throughout the till unit (see Table 8). Texturally and mineralogically the till is fairly homogeneous, although the oxidized till is slightly sandier with a greater proportion of expandables and illite than the unoxidized till (see Table 8). Composition of the till appears to relate to the material it rests on in each boring, suggesting local incorporation. Till thickness ranges from 13 to 23 feet. The upper, oxidized zone is 7 to 18 feet thick, while the lower, unoxidized portion varies in thickness from 0 to 22 feet.

Nebraskan Stage

- H) Enion Formation (0 to 22 feet thick) - Dark olive-brown to brown and gray silts and clays of varying thickness. The thickness of this deposit appears to be related to the bedrock valley beneath the site (Figure 27). Sand content is generally less than 10 percent. Expandable clay minerals are typically more abundant than illite, but the mineralogy varies from hole to hole. The sequence is leached with localized mottling and iron stains at the top of the unit reflecting soil formation.

This interval appears to represent post-Pennsylvanian, pre-Kansan quiet-water sedimentation. The absence of carbonates suggests a long period of soil formation prior to invasion of Kansan glaciers. The unit is therefore assigned to the Enion Formation of Nebraskan age.

Pennsylvanian system

- I) Modesto Formation -Bedrock consisting of greenish - gray shale with abundant mica. Data are limited because drilling was usually terminated at the top of bedrock.

Available information suggests little montmorillonite and abundant illite (Table 8). The shale is leached and fine-grained, with very little sand.

Five soil profiles were identified in the glacial record at Site B. In addition to the four soils found at Site A - Yarmouth, Sangamon, Farmdale, and Modern - the Afton Soil is developed in the Enion Formation.

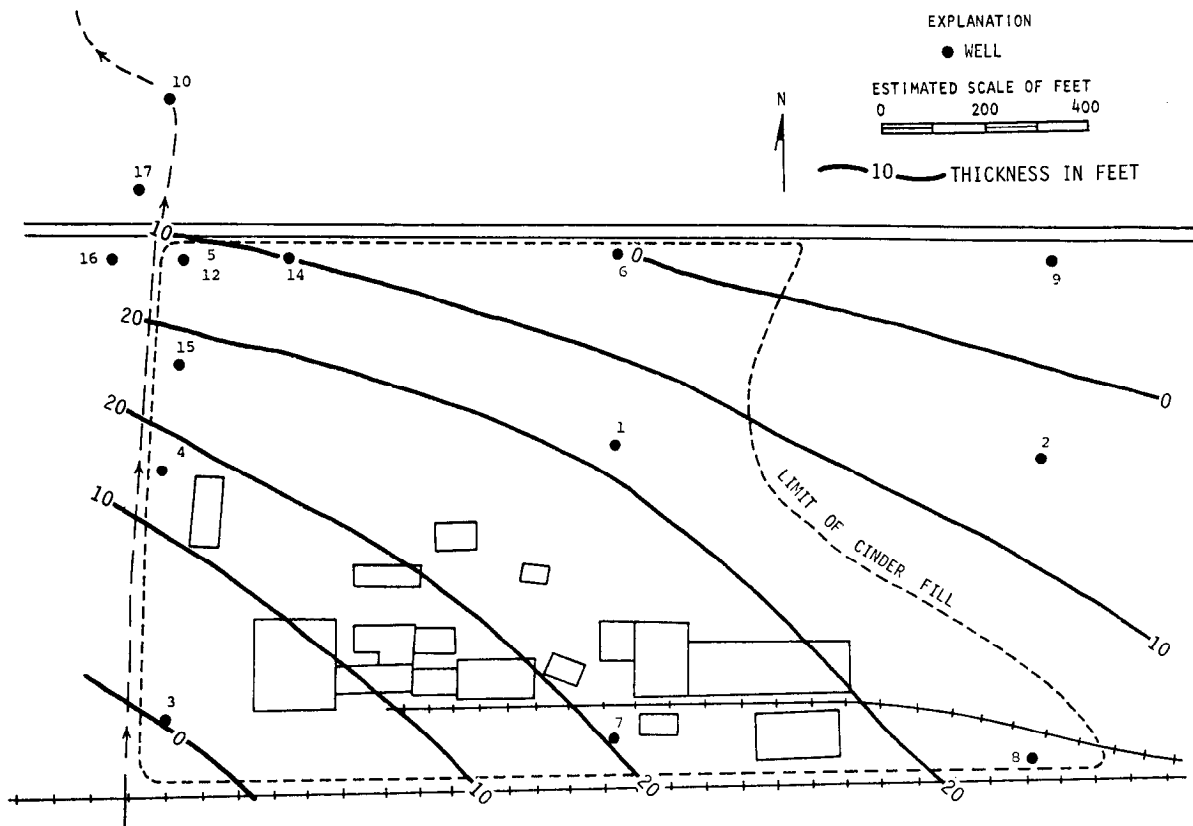

Figure 27. Thickness of Enion Formation — Site B

Inasmuch as the upper four units are thin and contain three soil profiles, the glacial drift is leached from the surface to a depth of 10 to 22 feet. The zone of leaching typically extends into the Hagarstown or Glasford Formation Till.

Hydrology

On the basis of the geologic description of Site B, the only aquifer of significance at this site is the Hagarstown Member, a 1- to 3-foot-thick sand unit. This unit occurs at depths from 6 to 10 feet and offers the only significant permeable zone that could allow for lateral groundwater movement away from the site.

Because of the similarity of geologic units at Sites A and B, no pumping test was conducted at Site B. The coefficient of transmissivity of the sand unit was assumed to be the same as at Site A, 285 gpd/ft. This results in an average hydraulic conductivity of about 145 gpd/ft.

Water level hydrographs for all shallow wells at Site B are presented in Figure 28. Also included is a graph of precipitation for the period of record. The hydrographs for wells 1S, 2S, 6S, 7S, 8S, 9S, and the two

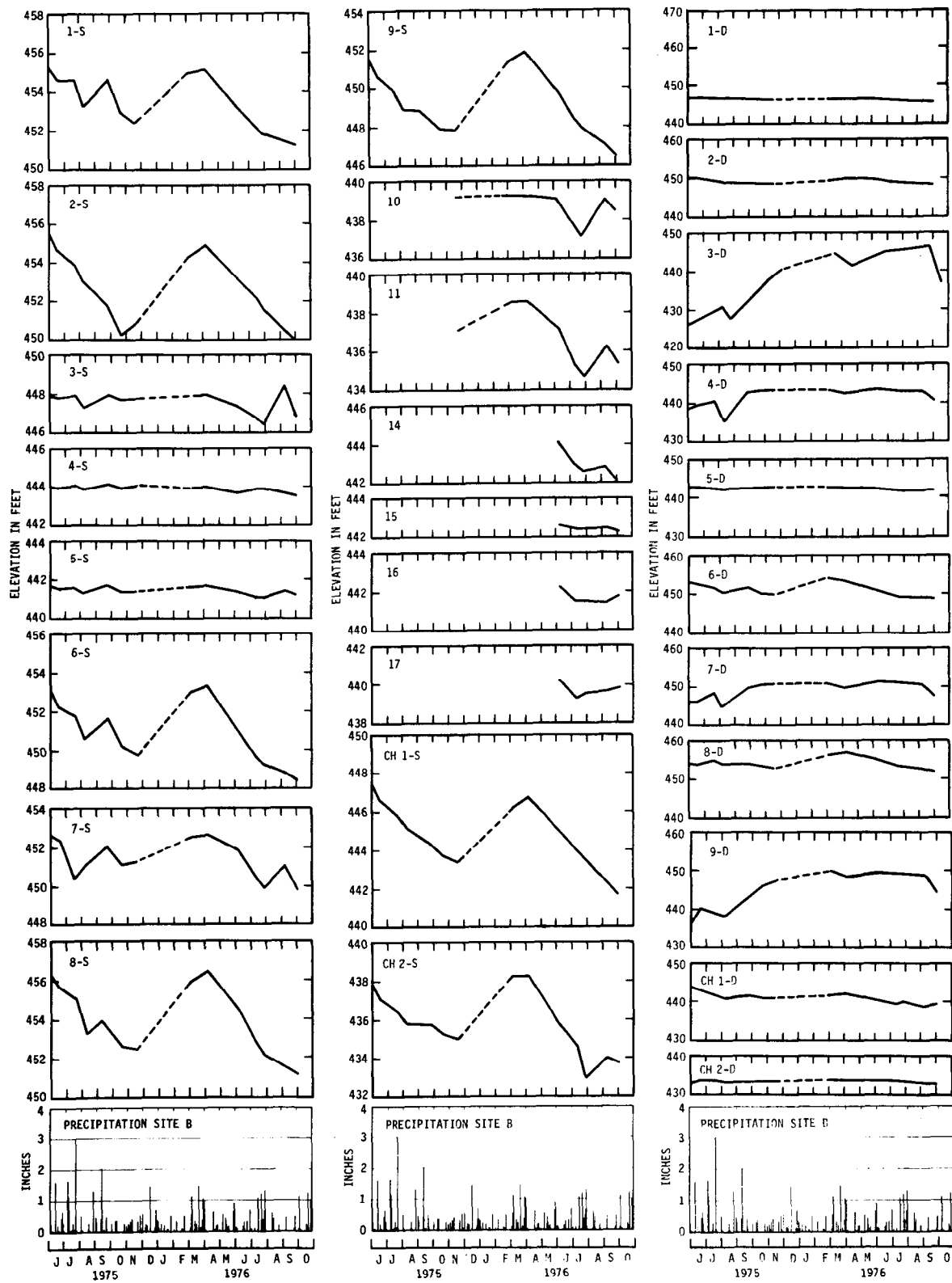

Figure 28. Water level hydrographs for shallow and deep wells – Site B

control holes indicate that these upland wells are particularly responsive to precipitation. Wells 3S, 4S, and 5S located along the creek draining the plant site are in lowland settings and are therefore subject to less variation in water levels. Maximum and minimum water levels for the shallow wells are summarized in Table 9.

Piezometric surface maps were drawn for each round of water level measurements made. Figures 29a and b for March 1975 and October 1976, respectively, illustrate the high and low water level configurations. In both instances the principal direction of groundwater movement is to the west and then north. This coincides with the surface drainage patterns established by the land surface topography.

Water level hydrographs for all deep wells at Site B also are presented in Figure 28. There are two complicating factors that should be kept in mind when looking at the deep well water levels. The lack of stabilization of water levels with time was an apparent problem in wells 3D, 4D, 7D, and 9D. Wells 3D through 8D were constructed by the multi-well technique (placement of several wells of different depths in one bore hole) discussed earlier. Observations of water levels with time and the response of shallow water levels while pumping deep wells indicate that the seals between well screens in wells 6 and 8 were leaking. The water levels measured in the deep wells were therefore more representative of shallow water levels. Maximum and minimum water levels of the deep wells are summarized in Table 10.

An estimated piezometric surface map for the deep wells is presented in Figure 30. In general, water levels in the deep wells are lower than

Table 9. Range of Water Level Fluctuations in Shallow Wells — Site B

Well	Land surface elev (ft)	Low			High			Fluctuation (ft)
		Depth below land (ft)	Mean sea level (ft)	Date	Depth below land (ft)	Mean sea level (ft)	Date	
1S	457.36	6.16	451.20	10-1-76	0.99	356.37	3-19-75	5.17
2S	459.38	9.41	449.97	10-1-76	2.01	457.37	3-19-75	7.40
3S	449.93	3.49	446.44	7-30-76	1.56	448.37	9-9-76	1.93
4S	446.59	3.06	443.53	10-1-76	1.90	444.69	4-23-75	1.16
5S	447.55	6.50	441.05	7-30-76	5.44	442.11	3-19-75	1.06
6S	455.83	7.65	448.18	10-1-76	1.21	454.62	3-19-75	6.44
7S	455.54	5.70	449.84	10-1-76	2.12	453.42	3-19-75	3.58
8S	457.88	6.81	451.07	10-1-76	0.20	457.68	3-19-75	6.61
9S	455.67	9.15	446.52	10-1-76	2.91	452.76	5-1-75	6.24
10	440.27	3.08	437.19	7-30-76	0.98	439.29	3-2-76	2.10
11	438.79	4.10	434.69	7-30-76	0.13	438.66	4-6-76	3.97
14	452.07	9.95	442.12	10-1-76	9.16	442.91	7-13-76	0.79
15	448.42	6.16	442.26	10-1-76	5.79	442.63	6-8-76	0.37
16	446.30	4.78	441.52	7-30-76	3.86	442.44	9-9-76	0.92
17	444.77	5.35	439.42	7-13-76	4.44	440.33	6-8-76	0.91
CH 1S	452.00	10.34	441.66	10-1-76	3.26	448.74	4-23-76	7.08
CH 2S	445.00	12.09	432.91	7-30-76	6.36	438.64	5-1-76	5.73

S = shallow; CH = control hole

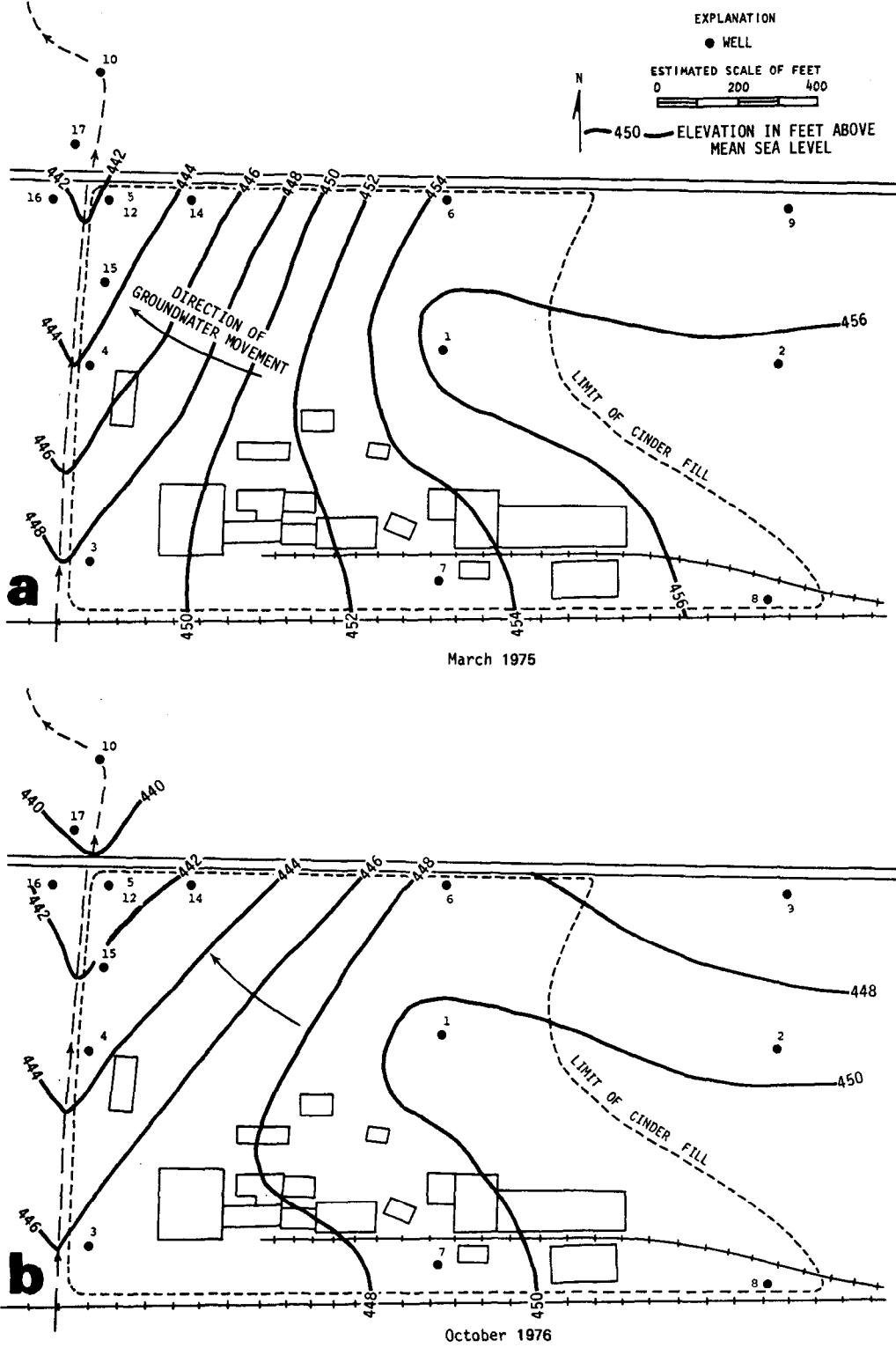

Figure 29. Piezometric surface maps for a) March 1975, and b) October 1976, for shallow wells at Site B

Table 10. Range of Water Level Fluctuations in Deep Wells — Site B

Well	Land surface elev (ft)	Low			High			Fluctuation (ft)
		Depth below land (ft)	Mean sea level (ft)	Date	Depth below land (ft)	Mean sea level (ft)	Date	
1D	457.36	11.70	445.66	10-1-76	10.31	447.05	5-20-75	1.39
2D	459.38	22.54	436.84	2-13-75	8.98	450.40	3-19-75	13.56*
3D	449.93	34.20	415.73	2-13-75	4.29	445.64	7-30-76	29.91*
4D	446.59	11.83	434.76	4-23-75	2.93	443.66	3-2-76	8.90
5D	447.55	6.06	441.49	7-29-75	4.79	442.76	3-19-75	1.27
6D	455.83	7.55	448.28	10-1-75	1.43	454.40	3-19-75	6.12**
7D	455.54	52.71	402.83	2-1 3-76	4.34	451.20	6-8-76	48.37*
8D	457.88	8.05	449.83	4-23-75	1.07	456.81	4-6-76	6.98**
9D	455.67	28.23	427.44	5-1-75	5.69	449.98	3-2-76	22.54*
CH 1D	452.00	12.65	439.35	10-1-76	6.14	445.86	5-1-75	6.51
CH 2D	445.00	14.19	430.81	4-23-75	11.25	433.75	3-2-76	2.94

*Water levels not stabilized
 ** Leakage between shallow and deep wells noted
 D = deep; CH = control hole

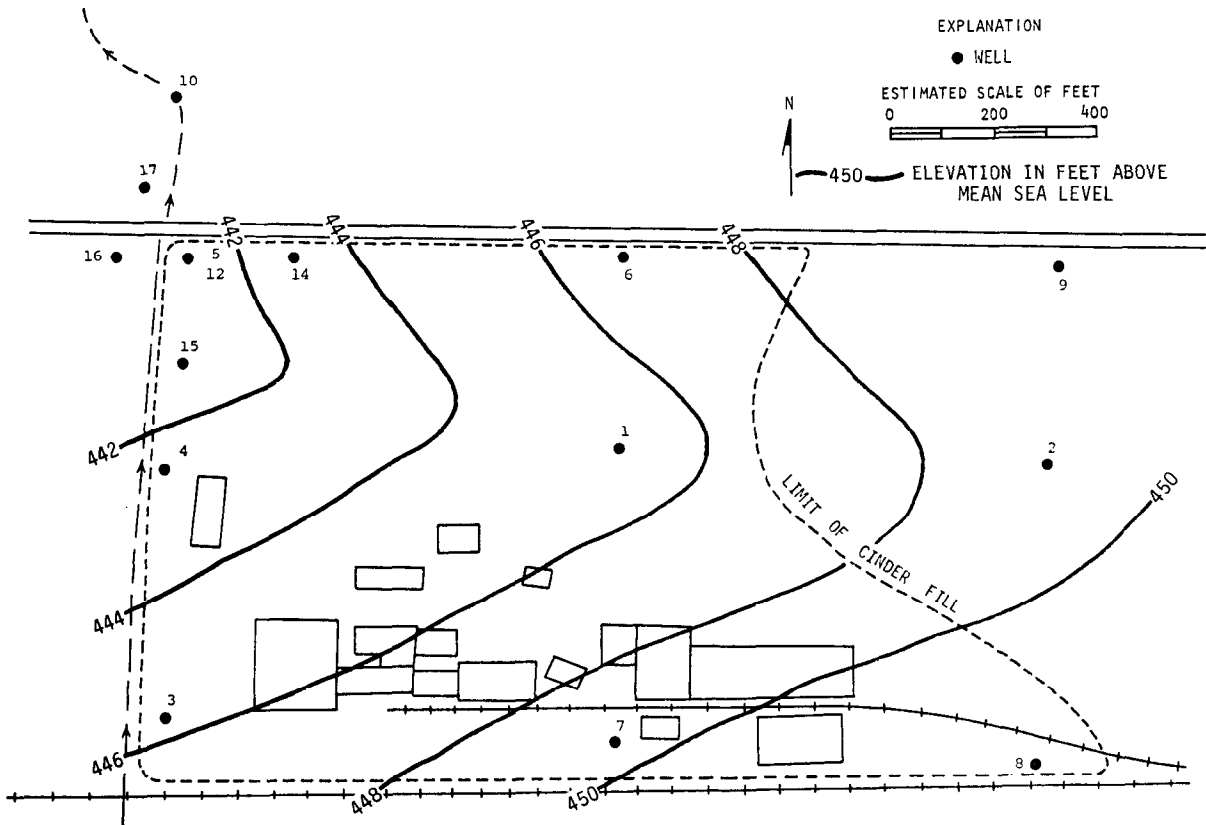

Figure 30. Estimated piezometric surface map for deep wells — Site B

those in the shallow wells, indicating a probable downward movement of water within the drift section.

Application of Darcy's equation to determine the rate of groundwater movement in the shallow deposits for October and March, using the same effective porosity or specific yield as at Site A, yields effective velocities of 1.0 to 2.0 ft/day or about 365 to 730 ft/year. These velocities are fairly high because of the steep hydraulic gradients present in the shallow drift materials.

A soil temperature survey at Site B was conducted by the Illinois State Geological Survey on July 11, 1975. The locations of the 50 stations used in this survey are shown in Figure 31. Temperature measurements could not be made in much of the western part of the area because of a thick cover of cinders on the land surface. Temperature measurements were made in degrees Fahrenheit at a depth of 2.3 feet below land surface. Lines of equal temperature on a contour interval of 2 degrees Fahrenheit are shown in Figure 31. High temperatures were measured in the vicinity of the

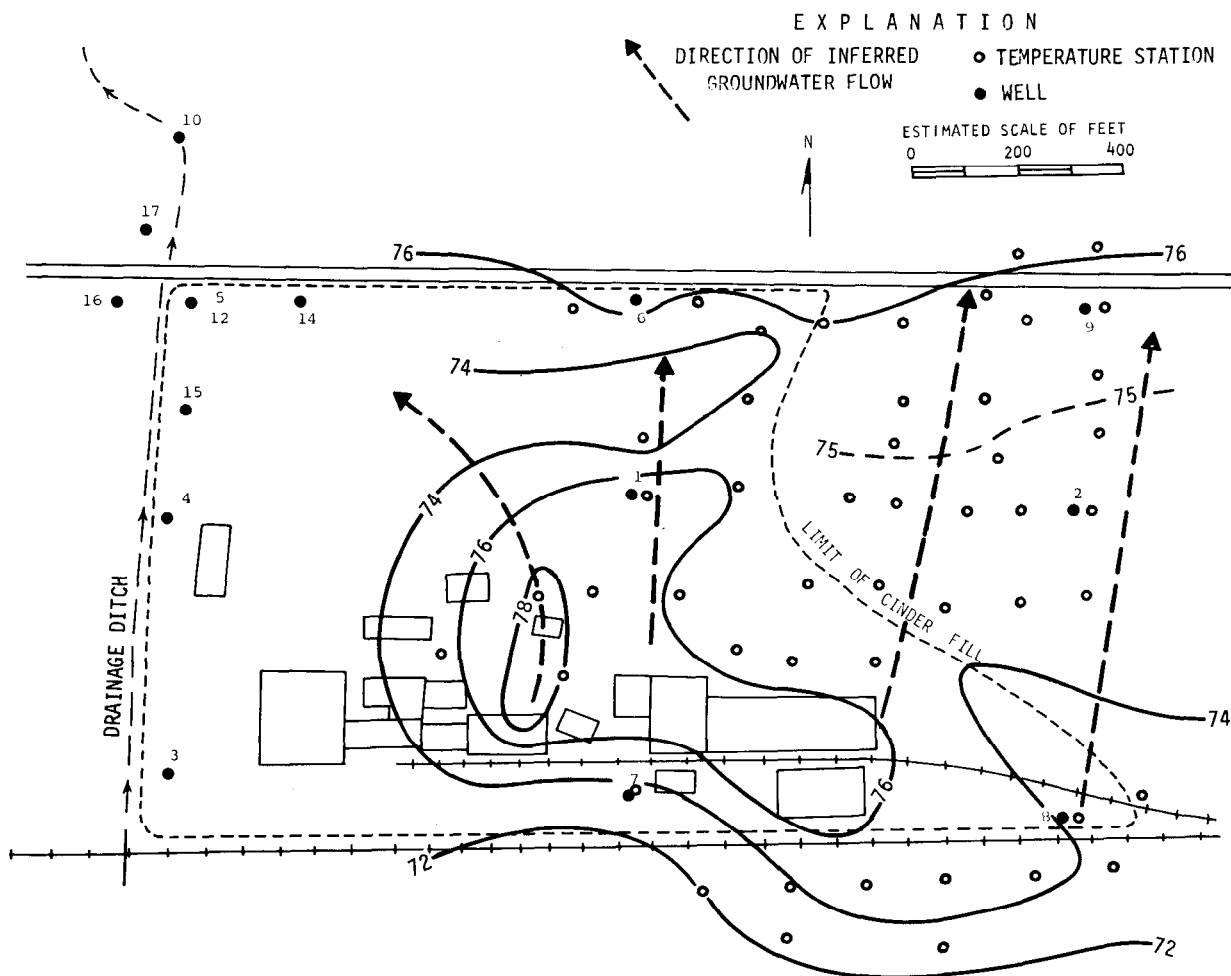

Figure 31. Soil temperature stations and results — Site B

buildings. On the basis of variations in soil temperatures across the area, the interpreted direction of groundwater flow is northward for the eastern part of the area and north to northwestward for the western part of the area. This compares favorably with the directions of groundwater flow determined from water level data (see Figure 29).

The ground in the eastern part of the area is covered by vegetation and solar heating effects appear to be uniform. The land surface in this area slopes to the north. The increase in soil temperatures from 72°F south of the railroad tracks to 76°F north of the highway is apparently caused by the transport of heat northward by groundwater flowing downslope in the shallow groundwater flow system.

Vegetation was generally absent in the western part of the site. Land surface cover in this area ranged from bare ground to various thicknesses of cinders and other refuse. The variation in the solar heating of this area makes soil temperature measurements unreliable for interpretation of shallow groundwater flow.

Chemical Data

Results of selected chemical analyses are given in the Appendix. On the basis of experience gained at Site A, zinc determinations were made for all holes, and multi-element analyses were run for only those holes where high zinc levels were detected (wells 5, 14, 15, 16, and 17).

Data from the two control holes located about 1-1/2 miles southwest of the site and unaffected parts of the cores at Site B indicate that background concentrations range from 20 to 50 mg/l for zinc, <0.02 to 0.20 mg/l for cadmium, 5 to 20 mg/l for copper, and 7 to 20 mg/l for lead. These values are closely comparable to those found at Site A. As at Site A, there was little variation in background levels with depth.

To outline the limits of migration of zinc beneath this site, a series of cross sections showing zinc concentrations in the soil were developed. Figures 32 and 33 illustrate the west-east and north-south cross sections, respectively. Penetration of zinc into the soil profile is limited to those areas overlain by cinder fill. The depth of penetration varies from near surface in the northeast portion of the plant property to a maximum of about 15 feet in the vicinity of well 5. In an effort to delineate the horizontal limits of zinc penetration around well 5, four core holes and wells were constructed surrounding it. From the results it appears very likely that well 5 is an anomaly. From conversation with the plant manager it was learned that well 5 is located at the site of an old entrance to the plant property. Over the course of the last 30 years, several types of disruptive construction activities have taken place in this area. The plant entrance road was closed and pilings were installed along the highway to support an extension of the fence along the north boundary of the plant site.

An east-west water main also was installed across the old roadway and, according to the plant manager, metals-rich cinders were used as fill and were introduced into the ground to a depth of about 10 feet.

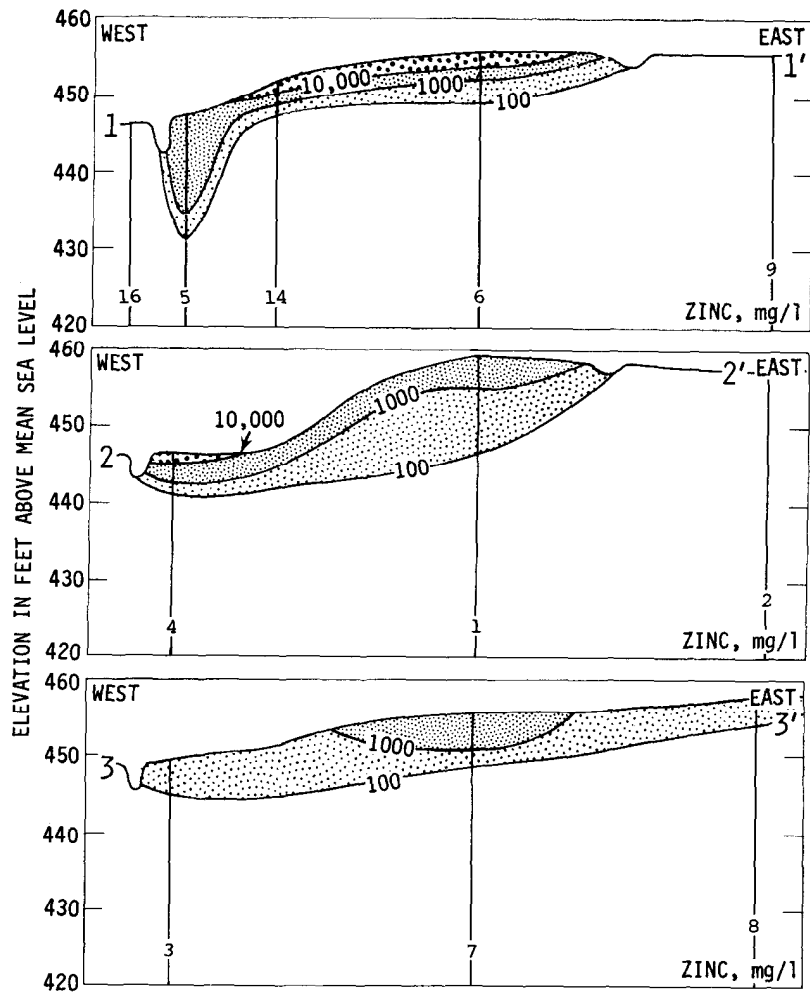
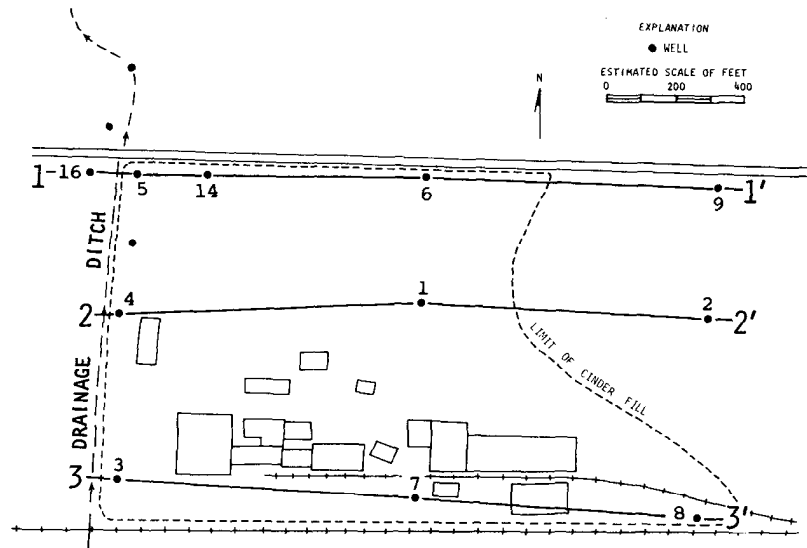

Figure 32. West-east profiles of zinc concentrations in soil — Site B

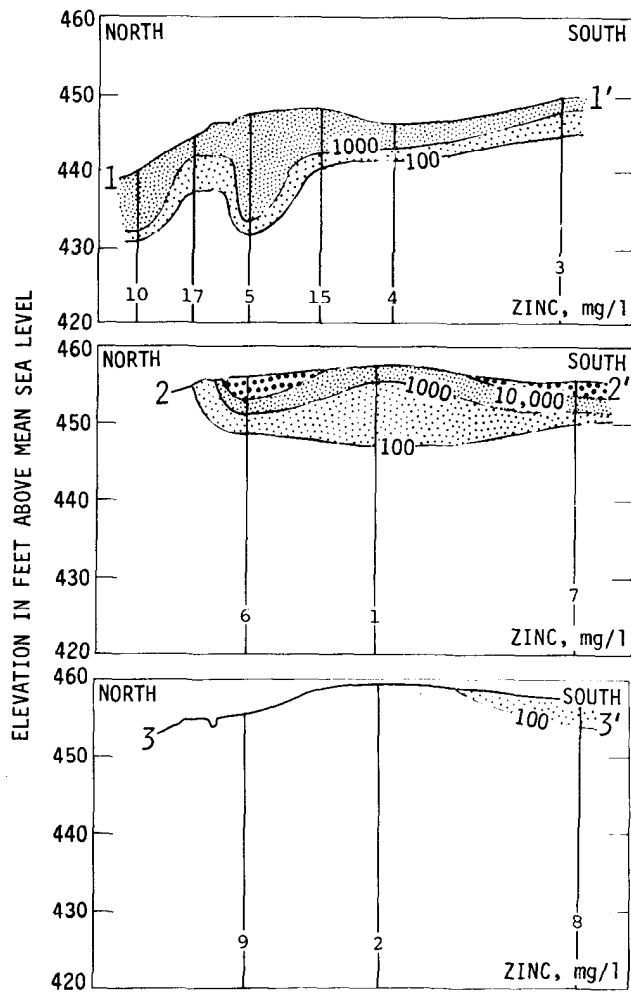
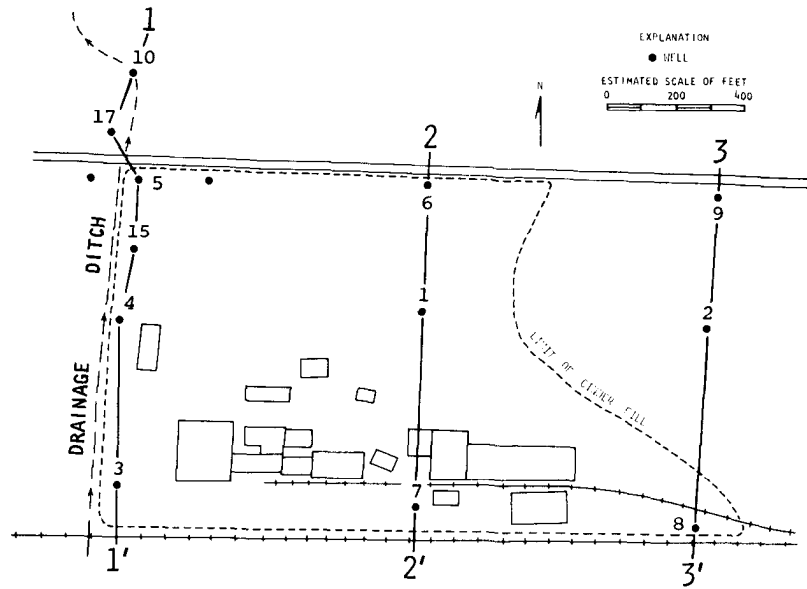

Figure 33. North-south profiles of zinc concentrations in soil — Site B

Aside from the anomalous area around well 5, the maximum depth of zinc penetration on plant property was about 11 feet. As at Site A, no significant lateral migration of zinc was detected beyond the limits of the plant property. Site B has greater surface relief than Site A and is drained considerably better. As a result, there is less recharge occurring through the cinder fill and thus less migration of metals-rich water into the soil. However, there is more metals-rich surface water runoff, resulting in higher zinc concentrations in the soils beneath the creek bed draining the plant property to the north (Figure 34). In Figure 34, the zinc penetration profile between wells 17 and 10 has purposely not been connected. Well 17 is located on the stream bank about 30 feet from the stream bed, and as discussed before, is not representative of zinc concentrations that would be expected in the soils directly beneath the creek. The differences in values at well 17 and those at wells 10 and 11 illustrate the limited horizontal migration of zinc away from the creek valley.

No cross sections are presented that indicate the degree of migration and soil retention for cadmium, copper, and lead for Site B. Inspection shows that the same general relationships exist between these metals and zinc as at Site A. Similarly, the same mechanisms controlling the movement of the metals within the soil profile at Site A are also acting at this site.

Zinc concentrations in water samples collected from wells at Site B are shown in Table 11. All wells finished at the bedrock surface (1D through 9D) produced water containing less than 0.5 mg/l zinc. One sample from well 6D contained 7.8 mg/l zinc but probably was not a representative sample.

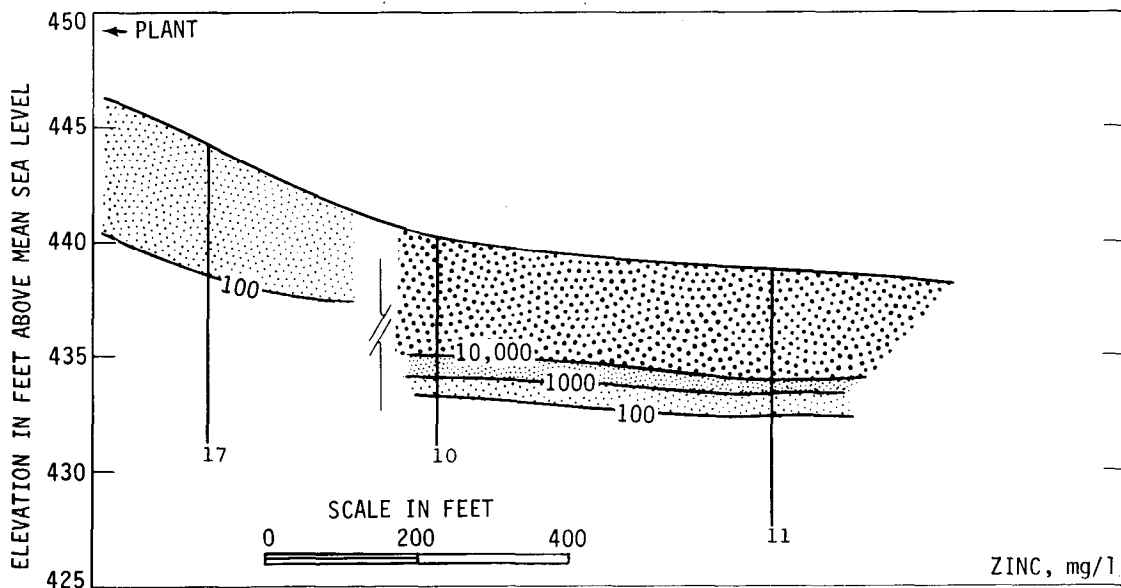

Figure 34. Profile of zinc concentrations in stream bed soil — Site B

**Table 11. Zinc Concentrations in Water Samples from Wells at Site B
(Concentrations in milligrams per liter)**

	1975						1976					
	2-13	3-19	6-18	7-21	8-11	11-18	3-2	4-6	6-8	7-13	7-30	9-9
1S	.39	.11	**	*	*	<.2	*	*	.25	10.	*	*
1M	.25	.007	**				*					
1D		.019	<.7	*	*	<.2	*					*
2S	.056	.034	<.4	*	*	<.2	*	2.7	*	*	*	*
2D	.013	.019	0.7	*	*	<.2	*					*
3S		.044	<.3	*	*	<.2	*	*	*	*	*	*
3D		.018	<.4	*	*		*					*
4S		.020	**	*	*	<.2	*	*	*	*	*	*
4D		.017	<.3	*	*		*					*
5S	110.	140.	29.5	27.1	8.4	8.0	.66	32.5	6.1	11.5	41.6	45.5
5D	.16	.041	**	*	29.2	0.4	*	*				
6S	1.1	.047	**	*	*	<.2	*	*	*	*	*	*
6M	.25	.089	**				*	3.6				
6D	.23	.023	**	*	*		*	7.8				*
7S		.17	**	*	*	<.2	*	*	*	*	*	*
7M		.039	**		*		*					
7D		.011	**	*	*		*					*
8S		.019	**	*	*	0.2	*	4.	*	*	*	*
8M		.21	**				*					
8D												*
9S		.012	**	*	*	1.1	*	3.	*	*	*	*
9D		.01	**	*	*		*					*
10						1.6	*	3.	*	*	*	*
11						4.7	*	*	*	*	*	*
14								*	*	*	*	*
15								*	*	*	*	*
16								2.2	*	*	*	*
17								*	*	*	*	*
CH 1S					*	0.5	*	*	*	*	*	
CH 1D					*	0.7	*					*
CH 2S					*	0.3	*	*	*	*	*	*
CH 2D					*	0.3	*					*

S = shallow; *M* = middle depth; *D* = deep; *CH* = control hole
 * = values less than 0.5 mg/l
 ** = values less than 0.1 mg/l

Aside from a few nonrepresentative zinc contents ranging from 1.6 to 10 mg/l for water from the shallow wells, only one well, 5S, consistently produced water having any significant zinc concentrations. The initial two samples having 110 and 140 mg/l zinc concentrations still could have been reflecting the effects of contaminants introduced during the drilling process. The remaining samples varied from 0.66 to 45.5 mg/l zinc and probably were a result of varying sampling procedures. No total mineral analyses were run on water samples collected at Site B. Table 12 gives results of total mineral analyses from the shallow and deep control holes located southwest of the plant.

The results of work conducted at Site A are directly applicable to the understanding of metals migration at Site B. Cation exchange and precipi-

Table 12. Total Mineral Analyses Data for Control Holes — Site B

	Control Hole 1S		Control Hole 1D	
	mg/l	me/l	mg/l	me/l
Fe	90.		1.7	
Mn	3.80		0.07	
Ca	72.0	3.59	80.0	3.99
Mg	24.9	2.05	33.2	2.73
Sr	0.36	0.01	0.13	
Na	169.	7.35	60.2	2.62
K	2.0	0.05	0.4	0.01
NH ₄	0.7	0.04	Tr	Tr
Ba	0.3		<0.1	
Cd	0.00		0.00	
Cr	0.00		0.00	
Cu	0.00		0.00	
Pb	<0.05		<0.05	
Li	0.01		0.00	
Ni	<0.05		<0.05	
Zn	0.00		0.00	
PO ₄ (filt)	0.0		0.0	
PO ₄ (unfilt)	3.4		0.1	
SiO ₂	16.6		20.2	
F	0.9		0.4	
B	0.2		0.0	
NO ₃	0.3	Tr	18.2	0.29
Cl	130.	3.67	10.	0.28
SO ₄	8.6	.18	149.3	3.11
Alk. (as CaCO ₃)	460.	9.20	286.	5.72
Hard. (as CaCO ₃)	282.	5.64	336.	6.72
TDM	698.		543.	

tation are the principal attenuating mechanisms. The geology at Site B is similar to that at Site A, and therefore desirable for this type of waste disposal activity. The topography of this site is steeper, resulting in better drainage and less downward migration of the metals. The ability to define the migration patterns of the metals with fewer core holes and, piezometers attests to the similarity of the sites and to the knowledge gained at Site A.

Site C

Site C is a secondary zinc smelter located in north-central Illinois. It was a primary smelting facility from 1906 until 1971 when it was converted to secondary smelting operations. Wastes from the plant principally have been in the form of metals-rich cinders, as at Sites A and B. There currently is a 40-foot-high pile of cinders covering about 12 acres in the southeast portion of the plant property. A 1- to 5-foot-thick layer of cinders also covers the remaining 90 acres of the plant complex.

This site was selected because it lies along the Illinois River in an alluvial sand and gravel setting. It also is compatible with Sites A and B with regard to the pollution source (zinc) and period of operation. A

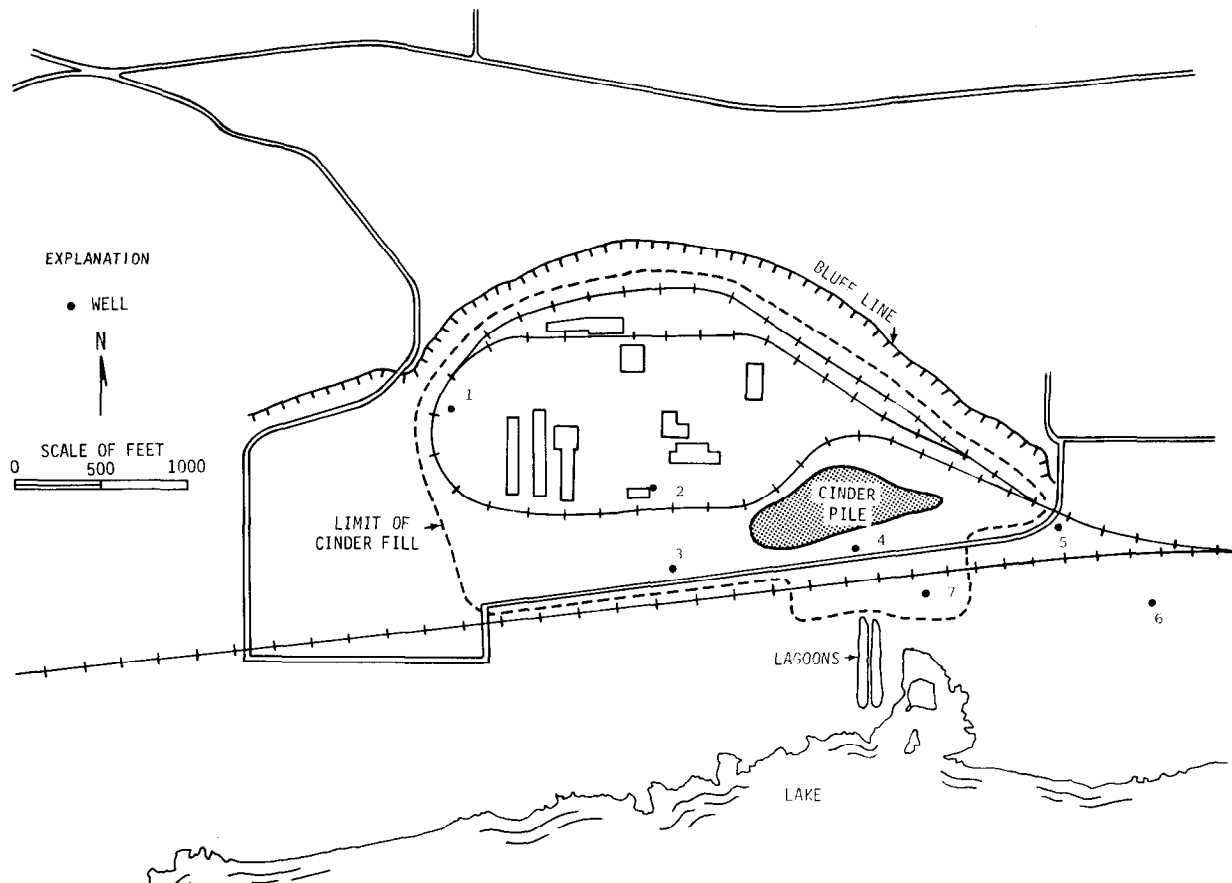

Figure 35. Location map — Site C

limited number of core holes and wells (7 core holes and 14 wells at 7 locations) were constructed at this site (Figure 35). Total well and coring footages are about 347 and 185 feet, respectively.

Geology

The stratigraphic units at Site C differ markedly from those at the other locations. The site is situated on a low level outwash terrace at the edge of the Illinois River floodplain. The outwash (Henry Formation) varies in character and thickness across the site. At the eastern edge of the property, the Henry Formation is predominantly overlain by swamp deposits (Grayslake Peat). Figure 36 shows a cross section which illustrates the nature of the deposits at the site. Data for selected borings are included in the Appendix. No textural or mineralogical analyses were run on the samples collected at this location. Bedrock was not encountered in any of the borings, so the exact thickness of the unconsolidated sediments is unknown. However, available data suggest that the unconsolidated materials are 50 to 100 feet thick, thinning eastward. The stratigraphy developed during this investigation corresponds with previous work in the area by Willman (1973). A brief description of the stratigraphic units follows.

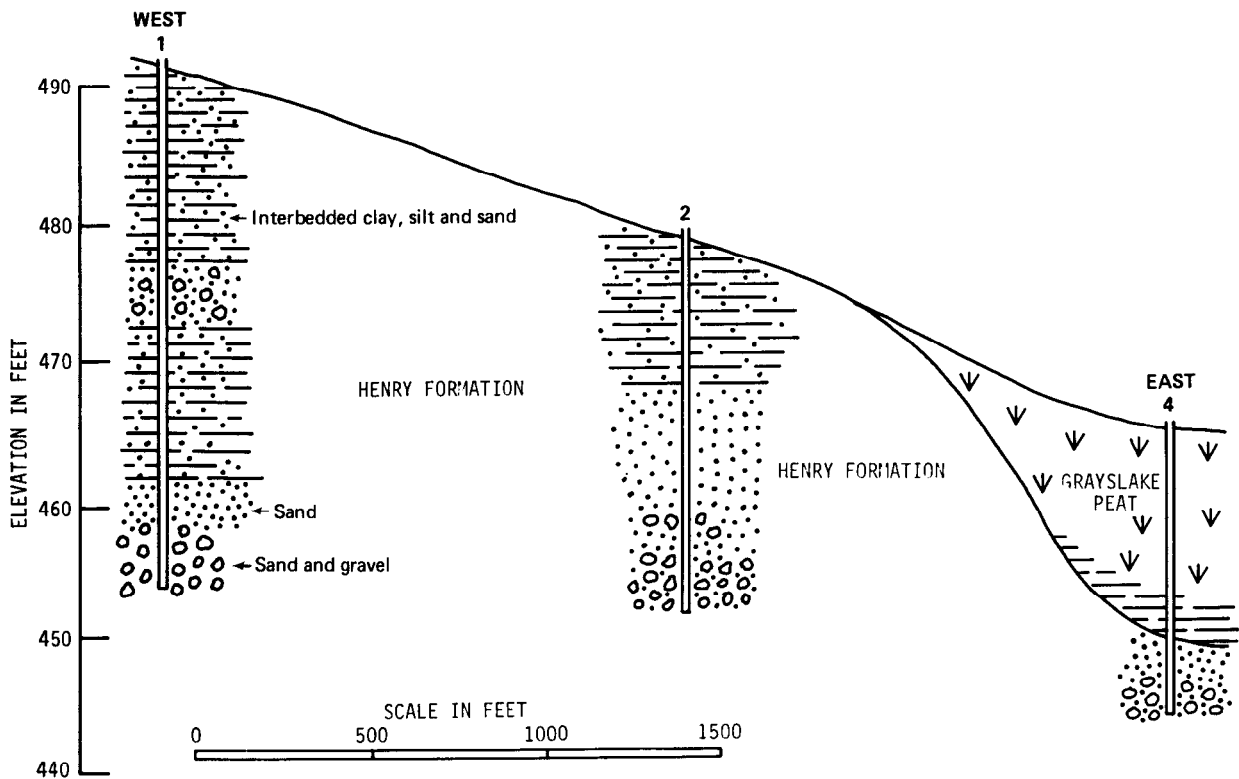

Figure 36. Stratigraphic cross section — Site C

Holocene Stage

- A) Grayslake Peat (0 to 20 feet thick) – Recent accumulation of peat, marl, and muck locally interbedded with silt and silty sand. Light gray to dark gray to black; organic material including wood fragments is abundant. Contains carbonates except at the surface. Represents accumulation of organic material in a wet, poorly drained environment. Silt loam at the base overlying the Henry Formation may represent a transition from alluvial to swampy environment.

Wisconsinan Stage

- B) Henry Formation (3 to 38 feet thick) - Interbedded clay, silt, sand, and gravel. Predominantly silt and clay in upper portion (see Figure 36); probably contains slopewash from adjacent bluffs, especially in the western part of site. Considerable variation in texture vertically and laterally (Figure 36). Typically becomes coarser with depth; sand and gravel are predominant. Contains carbonates except where leached at the surface. Deposited by meltwaters from the Wisconsinan glaciers carrying sediment down the Illinois River Valley. Contains poorly developed Modern Soil; has probably been disturbed by human activity. It is at the surface in the western portion of Site C and underlies the Grayslake Peat in the eastern part of the site.

Hydrology

On the basis of the geologic description of this site, it is obvious that there is a thick permeable sand and gravel deposit associated with the Illinois River lowlands. Two wells owned by the industry are capable of yielding in excess of 500 gallons per minute each.

To determine the hydraulic characteristics of this aquifer a pumping test with 1 observation well (4D) was conducted on August 31, 1976. To allow for a larger pumping rate during the test, an 8-inch-diameter test well (TW1) was constructed 8 feet east of 4D. The well was 32 feet deep and equipped with 10 feet of 7-slot (0.007 inch) wire-wound screen. The well penetrated the top 10 feet of the aquifer.

The well was pumped at a constant rate of 30 gallons per minute for a period of 135 minutes and allowed to recover for a period of 80 minutes. Drawdown and recovery data for wells TW1 and 4D are presented in Figure 37.

Analyses of these data were complicated by the following factors: a) the effects of stored water in the casing were experienced because of the low pumping rate relative to the well diameter; b) most theoretical solutions for type curves require the assumption that flow is uniform through all sections of the well screen (under ordinary circumstances this assumption is valid, but in this case it cannot be accepted because of the closeness of the observation well); and c) the production well (TW1) is partially penetrating at only 17.2 percent, and this low a percentage does not appear in tables of well functions found in the literature.

To solve for the above situation, type curves were generated to fit the field conditions. A modified form of a computer program given by Prickett and Lonquist (1971) was used. Their program was modified to operate in a vertical cross section with radial symmetry about the center of the production well. The program also was transformed to yield a nondimensional well function. The well function for nonleaky aquifers, $W(u)$, used at site A is an example of a mathematically generated type curve. The well function generated in this case is termed $w[u(r/m)y]$ since the drawdown also is a function of the ratios of observation well distance to the aquifer thickness (r/m) and the production well screen length to the aquifer thickness (L/m).

Figures 37a and b show the resulting type curve analyses for the pumped well and observation well, respectively. Since the effective radius of the pumped well is unknown, results of analysis from the pumped well data are considered only an approximation. The accepted computed coefficients of transmissivity, hydraulic conductivity, and storage are 127,000 gpd/ft, 2190 gpd/ft², and 0.094, respectively.

The computed storage coefficient is unexpectedly high. This could be caused by some leakage from materials overlying the defined aquifer. Another possible explanation is the presence of the cinder pile next to the pumping test site. Lowering of water levels by pumpage may allow additional compaction of the aquifer materials under the weight of the cinder pile, resulting in an apparently higher storage coefficient value.

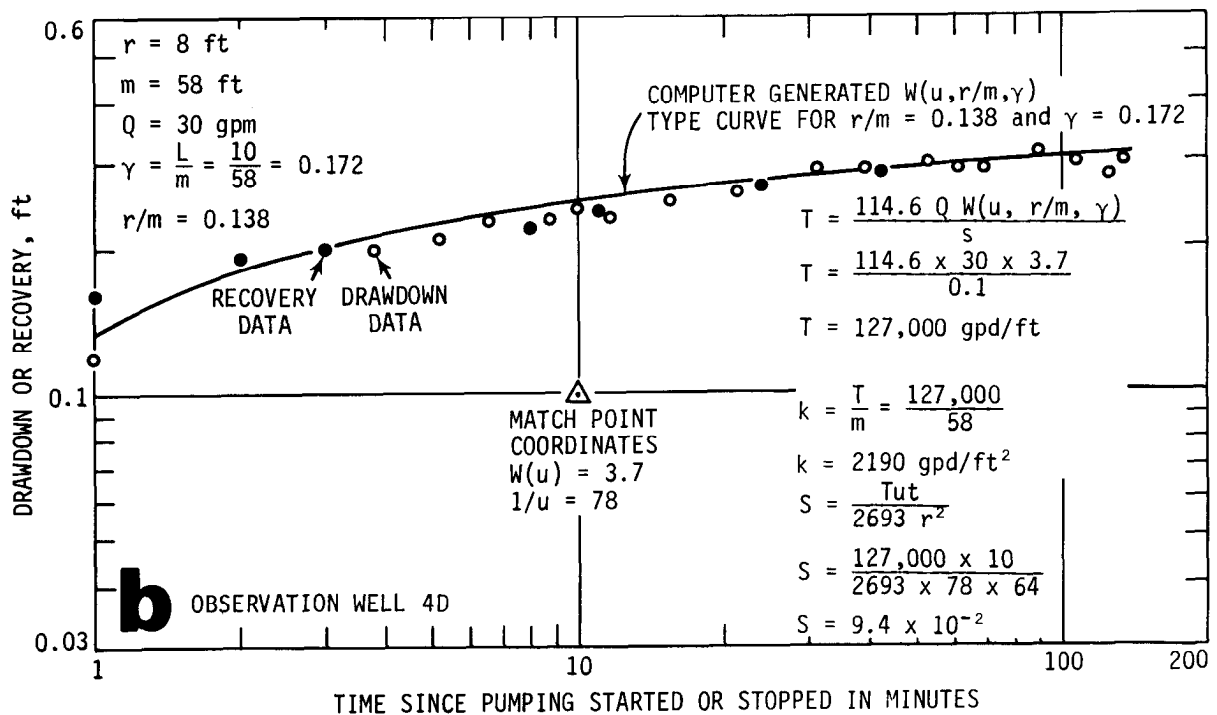
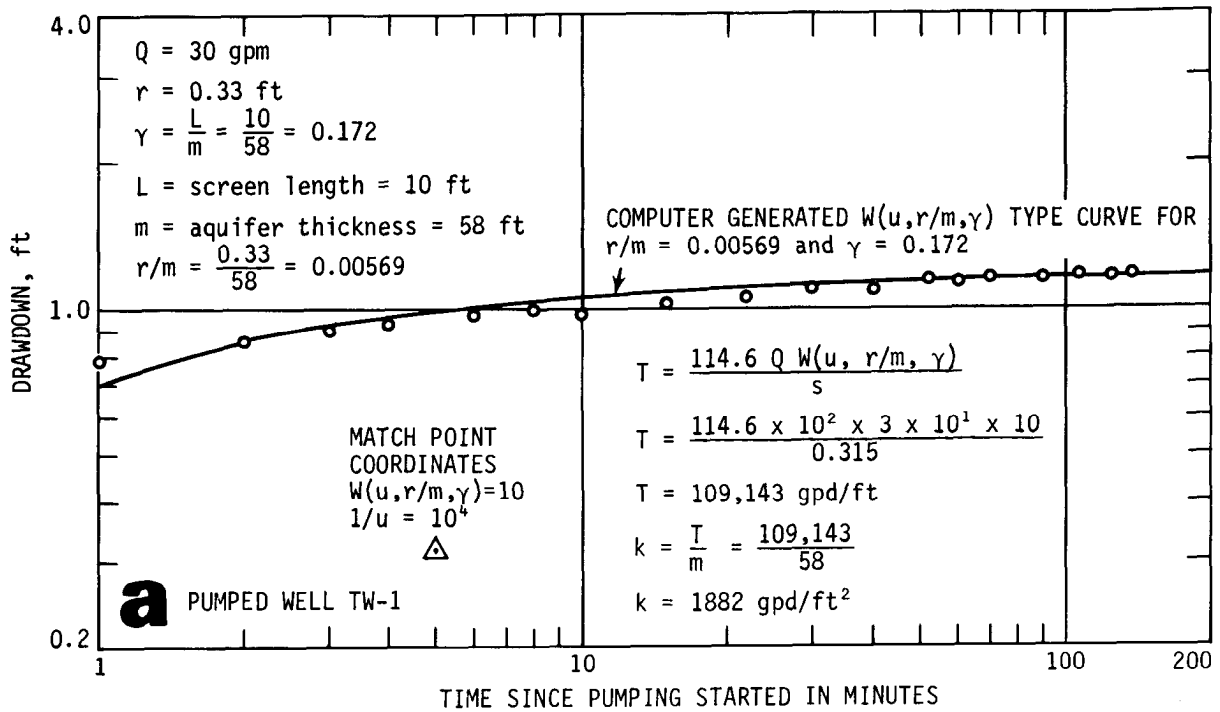

Figure 37. Pumping test data for wells TW1 and 4D — Site C

In an effort to detect any possible shallow groundwater contamination at this site, a series of wells were constructed about 5 to 10 feet below the water table surface and another series of wells were installed about 10 to 15 feet below that. Water level hydrographs for the shallow and deep wells are presented in Figure 38.

Piezometric surface maps were drawn for each round of water level measurements made. Figures 39a and b illustrate the high and low water level configurations for June 1976 and October 1976, respectively. The general direction of groundwater movement is to the south toward the backwater lake and the Illinois River.

Water levels in the deeper wells varied in response to precipitation in a fashion similar to that of the shallow wells. At wells 1 and 2 the vertical movement of water in the drift materials is downward. At all other sites, those closer to the river, the direction of vertical movement is upward. Maximum and minimum water levels for all wells at Site C are summarized in Table 13.

To determine the rate of groundwater movement Darcy's equation was applied as at Site A. On the basis of data presented by Todd (1967), an effective porosity or specific yield of 0.20 was assumed for the aquifer materials. The average rates of movement for June and October 1976 were 23 and 18 ft/day, respectively. These relatively high rates of groundwater movement were to be expected in a permeable sand and gravel aquifer of this type

A soil temperature survey was made at Site C on April 14 and 21, 1976. The locations of the 44 stations are shown in Figure 40. All temperature readings were normalized to the April 14 conditions. The soil temperatures were measured at a depth of 2.3 feet and corrected for depth to the water table by methods given by Cartwright (1968). Lines of equal temperature on a contour interval of two degrees Fahrenheit are shown in Figure 40. High soil temperatures were measured in the area surrounding the complex of industrial buildings. High soil temperatures measured in low ground south of the high mound of cinders are caused by groundwater discharge. At the season of the year when the soil temperature measurements were made, a warm anomaly is expected in areas of groundwater discharge. Groundwater discharge in the vicinity of the cinder pile may be receiving contributions from the regional flow system as well as from locally mounded groundwater in the cinder pile. Groundwater discharge from the cinder pile may be highly contaminated.

The inferred direction of groundwater flow for the study area, as interpreted from the soil temperature, is southward toward the lake. This compares favorably with the direction of groundwater movement determined from water level data (see Figure 39).

Chemical Data

In addition to the analyses of data for geologic interpretation, chemical analyses of the core samples were conducted to define the migration characteristics of the suspected contaminants through the sandy soil

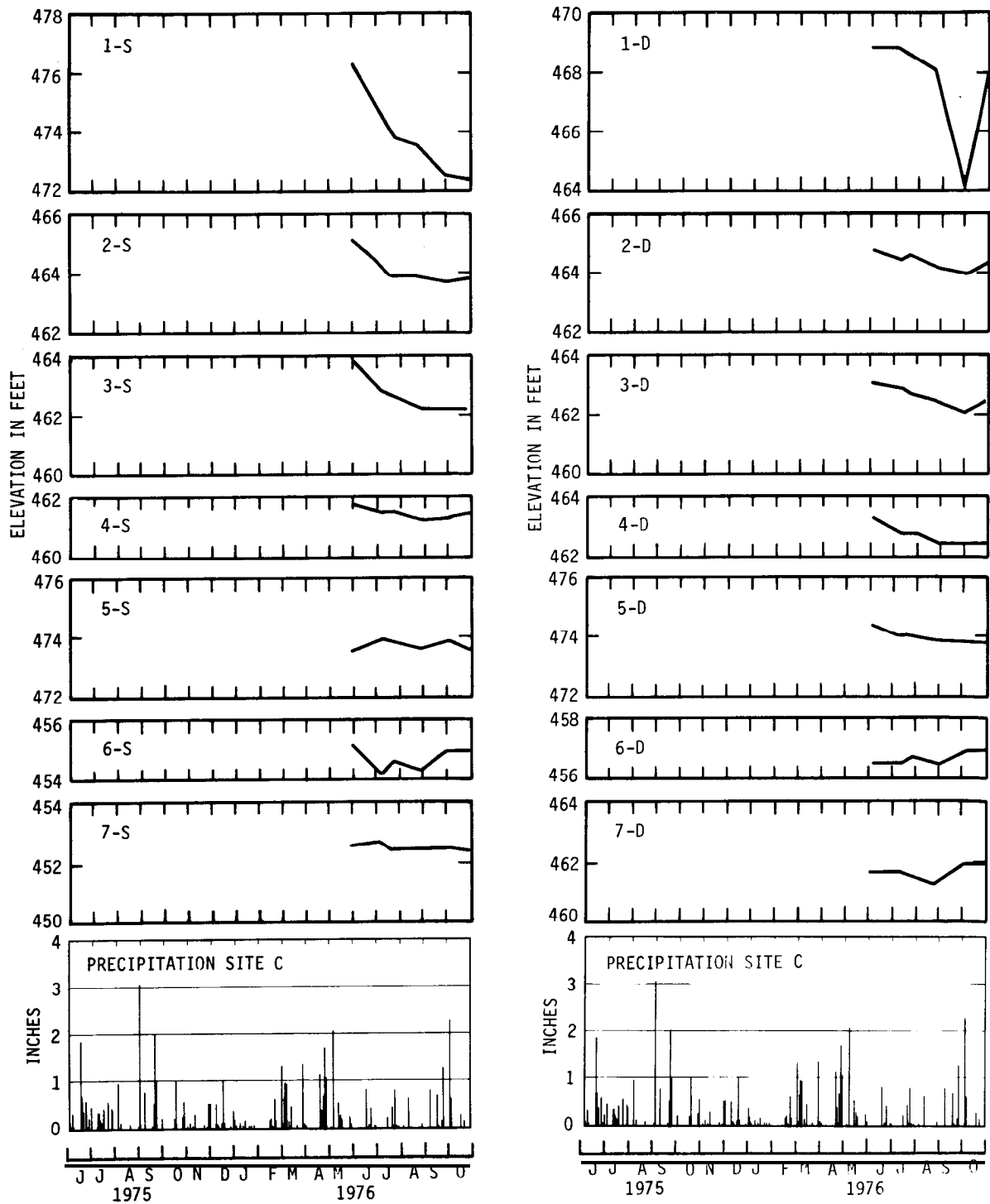

Figure 38. Water level hydrographs for all wells — Site C

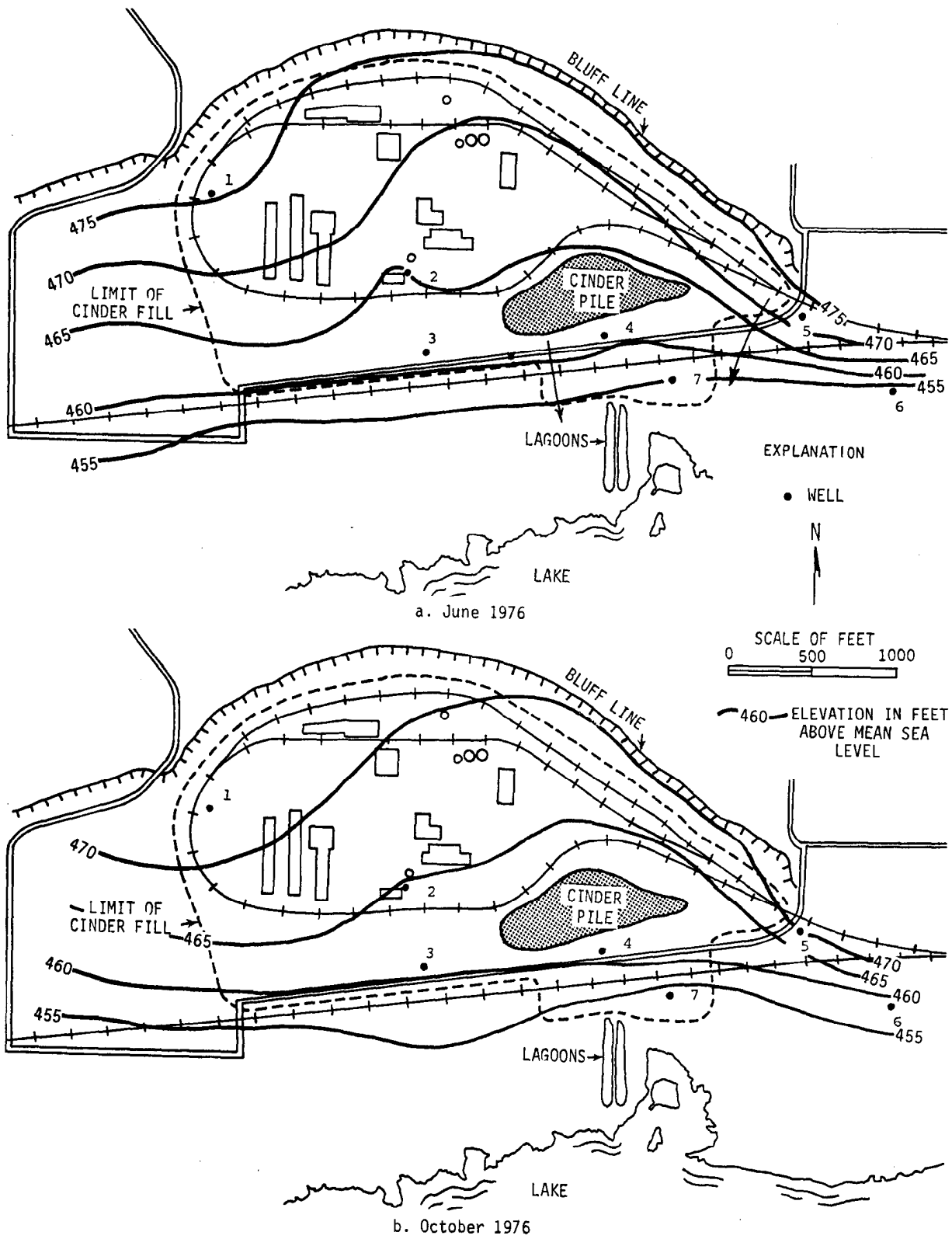

Figure 39. Piezometric surface maps for a) June 1976, and b) October 1976, for shallow wells at Site C

Table 13. Range of Water Level Fluctuations in All Wells — Site C

Well	Land surface elev (ft)	Low			High			Fluctuation (ft)
		Depth below land (ft)	Mean sea level (ft)	Date	Depth below land (ft)	Mean sea level (ft)	Date	
1S	490.98	18.54	472.44	10-26-76	14.56	476.42	6-1-76	3.98
1D	491.04	26.95	464.09	9-29-76	22.20	468.84	7-8-76	4.75
2S	478.92	14.81	464.11	9-29-76	13.32	465.60	6-1-76	1.49
2D	478.76	14.91	463.85	9-29-76	13.02	464.74	6-1-76	1.89
3S	469.58	7.35	462.23	8-24-76	5.68	463.90	6-1-76	1.67
3D	469.88	7.90	461.98	9-29-76	6.92	462.96	6-1-76	0.98
4S	464.82	3.50	461.32	9-29-76	3.02	461.80	6-1-76	0.48
4D	464.66	2.29	462.37	9-29-76	1.41	463.15	6-1-76	0.78
5S	473.56	0.08	473.48	6-1-76	-0.35	473.91	7-8-76	0.43
5D	473.65	-0.19	473.84	10-26-76	-0.79	474.44	6-1-76	0.60
6S	456.29	2.04	454.25	7-8-76	1.00	455.29	6-1-76	1.04
6D	456.37	-0.03	456.40	8-25-76	-0.49	456.86	10-26-76	0.46
7S	467.29	14.98	452.31	10-26-76	14.67	452.62	7-8-76	0.31
7D	467.08	5.74	461.34	8-25-76	5.08	462.00	10-26-76	0.66

S = shallow; D = deep

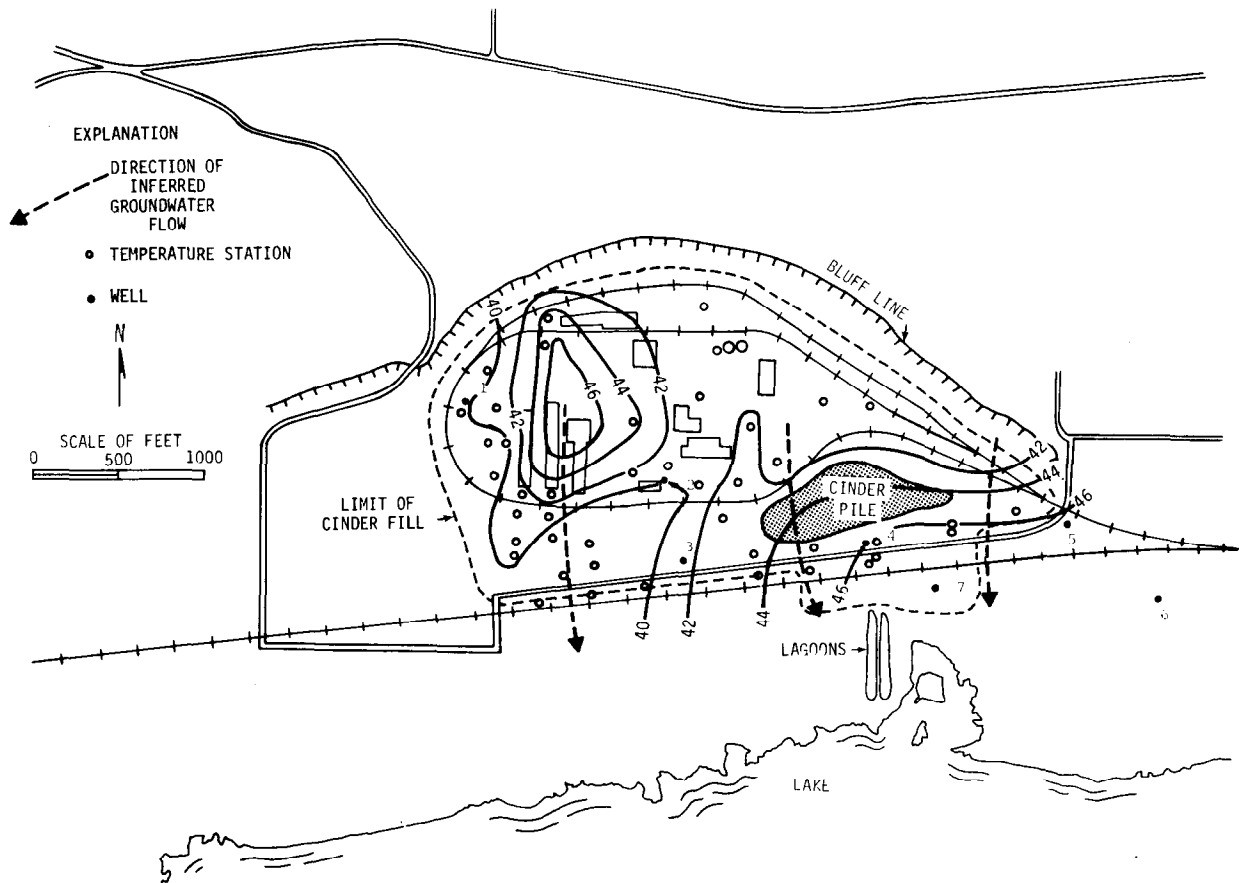

Figure 40. Soil temperature stations and results — Site C

land the effectiveness of these soils in retaining the metal contaminants. Selected analyses are given in the Appendix. As at sites A and B, four elements -- zinc, cadmium, copper, and lead -- were routinely determined.

No control hole was constructed at this site because of the limited time and money available. However, data from the lower segments of all holes at this site suggest that the background concentrations found in the control holes at Sites A and B also are valid at this site. Zinc concentrations in the lower portions of the seven core holes ranged from about 13 to 75 mg/l, cadmium from less than 0.6 to 0.90 mg/l, copper from about 10 to 25 mg/l, and lead from less than 4.0 to 90 mg/l.

The number and locations of core holes at this site were not adequate to define the limits of horizontal migration of the metals in the soil. However, the vertical migration patterns are very similar to those at Sites A and B.

Holes 1, 2, and 3 are located on relatively upland portions of the plant complex. Zinc concentrations in excess of 10,000 mg/l were present in the cinder fill material at the surface. Below the fill, zinc concentrations generally decrease downward through the soil profile in which carbonates have been leached. Cation exchange is the major mechanism of attenuation in this interval.

Below the zone of leaching, carbonates are present, and the pH is assumed to be about 7 to 8. The increase in soil pH causes precipitation to be an important factor in attenuation and is reflected by an increase in zinc concentrations. Examination of the core samples indicates accumulations of zinc carbonate in samples with extremely high zinc levels.

The clays present in the fine-grained surficial geologic material are responsible for a rapid decrease in zinc concentrations just below the cinder fill material, just as at Sites A and B. However, the Henry Formation becomes coarse grained with depth, and appears to be less effective in attenuating zinc movement by cation exchange. The zinc concentrations drop off quickly to background levels below a depth of 16 to 17 feet as a result of the combined action of cation exchange and precipitation.

Holes 4, 5, and 7 also are similar to each other. At each of these locations the fill materials are underlain by the Grayslake Peat, and migration into these highly organic materials is minimal. Information for hole 4 indicates that in addition to cation exchange, soil pH also is a major factor contributing to attenuation. Hole 6 is lowland swampy area with the grayslake peat at the surface and extending to a depth of about 19 feet. The repeated inundation of this location with high metal content surface water has resulted in zinc migration to a depth of about 6 feet into the peat. Analyses of the lake bottom sediments south of the plant indicate that large quantities of heavy metals have left the plant site by surface water mechanisms (Table 14). The metal contents of the lake bottom sediments can be compared with those of the stream bottom sediments at Sites A and B.

Table 14. Concentrations (mg/l) of Trace Elements in Bottom Sediments from Backwater Lake South of Site C

<i>Depth (inches)</i>	Pb	Zn	Cd	Cu
0-3	141	5000	52	128
3-6	119	5000	34	119
6-9	183	4100	104	130
9-12	211	3400	116	109
12-15	42	348	6	47

Vertical migration of cadmium at each location was very similar to that of zinc. Copper and lead above the assumed background levels were limited to the fill materials, indicating little or no vertical migration of these metals into the underlying soils.

The mechanisms retaining the metals in the soil profile at this site are the same as at Sites A and B. Since no cation exchange capacities were determined for core samples at this site, no comparisons can be made concerning the relative effectiveness of the sandy soils versus the clays, silts, and tills. Results of many laboratory studies suggest that the sandy soils would be less effective as an exchange material, although it would be very difficult to substantiate those results from the data collected in this study. However, there does appear to be clear evidence of the high exchange capability of the organic materials at this site.

Zinc concentrations in water samples collected from wells at Site C are presented in Table 15. All deep wells, those finished 15 to 20 feet into the aquifer, produced water containing less than 0.5 mg/l zinc. Wells 1S and 4S produced water containing less than 0.3 to 16.6 mg/l zinc and less than 0.5 to 69.5 mg/l zinc, respectively. As discussed earlier, a large part of this sizable variation in zinc content may be a result of our sampling protocol. In addition, the close proximity of 4S to the cinder pile and the probable resulting highly mineralized water may have affected the well seal. If the first sample (June 1, 1976) had been affected by the drilling process, the gradual failure of the well seal could explain the results of the remaining samples.

The work conducted at this site was limited in scope but substantiates the findings at Sites A and B. The site was selected because it is a sandy environment that poses core sampling problems not encountered at the other sites, and because the effectiveness of sandy soils to retain metals is reportedly low.

The relatively shallow penetration depth of metals concentrations was somewhat surprising. The silty surface materials overlying the sand aquifer and highly organic peat deposits appear to be retaining significant quantities of the metals. The fact that no large amounts of zinc were found in the aquifer indicates that it has not entered the aquifer or else

**Table 15. Zinc Concentrations in Water Samples from Wells at Site C
(Concentrations in milligrams per liter)**

	1976			
	6-1	7-8	7-27	8-25
1S	0.3	13.	16.6	2.7
1D	*	*	*	*
2S	*	*	*	*
2D	*	*	*	*
3S	*	*	*	*
3D	*	*	*	*
4S	69.5	*	4.6	12.1
4D	*	*	*	*
5S	*	*	*	*
5D	*	*	*	*
6S	*	*	*	*
6D	*	*	*	*
7S				
7D	0.3		*	*

S = shallow; D=deep
** = values less than 0.5 mg/l*

is entering it at such a slow rate compared with the regional flow system that it is undetectable.

The data are not sufficient to indicate that this type of geology provides an adequate environmental barrier for this type of disposal activity.

SECTION 6

CONCLUSIONS

1. The vertical and horizontal migration patterns of zinc, cadmium, copper, and lead were defined throughout the soil and shallow aquifer systems at Sites A and B. Vertical migration patterns of the same elements were successfully defined at Site C. In all three cases zinc proved to be the most mobile, followed by cadmium, copper, and lead, in that order.

2. The contamination which occurred at the three zinc smelters has been contained in the general plant areas by attenuation processes in the soil, despite the long period of time and the heavy surface loading of the systems with zinc and other heavy metals. Sites A and B are located in regions generally considered geologically acceptable for such waste disposal. Site C is in what generally is regarded as a sensitive environment for waste disposal, and may not attenuate constituents that are more mobile than those studied here.

3. Two principal mechanisms control the distribution of zinc and other metals at Sites A, B, and C. These are, in order of dominance, cation exchange and precipitation of insoluble metal compounds as a result of pH changes in the infiltrating solutions.

4. Soil coring has been demonstrated to be an effective investigative or research tool in this project. However, proper geologic interpretation and a thorough understanding of soil chemistry is essential to effective use of the technique. Cost analyses and experience gained during this project suggest that coring has limited application to routine groundwater monitoring cases.

5. The use of piezometers or wells for routine monitoring probably is most cost effective and most easily managed. A limited amount of core sampling would provide data for better vertical and horizontal placement of almost all monitoring wells.

6. Proper sampling techniques for collecting representative water samples from monitoring wells have not been determined. Results of a brief experiment in this study suggest that variations as great as 45 to 80 percent in the chemical constituents of water samples could result from improper sampling techniques. Difficulty also was experienced with leakage of surface water through ineffective well seals.

7. Field investigations with geophysical methods show that electrical earth resistivity and soil temperature measurements can be used to gather information rapidly and economically on the lithology of the geologic materials, to define the shallow groundwater flow system and to identify possible zones of contaminated groundwater within the flow system.

8. Geologic environments consisting predominantly of clay, silt, and clay-rich tills have been demonstrated to be effective in retaining the movement of the metals zinc, cadmium, copper, and lead from very concentrated inorganic sources.

REFERENCES

- Berk, W. J., and B. S. Yare. 1977. An Integrated Approach to Delineating Contaminated Ground Water. *Ground Water*, 15(2): 138-145.
- Cartwright, Keros. 1968. Temperature Prospecting for Shallow Glacial and Alluvial Aquifers in Illinois. Illinois State Geological Survey Circular 433.
- Cartwright, Keros. 1974. Tracing Shallow Ground-Water Systems by Soil Temperature. *Water Resources Research*, 10(4): 847-855.
- Cartwright, Keros, and M. R. McComas. 1968. Geophysical Surveys in the Vicinity of Sanitary Landfills in Northeastern Illinois. *Ground Water*, 6(5): 23-30.
- Cartwright, Keros, and P. C. Reed. 1972. Effect of Deep Glacial-Drift Aquifers on Soil Temperatures. Reprint of paper presented at Fall Meeting of the Society of Mining Engineers of AIME, Birmingham, Alabama, Preprint No. 72-I-346, 14 p.
- Cartwright, Keros, and F. B. Sherman. 1972. Electrical Earth Resistivity Surveying in Landfill Investigations. Proceedings of the 10th Annual Engineering and Soils Engineering Symposium, Moscow, Idaho, pp. 77-92.
- Frost, R. R., and R. A. Griffin. 1977. Effect of pH on Adsorption of Copper, Zinc, and Cadmium from Landfill Leachate by Clay Minerals. *Journal of Environmental Science and Health, Part A*, v. 12.
- Gibb, J. P., et al. 1981. Procedures for the Selection of Representative Water Quality Data from Monitoring Wells. Illinois State Water Survey and State Geological Survey Cooperative Groundwater Report 7, 61 p.
- Griffin, R. A., et al. 1976. Attenuation of Pollutants in Municipal Landfill Leachate by Clay Minerals, Part 1 - Column Leaching and Field Verification. *Environmental Geology Note 78*, Illinois State Geological Survey, 34 p.
- Grim, Ralph. 1953. *Clay Mineralogy*. McGraw Hill Book Company, Inc., 384 p.
- Hantush, Mahdi S. 1964. Hydraulics of Wells. *In* *Advances in Hydroscience*, Vol. 1, edited by Ven Te Chow. Academic Press, New York, pp. 284-286.
- Prickett, T. A., and C. G. Lonquist. 1971. Selected Digital Computer Techniques for Groundwater Resource Evaluation. Illinois State Water Survey Bulletin 55, 62 p.

- Todd, David K. 1967. Ground Water Hydrology. John Wiley and Sons, Inc., New York, pp. 23-26.
- Van Nostrand, R. G., and K. I. Cook. 1966. Interpretation of Resistivity Data. Paper 499, U.S. Geological Survey.
- Walton, William C. 1962. Selected Analytical Methods for Well and Aquifer Evaluation. Illinois State Water Survey Bulletin 49, p. 6.
- Willman, H. B. 1973. Geology along the Illinois Waterway - A Basis for Environmental Planning. Illinois State Geological Survey Circular 478.
- Willman, H. B., et al. 1975. Handbook of Illinois Stratigraphy. Illinois State Geological Survey Bulletin 95.
- willman, H. B., and J. C. Frye. 1970. Pleistocene Stratigraphy of Illinois. Illinois State Geological Survey Bulletin 94.

APPENDIX. DATA FROM SELECTED BORINGS

Abbreviations and Symbols

W	moisture content	Cal	calcite
Gs	specific gravity	Dol	dolomite
Gvl	gravel	cts/sec	counts per second
Sd	sand	Zn	zinc
St	silt	Cd	cadmium
Cl	clay	Cu	copper
DI	diffraction index	Pb	lead
M	montmorillonite	CEC	cation exchange capacity
I	illite	N.D.	not detectable
C-K	chlorite-kaolinite	L.S.	land surface



Soil developed



Clay or accretion-gley



Sand



Till



Silt



Bedrock

(6-60-34), etc. = Average percentage of sand-silt-clay excluding gravel

No.	SITE A 2 L.S. = 507.83			Engineering Data				Grain Size					
	Depth of Sample (ft)	Unit Description	Graphic Log	W %	Gs	Void Ratio	Dry Den #/ft ³	Gvl %	Sd %	St %	Cl %		
1	0.5-1.0	PEORIA LOESS (6-60-34)		-	-	-	-	1	7	71	20		
2	1.0-1.5			-	-	-	-	-	-	-	-	-	
3	1.7-2.2			-	-	-	-	0	4	57	39		
4	2.7-3.2			-	-	-	-	1	6	56	38		
5	3.2-3.7			-	-	-	-	-	-	-	-	-	
6	3.7-4.2			-	-	-	-	1	5	57	38		
7	4.2-4.7			-	-	-	-	-	-	-	-	-	
8	4.7-5.2			-	-	24.2	2.76	-	-	-	-	-	
9	5.8-6.3	ROXANA SILT (24-40-36)		-	-	-	-	1	17	52	31		
10	7.3-7.6			-	-	-	-	1	19	44	37		
11	7.7-8.2			-	-	-	-	2	30	33	37		
12	9.1-9.6	-	-	-	-	2	31	30	39				
13	9.7-10.2	BERRY CLAY (37-31-32)		-	-	-	-	1	28	36	36		
14	10.7-11.2			-	-	-	-	2	33	31	36		
15	11.3-11.8			-	-	-	-	10	39	29	32		
16	12.4-12.7			-	-	-	-	-	-	-	-	-	
17	12.7-13.2	HAGARSTOWN		-	-	-	-	3	51	27	22		
18	13.2-13.7			-	-	-	-	-	-	-	-	-	
19	13.7-14.2	-	-	-	-	4	44	38	18				
20	14.7-15.2	GLASFORD FORMATION TILL (29-40-31)		-	-	-	-	7	37	37	26		
21	15.7-16.2			-	-	-	-	5	41	33	26		
22	16.2-16.7			-	-	-	-	-	-	-	-	-	
23	17.7-18.2			-	-	-	-	4	35	36	29		
24	18.2-18.7			-	-	-	-	-	-	-	-	-	
25	18.7-19.2			-	-	-	-	5	30	45	25		
26	19.5-20.0			-	-	-	-	3	32	40	28		
27	20.1-20.6			-	-	13.5	2.70	.39	122	-	-	-	-
28	20.6-21.1			-	-	-	-	-	-	3	28	43	29
29	21.7-22.2			-	-	-	-	-	-	4	28	39	33
30	22.7-23.2			-	-	-	-	-	-	3	35	37	28
31	23.7-24.2			-	-	-	-	-	-	3	30	39	31
32	24.2-24.7			-	-	15.8	2.70*	.45	117	-	-	-	-
33	24.7-25.2			-	-	-	-	-	-	4	30	41	29
34	25.2-25.7			-	-	-	-	-	-	-	-	-	-
35	25.7-26.2	-	-	-	-	-	-	5	30	40	30		
36	26.7-27.2	-	-	-	-	-	-	8	27	42	31		
37	27.7-28.2	-	-	16.7	2.70*	.41	119	-	-	-	-		
39	29.5-30.0	-	-	-	-	-	-	3	30	38	32		
39	31.5-32.0	-	-	-	-	-	-	3	26	38	36		
40	32.7-33.2	-	-	-	-	-	-	5	29	40	31		
41	33.7-34.2	-	-	-	-	-	-	5	29	41	30		
42	34.2-34.7	-	-	-	-	-	-	-	-	-	-		
43	34.7-35.2	-	-	-	-	-	-	3	30	38	32		
44	35.2-35.7	-	-	16.8	2.70*	.43	118	-	-	-	-		
45	36.2-36.7	-	-	-	-	-	-	3	27	42	31		
46	36.9-37.4	-	-	-	-	-	-	1	22	41	37		
47	37.7-38.2	-	-	-	-	-	-	1	20	40	40		
48	38.7-39.2	-	-	-	-	-	-	14	33	37	30		
49	39.3-39.7	-	-	-	-	-	-	-	-	-	-		
50	39.7-40.2	-	-	-	-	-	-	1	18	49	33		
51	42.0-42.5	-	-	-	-	-	-	4	29	41	30		

2 No.	X-Ray Data						Chemical Data					
	DI	M %	I %	C-K %	Cal cts/ sec	Dol cts/ sec	Zn mg/l	Cd mg/l	Cu mg/l	Pb mg/l	pH	CEC meg/ 100g
1	-	-	-	-	-	-	-	-	-	46.	-	-
2	-	-	-	-	-	-	16,000	-	19.	20.	-	-
3	1.4	82	12	6	N.D.	N.D.	-	-	-	-	-	-
4	1.6	84	11	5	N.D.	21	-	-	-	-	6.3	9.2
5	-	-	-	-	-	-	71	.24	35.	34.	-	-
6	1.5	81	13	6	N.D.	15	-	-	-	-	-	-
7	-	-	-	-	-	-	-	-	-	-	-	-
8	1.2	82	11	7	N.D.	N.D.	-	-	-	-	-	-
9	1.1	81	12	7	N.D.	N.D.	670.	.46	26.	35.	-	-
10	-	-	-	-	-	-	430.	N.S.	23.	24.	-	-
11	1.2	87	8	5	N.D.	N.D.	-	-	-	-	-	-
12	1.4	83	11	6	N.D.	N.D.	500.	20.	22.	31.	-	-
13	1.1	75	15	10	N.D.	N.D.	-	-	-	-	-	-
14	0.9	77	13	10	N.D.	18	-	-	-	-	-	-
15	2.1	65	26	9	N.D.	16	320.	7.8	8.0	8.0	-	-
16	-	-	-	-	-	-	350.	-	-	-	-	-
17	1.8	57	31	12	N.D.	10	-	-	-	-	-	-
18	-	-	-	-	-	-	270.	5.0	27.	21.	-	-
19	2.1	25	56	19	N.D.	N.D.	-	-	-	-	-	-
20	2.4	27	57	16	N.D.	25	-	-	-	-	-	-
21	2.1	29	54	17	26	15	1100.	1.6	330.	200.	7.4	7.4
22	-	-	-	-	-	-	-	-	-	-	7.5	5.4
23	1.4	22	53	25	25	18	-	-	-	-	-	-
24	-	-	-	-	-	-	45.	.18	24.	20.	7.4	6.5
25	1.3	43	38	19	19	14	-	-	-	-	-	-
26	1.3	45	36	19	16	14	-	-	-	-	-	-
27	-	-	-	-	-	-	-	-	-	-	-	-
28	1.1	50	31	19	27	15	-	-	-	-	-	-
29	1.3	53	31	16	15	20	37.	.14	27.	26.	-	-
30	1.3	51	32	17	19	17	-	-	-	-	-	-
31	1.0	51	29	20	13	17	-	-	-	-	-	-
32	-	-	-	-	-	-	-	-	-	-	-	-
33	1.4	43	38	19	22	18	-	-	-	-	-	-
34	-	-	-	-	-	-	120.	.12	37.	35.	7.5	5.9
35	1.2	47	34	19	15	15	-	-	-	-	-	-
36	1.2	52	30	18	30	N.D.	-	-	-	-	-	-
37	-	-	-	-	-	-	-	-	-	-	-	-
38	1.1	50	31	19	17	16	36.	~0.4	12.	9.8	-	-
39	1.0	55	26	19	15	16	-	-	-	-	-	-
40	1.2	46	34	20	18	N.D.	-	-	-	-	-	-
41	1.1	45	35	20	17	11	-	-	-	-	-	-
42	-	-	-	-	-	-	33.	~.04	26.	39.	-	-
43	1.3	49	33	18	21	18	-	-	-	-	-	-
44	-	-	-	-	-	-	-	-	-	-	-	-
45	1.1	51	31	18	22	15	-	-	-	-	-	-
46	0.9	76	14	10	12	N.D.	39.	.16	21.	25.	-	-
47	1.1	80	12	8	15	16	-	-	-	-	-	-
48	1.2	31	44	25	30	19	-	-	-	-	-	-
49	-	-	-	-	-	-	47.	.22	27.	23.	-	-
50	1.0	57	26	17	15	20	-	-	-	-	-	-
51	1.1	37	39	24	18	23	-	-	-	-	-	-

No.	SITE A 2 L.S.=507.83			Engineering Data				Grain Size			
	Depth of Sample (ft)	Unit Description	Graphic Log	W %	Gs	Void Ratio	Dry Den # / ft ³	Gvl %	Sd %	St %	Cl %
52	42.7-43.2	GLASFORD FORMATION TILL		—	—	—	—	3	27	40	33
53	43.2-43.7			14.4	2.70*	.39	121	—	—	—	—
54	43.7-44.1	LIERLE CLAY (25-40-35)		—	—	—	—	5	31	43	26
55	44.7-45.2			—	—	—	—	2	24	39	37
56	45.8-46.3			—	—	—	—	2	25	38	37
57	46.3-46.8			17.7	2.70	.49	113	—	—	—	—
58	46.8-47.2			—	—	—	—	2	26	41	33
59	47.2-47.7			—	—	—	—	—	—	—	—
60	47.7-48.2			—	—	—	—	4	25	44	31
61	48.7-49.2	BANNER FORMATION TILL (25-45-30)		—	—	—	—	4	30	41	29
62	50.1-50.4			—	—	—	—	8	32	41	27
63	50.4-51.1			—	—	—	—	0	36	45	19
64	51.7-52.2			—	—	—	—	1	21	52	27
65	52.7-53.2			—	—	—	—	3	21	44	35
66	53.3-53.8			10.8	2.70	.30	130	—	—	—	—
67	54.3-54.6			—	—	—	—	—	—	—	—
68	54.7-55.2			—	—	—	—	2	18	47	34
69	56.2-56.7			—	—	—	—	4	22	44	34
70	57.2-57.7			—	—	—	—	4	22	45	33
71	58.0-58.5	13.6	2.70*	.37	123	—	—	—	—		
72	58.5-59.0	—	—	—	—	—	—	—	—		
73	59.0-59.5	BEDROCK		—	—	—	—	4	22	44	34

*Estimate

2 No.	X-Ray Data						Chemical Data					
	DI	M %	I %	C-K %	Cal cts/ sec	Dol cts/ sec	Zn mg/l	Cd mg/l	Cu mg/l	Pb mg/l	pH	CEC meg/ 100g
52	0.8	82	9	9	N.D.	12	420.	—	—	—	—	—
53	—	—	—	—	—	—	—	—	—	—	—	—
54	1.6	49	36	15	34	28	—	—	—	—	7.6	4.9
55	1.4	43	39	18	16	30	—	—	—	—	—	—
56	1.6	60	28	12	N.D.	15	260.	.24	83.	130.	7.5	5.4
57	—	—	—	—	—	—	—	—	—	—	—	—
58	1.7	28	51	21	N.D.	18	—	—	—	—	—	—
59	—	—	—	—	—	—	58.	.08	43.	32.	—	—
60	1.4	31	47	22	30	28	—	—	—	—	—	—
61	1.4	21	54	25	34	24	—	—	—	—	—	—
62	1.8	25	54	21	61	25	41.	.28	29.	19.	—	—
63	1.6	24	53	23	33	18	57.	.06	10.	8.0	—	—
64	—	—	—	—	—	—	—	—	—	—	—	—
65	1.2	21	51	28	33	11	—	—	—	—	—	—
66	—	—	—	—	—	—	—	—	—	—	—	—
67	—	—	—	—	—	—	76.	<.04	18.	11.	—	—
68	1.3	20	52	28	37	20	—	—	—	—	—	—
69	1.1	18	51	31	46	22	—	—	—	—	—	—
70	1.3	19	53	28	50	22	—	—	—	—	—	—
71	—	—	—	—	—	—	—	—	—	—	—	—
72	—	—	—	—	—	—	79.	.42	36.	32.	—	—
73	1.2	17	52	31	29	20	—	—	—	—	—	—

No.	SITE A 9 L.S. = 504.39			Engineering Data				Grain Size			
	Depth of Sample (ft)	Unit Description	Graphic Log	W %	GS	Void Ratio	Dry Den #/ft ³	Gvl %	Sd %	St %	Cl %
1	0.0-0.5	PEORIA LOESS (11-58-31)		-	-	-	-	-	-	-	-
2	1.0-1.5		-	-	-	-	1	12	59	29	
3	1.5-2.0		24.9	-	-	-	-	-	-	-	
4	2.0-2.5		-	-	-	-	1	11	56	33	
5	2.5-3.0	ROXANA SILT & BERRY CLAY		-	-	-	-	-	-	-	
6	3.5-4.0		-	-	-	-	1	18	38	44	
7	4.0-4.5		24.5	-	-	-	-	-	-	-	
8	4.5-5.0		-	-	-	-	0	19	55	26	
9	6.0-6.5		-	-	-	-	1	28	37	35	
10	6.5-7.0	GLASFORD FORMATION TILL (35-34-31)		15.8	-	-	-	1	34	29	37
11	8.0-8.5		-	-	-	-	1	31	31	38	
12	8.5-9.0		-	-	-	-	-	-	-	-	
13	9.5-10.0		-	-	-	-	2	38	27	35	
14	10.5-11.0		-	-	-	-	1	51	23	26	
15	11.0-11.5		28.2	-	-	-	-	-	-	-	
16	12.0-12.5		-	-	-	-	3	40	35	25	
17	12.5-13.0		-	-	-	-	3	40	40	20	
18	13.5-13.8		-	-	-	-	-	-	-	-	
19	14.5-15.0		11.0	-	-	-	-	-	-	-	
20	16.0-16.5		11.0	-	-	-	-	-	-	-	
21	18.5-19.0		-	-	-	-	3	34	39	27	
22	22.5-23.0		-	-	-	-	6	34	39	27	
23	24.5-25.0		14.8	-	-	-	-	-	-	-	
24	26.5-27.0	-	-	-	-	5	33	39	28		
25	32.0-32.5	8.8	-	-	-	7	38	33	29		
26	34.0-34.5	13.2	-	-	-	-	-	-	-		
27	35.5-36.0	-	-	-	-	4	36	37	27		
28	37.5-38.0	12.9	-	-	-	-	-	-	-		
29	39.5-40.0	-	-	-	-	3	33	37	30		
30	41.0-41.5	-	-	-	-	6	33	38	29		
31	41.5-42.0	-	-	-	-	3	25	39	36		
32	42.0-42.5	15.7	-	-	-	-	-	-	-		
33	42.5-43.0	-	-	-	-	11	30	42	28		
34	49.3-49.5	13.5	-	-	-	-	-	-	-		
35	50.5-51.0	-	-	-	-	4	30	45	21		
36	51.5-52.0	-	-	-	-	3	38	44	18		
37	54.0-54.5	16.0	-	-	-	-	-	-	-		
38	54.5-55.0	-	-	-	-	0	33	50	17		
		BEDROCK									

9 No.	X-Ray Data						Chemical Data					
	DI	M %	I %	C-K %	Cal cts/ sec	Dol cts/ sec	Zn mg/1	Cd mg/1	Cu mg/1	Pb mg/1	pH	CEC meg/ 100g
1	-	-	-	-	-	-	1100.	2.0	19.	34.	-	-
2	-	-	-	-	-	-	-	-	-	-	-	-
3	-	-	-	-	-	-	-	-	-	-	-	-
4	-	-	-	-	-	-	-	-	-	-	6.0	5.9
5	-	-	-	-	-	-	1600.	2.4	21.	31.	-	-
6	-	-	-	-	-	-	23.	<.12	12.	12.	-	-
7	-	-	-	-	-	-	-	-	-	-	-	-
8	-	-	-	-	-	-	-	-	-	-	-	-
9	-	-	-	-	-	-	-	-	-	-	-	-
10	-	-	-	-	-	-	38.	<.12	11.	16.	-	-
11	-	-	-	-	-	-	-	-	-	-	-	-
12	-	-	-	-	-	-	46.	-	-	-	-	-
13	-	-	-	-	-	-	-	-	-	-	-	-
14	-	-	-	-	-	-	-	-	-	-	-	-
15	-	-	-	-	-	-	60.	-	-	-	-	-
16	-	-	-	-	-	-	-	-	-	-	-	-
17	-	-	-	-	-	-	39.	-	-	-	-	-
18	-	-	-	-	-	-	50.	-	-	-	-	-
19	-	-	-	-	-	-	-	-	-	-	-	-
20	-	-	-	-	-	-	-	-	-	-	-	-
21	-	-	-	-	-	-	-	-	-	-	-	-
22	-	-	-	-	-	-	-	-	-	-	-	-
23	-	-	-	-	-	-	-	-	-	-	-	-
24	-	-	-	-	-	-	-	-	-	-	-	-
25	-	-	-	-	-	-	-	-	-	-	-	-
26	-	-	-	-	-	-	-	-	-	-	-	-
27	-	-	-	-	-	-	-	-	-	-	-	-
28	-	-	-	-	-	-	-	-	-	-	-	-
29	-	-	-	-	-	-	-	-	-	-	-	-
30	-	-	-	-	-	-	-	-	-	-	-	-
31	-	-	-	-	-	-	-	-	-	-	-	-
32	-	-	-	-	-	-	-	-	-	-	-	-
33	-	-	-	-	-	-	-	-	-	-	-	-
34	-	-	-	-	-	-	-	-	-	-	-	-
35	-	-	-	-	-	-	-	-	-	-	-	-
36	-	-	-	-	-	-	-	-	-	-	-	-
37	-	-	-	-	-	-	-	-	-	-	-	-
38	-	-	-	-	-	-	-	-	-	-	-	-

No.	SITE A 10 L.S. = 504.16			Engineering Data				Grain Size			
	Depth of Sample (ft)	Unit Description	Graphic Log	W %	Gs	Void Ratio	Dry Den #/ft ³	Gvl %	Sd %	St %	Cl %
1	0.5-1.0	FILL		—	—	—	—	—	—	—	—
2	1.5-2.0			—	—	—	—	—	—	—	—
3	2.0-2.5	ROXANA SILT		22.0	—	—	—	0	15	51	34
4	3.0-3.5			—	—	—	—	—	—	—	—
5	4.5-5.0			—	—	—	—	—	—	—	—
6	5.0-5.7			—	—	—	—	1	16	61	23
7	6.0-6.5	BERRY CLAY (24-36-40)		—	—	—	—	0	21	36	43
8	7.0-7.5			—	—	—	—	0	23	37	40
9	9.0-9.5			—	—	—	—	—	—	—	—
10	9.5-10.0			—	—	—	—	—	—	—	—
11	10.0-10.5			—	—	—	—	—	—	—	—
12	10.7-11.5	GLASFORD FORMATION TILL (34-43-23)		16.3	—	—	—	1	29	35	36
13	11.5-12.0			—	—	—	—	—	—	—	—
14	12.5-13.0			—	—	—	—	5	33	39	28
15	13.5-14.0			—	—	—	—	6	33	41	26
16	15.5-16.0	GLASFORD FORMATION TILL (34-43-23)		—	—	—	—	—	—	—	—
17	16.0-16.5			—	—	—	—	3	28	43	29
18	17.5-18.0			—	—	—	—	1	59	25	16
19	18.0-18.5			—	—	—	—	—	—	—	—
20	19.5-20.0			—	—	—	—	0	47	44	9
21	20.0-20.5			—	—	—	—	0	16	72	12
22	20.5-21.0			—	—	—	—	—	—	—	—
23	24.5-25.0			—	—	—	—	5	43	34	23
24	25.0-25.5			—	—	—	—	3	15	47	38
25	25.5-26.0			—	—	—	—	—	—	—	—
26	30.5-31.0			—	—	—	—	—	—	—	—
27	33.5-34.0	—	—	—	—	—	—	—	—		

10 No.	X-Ray Data						Chemical Data					
	DI	M %	I %	C-K %	Cal cts/ sec	Dol cts/ sec	Zn mg/l	Cd mg/l	Cu mg/l	Pb mg/l	pH	CEC meg/ 100g
1	-	-	-	-	-	-	80,000	39.	68,000	9,200	5.65	-
2	-	-	-	-	-	-	840.	4.1	14.	18.	6.75	-
3	-	-	-	-	-	-	-	-	-	-	-	-
4	-	-	-	-	-	-	400.	1.2	17.	16.	6.89	-
5	-	-	-	-	-	-	680.	4.5	14.	13.	6.15	-
6	-	-	-	-	-	-	400.	2.9	10.	12.	6.10	-
7	-	-	-	-	-	-	680	5.8	9.4	14.	5.95	-
8	-	-	-	-	-	-	800.	2.4	5.6	10.	5.52	-
9	-	-	-	-	-	-	1200.	3.0	8.2	19.	5.55	5.9
10	-	-	-	-	-	-	1800.	-	-	-	5.30	-
11	-	-	-	-	-	-	2000.	3.8	44.	60.	5.80	5.9
12	-	-	-	-	-	-	1500	-	-	-	5.38	-
13	-	-	-	-	-	-	1600	2.4	18.	10.	5.48	2.8
14	-	-	-	-	-	-	200.	1.0	16.	12.	7.55	3.1
15	-	-	-	-	-	-	-	-	-	-	-	-
16	-	-	-	-	-	-	41.	.28	13.	5.9	-	-
17	-	-	-	-	-	-	-	-	-	-	-	-
18	-	-	-	-	-	-	-	-	-	-	-	-
19	-	-	-	-	-	-	91.	1.8	14.	8.0	-	-
20	-	-	-	-	-	-	-	-	-	-	-	-
21	-	-	-	-	-	-	-	-	-	-	-	-
22	-	-	-	-	-	-	21.	.21	11.	6.6	-	-
23	-	-	-	-	-	-	-	-	-	-	-	-
24	-	-	-	-	-	-	-	-	-	-	-	-
25	-	-	-	-	-	-	21.	.12	7.4	2.8	-	-
26	-	-	-	-	-	-	41.	.15	11.	10.0	-	-
27	-	-	-	-	-	-	43.	.08	14.	12.0	-	-

SITE A 12 L.S. = 508.57				Engineering Data				Grain Size			
No.	Depth of Sample (ft)	Unit Description	Graphic Log	W %	Gs	Void Ratio	Dry Den #/ft ³	Gvl %	Sd %	St %	Cl %
1	1.5-2.0	FILL		—	—	—	—	—	—	—	—
2	3.5-4.0	PEORIA LOESS		28.5	—	—	—	0	47	10	43
3	5.0-5.5			—	—	—	—	0	3	72	25
4	6.0-6.5			—	—	—	—	5	42	29	29
5	7.5-8.0			—	—	—	—	—	—	—	—
6	8.0-8.5	ROXANA SILT (37-31-32)		—	—	—	—	1	37	30	33
7	9.5-10.0			—	—	—	—	—	—	—	—
8	10.6-11.3			22.0	—	—	—	2	30	35	35
9	11.5-12.0	BERRY CLAY (34-31-35)		—	—	—	—	1	29	34	37
10	12.0-12.5			—	—	—	—	1	30	44	26
11	13.5-14.0			15.3	—	—	—	3	43	15	42
12	14.0-14.5	HAGARSTOWN MEMBER (36-34-30)		—	—	—	—	3	31	34	35
13	14.5-15.0			—	—	—	—	1	41	33	26
14	15.0-15.5			17.4	—	—	—	—	—	—	—
15	15.5-16.0			—	—	—	—	—	—	—	—
16	16.0-16.5	GLASFORD FORMATION TILL (30-38-32)		—	—	—	—	4	34	36	30
17	16.5-17.0			—	—	—	—	3	48	32	30
18	17.0-17.5			—	—	—	—	5	28	32	40
19	18.0-18.5			—	—	—	—	—	—	—	—
20	19.2-19.8			—	—	—	—	6	32	39	29
21	20.5-21.0			—	—	—	—	—	—	—	—
22	21.5-22.0			—	—	—	—	9	28	44	28
23	23.0-23.5			—	—	—	—	—	—	—	—
24	23.5-24.0			—	—	—	—	1	12	52	36
25	26.0-26.5	—	—	—	—	—	—	—	—		

SITE A 1 L.S. = 506.63				Engineering Data				Grain Size			
No.	Depth of Sample (ft)	Unit Description	Graphic Log	W %	Gs	Void Ratio	Dry Den #/ft ³	Gvl %	Sd %	St %	Cl %
1	0.0-0.5	FILL		—	—	—	—	—	—	—	—
2	1.0-1.5	PEORIA LOESS		—	—	—	—	1	12	63	25
3	1.5-2.0			—	—	—	—	0	4	60	36
4	2.0-2.3			—	—	—	—	—	—	—	—
5	3.5-4.0			—	—	—	—	—	—	—	—
6	4.0-4.5	ROXANA SILT		20.7	—	—	—	—	—	—	—
7	4.5-5.0			—	—	—	—	1	18	49	33
8	5.5-6.0			—	—	—	—	—	—	—	—
9	6.0-6.5			—	—	—	—	2	22	45	33
10	6.5-7.0			—	—	—	—	—	—	—	—
11	8.0-8.5	BERRY CLAY		—	—	—	—	—	—	—	—
12	8.5-9.0			—	—	—	—	1	33	39	28
13	9.0-9.5			—	—	—	—	2	36	30	34
14	11.5-12.0	GLASFORD FORMATION TILL		—	—	—	—	1	32	32	36
15	13.0-13.5			—	—	—	—	12	36	38	26
16	14.0-14.5			—	—	—	—	—	—	—	—
17	15.0-15.5			—	—	—	—	12	37	32	31
18	15.5-16.0			11.7	—	—	—	—	—	—	—
19	16.0-16.5			—	—	—	—	2	34	39	37
20	17.0-17.5	—	—	—	—	—	—	—	—		

12 No.	X-Ray Data						Chemical Data					
	DI	M %	I %	C-K %	Cal cts/ sec	Dol cts/ sec	Zn mg/l	Cd mg/l	Cu mg/l	Pb mg/l	pH	CEC meg/ 100g
1	-	-	-	-	-	-	57,000	24.	17.	14.	-	-
2	-	-	-	-	-	-	9,500	36.	18.	42.	-	-
3	-	-	-	-	-	-	-	-	-	-	-	-
4	-	-	-	-	-	-	4,700	-	-	-	-	-
5	-	-	-	-	-	-	4,600	15.	43.	55.	-	-
6	-	-	-	-	-	-	-	-	-	-	-	-
7	-	-	-	-	-	-	7,800	-	-	-	-	-
8	-	-	-	-	-	-	-	-	-	-	-	-
9	-	-	-	-	-	-	8,900	32.	11.	14.	-	-
10	-	-	-	-	-	-	-	-	-	-	-	-
11	-	-	-	-	-	-	6,200	-	-	-	4.8	2.9
12	-	-	-	-	-	-	-	-	-	-	-	-
13	-	-	-	-	-	-	-	-	-	-	-	-
14	-	-	-	-	-	-	7,400	31.	15.	19.	4.9	3.7
15	-	-	-	-	-	-	3,700	29.	14.	7.9	-	-
16	-	-	-	-	-	-	-	-	-	-	-	-
17	-	-	-	-	-	-	-	-	-	-	-	-
18	-	-	-	-	-	-	-	-	-	-	-	-
19	-	-	-	-	-	-	1,200.	12.	17.	12.	-	-
20	-	-	-	-	-	-	-	-	-	-	-	-
21	-	-	-	-	-	-	190.	1.6	17.	9.6	-	-
22	-	-	-	-	-	-	-	-	-	-	-	-
23	-	-	-	-	-	-	290.	1.8	15.	7.6	-	-
24	-	-	-	-	-	-	-	-	-	-	-	-
25	-	-	-	-	-	-	150.	1.3	14.	10.	-	-

C/1 No.	x-Ray Data						Chemical Data					
	DI	M %	I %	C-K %	Cal cts/ sec	Dol cts/ sec	Zn mg/l	Cd mg/l	Cu mg/l	Pb mg/l	pH	CEC meg/ 100g
1	-	-	-	-	-	-	65000.	8.0	7900.	4700.	-	-
2	-	-	-	-	-	-	4500.	-	-	-	-	-
3	-	-	-	-	-	-	-	-	-	-	-	-
4	-	-	-	-	-	-	4,600.	-	-	-	-	-
5	-	-	-	-	-	-	8,600.	1.1	18.	44.	-	-
6	-	-	-	-	-	-	-	-	-	-	-	-
7	-	-	-	-	-	-	1,400.	-	-	-	-	-
8	-	-	-	-	-	-	2,000.	-	-	-	-	-
9	-	-	-	-	-	-	-	-	-	-	-	-
10	-	-	-	-	-	-	1,800.	-	-	-	-	-
11	-	-	-	-	-	-	1,800.	1.6	67.	55.	-	-
12	-	-	-	-	-	-	-	-	-	-	-	-
13	-	-	-	-	-	-	1,300.	-	-	-	-	-
14	-	-	-	-	-	-	1,800.	-	-	-	-	-
15	-	-	-	-	-	-	1,700.	3.6	15.	12.	-	-
16	-	-	-	-	-	-	1,800.	-	-	-	6.7	4.5
17	-	-	-	-	-	-	240.	.24	26.	21.	7.5	4.5
18	-	-	-	-	-	-	-	-	-	-	-	-
19	-	-	-	-	-	-	84.	-	-	-	-	-
20	-	-	-	-	-	-	40.	<.08	10.	9.6	7.6	3.2

No.	SITE A CH-1 L.S. = 487			Engineering Data				Grain Size				
	Depth of Sample (ft.)	Unit Description	Graphic Log	W %	Gs	Void Ratio	Dry Den #/ft ³	Gvl %	Sd %	St %	Cl %	
1	2.0-2.5	PEORIA LOESS		-	-	-	-	0	4	51	45	
2	3.5-4.0			-	-	-	-	0	4	59	37	
3	4.5-5.0	ROXANA SILT		-	-	-	-	0	14	52	34	
4	6.0-6.5			-	-	-	-	-	-	-	-	-
5	7.5-7.7			-	-	-	-	0	16	27	27	
6	8.0-8.5	BERRY CLAY		-	-	-	-	-	-	-	-	
7	9.0-9.5			-	-	-	-	2	3	61	36	
8	10.7-11.0			-	-	-	-	2	28	40	32	
9	11.0-11.5	GLASFORD FORMATION TILL		-	-	-	-	-	-	-	-	
10	13.0-13.2			-	-	-	-	2	35	36	29	
11	13.5-14.0			-	-	-	-	-	-	-	-	-
12	14.0-14.2			-	-	-	-	2	36	33	31	
13	15.2-15.5			-	-	-	-	3	33	39	28	
14	16.8-17.3			-	-	-	-	-	-	-	-	-
15	17.5-18.0			-	-	-	-	3	3	3	41	26
16	21.0-21.5			-	-	-	-	22	31	37	32	
17	23.0-23.5			-	-	-	-	-	-	-	-	-
18	23.5-24.0			-	-	-	-	5	33	42	25	
19	25.5-26.0			-	-	-	-	-	-	-	-	-
20	28.2-28.5			-	-	-	-	5	31	42	27	
21	30.0-30.5			-	-	-	-	4	30	42	28	
22	33.5-33.8			-	-	-	-	6	33	42	25	
23	34.8-35.3			-	-	-	-	-	-	-	-	-
24	37.3-37.8	-	-	-	-	-	-	-	-	-		
25	38.3-38.7	-	-	-	-	4	30	40	30			
26	39.3-39.8	-	-	-	-	-	-	-	-	-		
27	40.7-41.0	-	-	-	-	8	36	36	28			
28	42.3-42.8	-	-	-	-	-	-	-	-	-		
29	44.7-45.0	-	-	-	-	3	31	41	28			
30	47.8-48.3	-	-	-	-	-	-	-	-	-		
31	48.7-49.0	-	-	-	-	6	24	45	31			
32	50.8-51.1	-	-	-	-	3	24	46	30			
33	52.5-52.8	LIERLE CLAY		-	-	-	-	0	14	54	32	
34	53.5-54.0			-	-	-	-	-	-	-	-	-
35	54.5-54.8			-	-	-	-	1	21	38	41	
36	56.0-56.5			-	-	-	-	-	-	-	-	-
37	56.5-56.8			-	-	-	-	1	20	38	42	
38	58.0-58.5	-	-	-	-	-	-	-	-	-		
39	58.5-58.8	-	-	-	-	0	23	39	38			
40	60.5-61.0	-	-	-	-	1	25	38	37			
41	62.5-63.0	-	-	-	-	1	74	8	18			
42	63.0-63.5	BANNER FORMATION TILL		-	-	-	-	-	-	-	-	
43	66.5-67.0			-	-	-	-	1	82	11	-7	
44	69.0-69.5			-	-	-	-	-	-	-	-	-
45	71.9-72.2			-	-	-	-	4	23	44	33	
46	72.5-73.0			-	-	-	-	-	-	-	-	-
47	73.9-74.2			-	-	-	-	4	23	45	32	
48	74.5-75.0			-	-	-	-	-	-	-	-	-
49	77.0-77.3	-	-	-	-	4	23	46	31			
50	78.0-78.5	-	-	-	-	-	-	-	-	-		
51	80.7-81.0	BEDROCK		-	-	-	-	3	23	45	32	

CH-1 No.	X-Ray Data						Chemical Data					
	DI	M %	I %	C-K %	Cal cts/ sec	Dol cts/ sec	Zn mg/l	Cd mg/l	Cu mg/l	Pb mg/l	pH	CEC meg/ 100g
1	-	-	-	-	-	-	18.	-	18.	-	-	-
2	-	-	-	-	-	-	25.	-	26.	38.	7.6	4.5
3	-	-	-	-	-	-	-	-	-	-	-	-
4	-	-	-	-	-	-	17.	.04	14.	18.	7.5	5.6
5	-	-	-	-	-	-	-	-	-	-	-	-
6	-	-	-	-	-	-	17.	-	27.	27.	-	-
7	-	-	-	-	-	-	-	-	-	-	-	-
8	-	-	-	-	-	-	-	-	-	-	-	-
9	-	-	-	-	-	-	20.	-	24.	22.	-	-
10	-	-	-	-	-	-	-	-	-	-	-	-
11	-	-	-	-	-	-	34.	.62	20.	21.	6.9	2.5
12	-	-	-	-	-	-	-	-	-	-	-	-
13	-	-	-	-	-	-	-	-	-	-	-	-
14	-	-	-	-	-	-	40.	-	27.	22.	-	-
15	-	-	-	-	-	-	-	-	-	-	-	-
16	-	-	-	-	-	-	43.	1.5	23.	18.	-	-
17	-	-	-	-	-	-	32.	.20	21.	17.	-	-
18	-	-	-	-	-	-	-	-	-	-	-	-
19	-	-	-	-	-	-	27.	-	22.	18.	-	-
20	-	-	-	-	-	-	-	-	-	-	-	-
21	-	-	-	-	-	-	35.	.32	32.	46.	-	-
22	-	-	-	-	-	-	-	-	-	-	-	-
23	-	-	-	-	-	-	26.	-	-	-	-	-
24	-	-	-	-	-	-	17.	-	-	-	-	-
25	-	-	-	-	-	-	-	-	-	-	-	-
26	-	-	-	-	-	-	30.	-	-	-	-	-
27	-	-	-	-	-	-	-	-	-	-	-	-
28	-	-	-	-	-	-	35.	~.04	12	9.8	-	-
29	-	-	-	-	-	-	-	-	-	-	-	-
30	-	-	-	-	-	-	36	<.04	12.	12.	-	-
31	-	-	-	-	-	-	-	-	-	-	-	-
32	-	-	-	-	-	-	-	-	-	-	-	-
33	-	-	-	-	-	-	-	-	-	-	-	-
34	-	-	-	-	-	-	13.	<.04	7.6	8.8	-	-
35	-	-	-	-	-	-	-	-	-	-	-	-
36	-	-	-	-	-	-	12.	-	-	-	-	-
37	-	-	-	-	-	-	-	-	-	-	-	-
38	-	-	-	-	-	-	18.	-	14.	17.	-	-
39	-	-	-	-	-	-	-	-	-	-	-	-
40	-	-	-	-	-	-	24.	-	-	-	-	-
41	-	-	-	-	-	-	-	-	-	-	-	-
42	-	-	-	-	-	-	37.	.24	14.	10.	-	-
43	-	-	-	-	-	-	17.	.06	11.	3.	-	-
44	-	-	-	-	-	-	23.	~.04	5.1	3.2	-	-
45	-	-	-	-	-	-	-	-	-	-	-	-
46	-	-	-	-	-	-	48.	-	-	-	-	-
47	-	-	-	-	-	-	-	-	-	-	-	-
48	-	-	-	-	-	-	47.	.40	21.	22.	-	-
49	-	-	-	-	-	-	-	-	-	-	-	-
50	-	-	-	-	-	-	48.	<.04	12.	10.	-	-
51	-	-	-	-	-	-	-	-	-	-	-	-

No.	SITE B 3 L.S.= 449.93			Engineering Data				Grain Size					
	Depth of Sample (ft)	Unit Description	Graphic Log	W %	Gs	Void Ratio	Dry Den #/ft ³	Gvl %	Sd %	St %	Cl %		
1	2.4-2.9	PEORIA LOESS (6-69-25)		-	-	-	-	-	-	-	-		
2	2.9-3.4			-	-	-	-	1	6	69	25		
3	3.9-4.4			-	-	-	-	0	20	60	20		
4	5.0-5.5	ROXANNA SILT (20-52-28)		-	-	-	-	4	24	48	28		
5	6.0-6.5			-	-	-	-	1	16	48	36		
6	7.4-7.9	BERRY CLAY (47-26-27)		-	-	-	-	-	-	-	-		
7	7.9-8.4			-	-	-	-	1	45	25	30		
8	8.4-8.9			17.8	2.66	.49	112	-	-	-	-		
9	9.9-10.4			-	-	-	-	1	48	27	25		
10	10.4-10.9			-	-	-	-	-	-	-	-		
11	10.9-11.4	HAGARSTOWN (47-34-19)		-	-	-	-	1	49	27	24		
12	11.6-12.1			-	-	-	-	-	-	-	-		
13	12.1-12.6			-	-	-	-	15	47	34	19		
14	13.0-13.5	GLASFORD FORMATION TILL (42-38-20)		-	-	-	-	7	50	33	17		
15	14.0-14.5			-	-	-	-	5	40	46	14		
16	14.5-15.1			-	-	-	-	-	-	-	-		
17	15.1-15.6			-	-	-	-	14	47	37	16		
18	17.1-17.6			-	-	-	-	8	36	38	26		
19	18.1-18.6			-	-	-	-	7	37	38	25		
20	19.1-19.5			-	-	-	-	7	43	35	22		
21	20.1-20.6			-	-	-	-	5	27	47	26		
22	22.0-22.5	BANNER FORMATION TILL (31-41-28) (oxidized)		-	-	-	-	3	25	41	34		
23	22.9-23.0			-	-	-	-	25	38	38	24		
24	24.2-24.7			-	-	-	-	3	29	39	32		
25	25.0-25.5			-	-	-	-	4	32	40	28		
26	26.1-26.6			-	-	-	-	8	35	38	27		
27	26.9-27.4			-	-	-	-	5	37	40	23		
28	29.2-29.6			-	-	-	-	11	25	48	27		
29	31.0-31.5			-	-	-	-	18	34	42	24		
30	31.7-32.1			(unoxidized)		-	-	-	-	-	-	-	-
31	32.1-32.6					-	-	-	-	2	24	43	33
32	33.1-33.6	-	-			-	-	6	21	43	36		
33	34.1-34.3	-	-			-	-	-	-	-	-		
34	35.0-35.5	-	-			-	-	3	21	47	32		
35	36.0-36.5	(21-45-34)	-			-	-	-	-	-	-		
36	37.0-37.5	-	-			-	-	2	23	44	33		
37	37.7-38.1	-	-			-	-	2	19	47	34		
38	38.1-38.6	BEDROCK		-	-	-	-	-	-	-	-		
39	39.1-39.6			-	-	-	-	3	23	45	32		
40	40.0-40.5			-	-	-	-	5	18	46	36		
								2	21	45	34		

3 No.	X-Ray Data						Chemical Data					
	DI	M %	I %	c-k %	Cal cts/ sec	Dol cts/ sec	Zn mg/l	Cd mg/l	Cu mg/l	Pb mg/l	pH	CEC meg/ 100g
1	-	-	-	-	-	-	860	-	-	-	-	-
2	-	-	-	-	-	-	860	-	-	-	-	-
3	-	-	-	-	-	-	100	-	-	-	-	-
4	1.19	77.5	14.5	8	N.D.	N.D.	52	-	-	-	-	-
5	1.11	85.5	9	5.5	N.D.	15	34	-	-	-	-	-
6	-	-	-	-	-	-	170	-	-	-	-	-
7	1.15	93.5	4	2.5	N.D.	N.D.	22	-	-	-	7.0	8.4
8	-	-	-	-	-	-	-	-	-	-	-	-
9	1.30	93	4.5	2.5	11	14	26	-	-	-	6.9	7.7
10	-	-	-	-	-	-	40	-	-	-	-	-
11	1.22	93	4.5	2.5	10	11	28	-	-	-	-	-
12	-	-	-	-	-	-	29	-	-	-	-	-
13	1.88	70	22	8	N.D.	26	-	-	-	-	-	-
14	1.45	24	52	24	N.D.	38	38.	-	-	-	-	-
15	1.58	24	53.5	22.5	8	33	-	-	-	-	-	-
16	-	-	-	-	-	-	19	-	-	-	-	-
17	1.55	25.5	52	22.5	15	25	-	-	-	-	-	-
18	1.25	37	41	22	23	21	34	-	-	-	-	-
19	1.45	40	41	19	16	21	-	-	-	-	-	-
20	1.57	38	43.5	18.5	18	25	-	-	-	-	-	-
21	1.35	18	55	27	28	10	60	-	-	-	-	-
22	1.75	18.5	59	22.5	30	14	-	-	-	-	-	-
23	.67	10	45	45	14	13	56	-	-	-	-	-
24	3.2	25	62	13	28	15	52	-	-	-	-	-
25	4.1	22	67	11	30	20	-	-	-	-	-	-
26	2.9	22.5	63	14.5	38	13	-	-	-	-	-	-
27	2.5	18	65.5	17.5	37	30	44	-	-	-	-	-
28	1.8	17	60.5	22.5	21	16	44	-	-	-	-	-
29	2.1	7	71	22	40	5	-	-	-	-	-	-
30	-	-	-	-	-	-	56	-	-	-	-	-
31	1.1	16.5	52	31.5	40	12	-	-	-	-	-	-
32	.92	17.5	48	34.5	19	13	-	-	-	-	-	-
33	-	-	-	-	-	-	160	-	-	-	-	-
34	.94	19	47	33.5	24	N.D.	-	-	-	-	-	-
35	1.0	14	52	34	15	N.D.	-	-	-	-	-	-
36	.85	12	49.5	38.5	19	10	-	-	-	-	-	-
37	-	-	-	-	-	-	52	-	-	-	-	-
38	.96	12.5	51.5	36	35	10	-	-	-	-	-	-
39	.84	16	43	37	27	18	-	-	-	-	-	-
40	.85	11.5	50	39	21	16	-	-	-	-	-	-

No.	SITE B 5 L.S = 447.55			Engineering Data				Grain Size				
	Depth of Sample (ft)	Unit Description	Graphic Log	W %	Gs	Void Ratio	Dry Den #/ft ³	Gvl %	Sd %	St %	Cl %	
1	0-0.5	PEORIA LOESS (3-77-20)		-	-	-	-	-	-	-	-	
2	0.5-1.0			-	-	-	-	-	-	-	-	-
3	1.0-1.5			-	-	-	-	-	-	-	-	-
4	2.0-2.5			-	-	-	-	-	-	-	-	-
5	2.5-3.0			-	-	-	-	-	0	3	79	18
6	3.0-3.5			-	-	-	-	-	0	5	77	18
7	3.5-4.0			-	-	-	-	-	0	2	76	22
8	4.0-4.5	ROXANNA SILT (14-61-25)		-	-	-	-	1	12	70	18	
9	4.5-5.0			-	-	-	-	-	1	12	66	22
10	5.0-5.5			27.8	-	-	-	-	1	10	65	25
11	5.5-5.6			-	-	-	-	-	1	12	59	29
12	6.0-6.5			-	-	-	-	-	2	12	64	24
13	6.5-7.0			-	-	-	-	-	1	15	60	25
14	7.0-7.5			-	-	-	-	-	2	23	48	29
15	7.5-8.0	BERRY CLAY (35-38-27)		-	-	-	-	1	27	43	30	
16	8.0-8.5			-	-	-	-	-	13	53	26	21
17	8.5-9.0			-	-	-	-	-	-	-	-	-
18	9.0-9.4			-	-	-	-	-	2	13	61	26
19	9.5-10.0			-	-	-	-	-	7	46	28	26
20	10.0-10.5			-	-	-	-	-	3	40	32	28
21	10.6-11.1			-	-	-	-	-	11	32	38	30
22	11.1-11.6	HAGARSTOWN		-	-	-	-	13	55	23	22	
23	11.6-11.8			24.2	-	-	-	-	-	-	-	-
24	11.8-12.3	GLASFORD FORMATION TILL (37-39-24)		-	-	-	-	-	-	-	-	
25	12.3-12.8			-	-	-	-	-	-	-	-	-
26	13.5-14.0			-	-	-	-	-	7	40	38	22
27	14.1-14.6			-	-	-	-	-	11	35	39	26
28	14.6-15.1			-	-	-	-	-	-	-	-	-
29	16.1-16.6			-	-	-	-	-	2	17	36	47
30	16.6-17.1			-	-	-	-	-	-	-	-	-
31	17.1-17.6	-	-	-	-	-	3	24	36	40		
32	17.6-18.1	GLASFORD FORMATION TILL (31-40-29) (oxidized)		-	-	-	-	-	-	-	-	
33	18.1-18.6			-	-	-	-	-	-	-	-	-
34	18.6-19.1			-	-	-	-	-	29	48	28	24
35	19.1-19.6			-	-	-	-	-	5	31	39	30
36	20.3-20.8			-	-	-	-	-	5	29	41	30
37	20.8-21.3			-	-	-	-	-	4	32	42	26
38	21.3-21.8			-	-	-	-	-	-	-	-	-
39	21.8-22.3			-	-	-	-	-	5	32	42	26
40	22.4-22.9			12.4	-	-	-	-	-	-	-	-
41	22.9-23.4			-	-	-	-	-	-	-	-	-
42	23.4-23.9	-	-	-	-	-	5	38	33	29		
43	23.9-24.4	-	-	-	-	-	4	25	50	25		
44	24.5-25.0	(unoxidized) (35-33-32)		-	-	-	-	-	-	-	-	
45	25.0-25.5			-	-	-	-	-	4	24	52	24
46	25.5-26.0			-	-	-	-	-	-	-	-	-
47	26.0-26.3			-	-	-	-	-	12	41	37	22
48	26.3-26.8			-	-	-	-	-	-	-	-	-
49	26.8-27.3			-	-	-	-	-	7	38	35	27
50	27.3-27.8			-	-	-	-	-	-	-	-	-
51	27.8-28.0	-	-	-	-	-	-	-	-	-		

5 No.	X-Ray Data						Chemical Data					
	DI	M %	I %	C-K %	Cal cts/ sec	Dol cts/ sec	Zn mg/l	Cd mg/l	Cu mg/l	Pb mg/l	pH	CEC meg/ 100g
1	—	—	—	—	—	—	4200	5.8	2,200	2,000	4.80	—
2	—	—	—	—	—	—	2200	12	270	210	5.20	—
3	—	—	—	—	—	—	1200	19	260	140	4.45	—
4	—	—	—	—	—	—	520	2.2	100	480	4.40	—
5	—	—	—	—	—	—	320	1.3	82	390	4.50	—
6	—	—	—	—	—	—	350	.94	58	240	4.15	—
7	—	—	—	—	—	—	340	.96	48	84	4.00	—
8	—	—	—	—	—	—	440	.04	39	16	3.90	—
9	—	—	—	—	—	—	720	1.7	7.7	6.9	3.65	—
10	—	—	—	—	—	—	—	—	—	—	—	—
11	1.3	—	—	—	—	—	680	1.6	9.6	9.3	3.82	—
12	1.5	—	—	—	—	—	1700	3.0	18	19	4.20	—
13	1.4	61.5	36.5	12	N.D.	N.D.	1800	3.6	9.6	11.	4.50	—
14	1.3	67	22	11	N.D.	N.D.	2600	6.4	13	23	5.45	—
15	1.35	80	13.5	6.5	N.D.	15	—	—	—	—	—	—
16	1.6	75	17.5	7.5	N.D.	N.D.	1900	7.2	15	27	5.25	—
17	—	—	—	—	—	—	1800	4.0	8.9	12.	5.48	—
18	1.8	63	24	13	N.D.	N.D.	2200	2.6	13.	12.	5.40	—
19	1.16	83	11	6	N.D.	N.D.	—	—	—	—	—	—
20	1.27	86.5	9	4.5	N.D.	N.D.	—	—	—	—	—	—
21	1.5	81	13	6	N.D.	N.D.	1600	5.6	18.	33.	5.80	—
22	1.3	79	14	7	N.D.	N.D.	2200	3.2	13.	14.	5.75	—
23	—	—	—	—	—	—	—	—	—	—	—	—
24	—	—	—	—	—	—	840	2.1	8.1	10	7.85	—
25	—	—	—	—	—	—	79	.10	18	16	7.65	—
26	2.1	39	46.5	14.5	25	31	—	—	—	—	—	—
27	2.7	41	37	12	19	29	400	.78	9.6	10	7.47	—
28	—	—	—	—	—	—	76	<.04	2.4	15	7.30	—
29	1.7	37	45	18	N.D.	N.D.	88	<.04	2.3	15	7.30	—
30	—	—	—	—	—	—	—	—	—	—	7.30	—
31	1.97	21	59	20	N.D.	N.D.	—	—	—	—	7.80	—
32	—	—	—	—	—	—	—	—	—	—	7.90	—
33	—	—	—	—	—	—	—	—	—	—	7.95	—
34	—	—	—	—	22	12	—	—	—	—	7.92	—
35	2.1	18	62	20	31	17	51	≈.02	15	9.5	7.97	—
36	2.8	23	62	15	50	16	—	—	—	—	7.97	—
37	3.5	26	62	12	36	18	—	—	—	—	8.10	—
38	—	—	—	—	—	—	—	—	—	—	7.95	—
39	3.2	28	59.5	12.5	50	16	47	.22	41	31	7.97	—
40	—	—	—	—	—	—	—	—	—	—	—	—
41	—	—	—	—	—	—	—	—	—	—	7.90	—
42	3.6	28	60.5	11.5	40	19	—	—	—	—	7.90	—
43	2.76	34	53	13	36	11	—	—	—	—	7.86	—
44	—	—	—	—	—	—	—	—	—	—	7.85	—
45	2.85	33.5	54	12.5	32	12	—	—	—	—	—	—
46	—	—	—	—	—	—	—	—	—	—	8.00	—
47	3.2	23.5	63.5	13	17	22	—	—	—	—	8.03	—
48	—	—	—	—	—	—	—	—	—	—	8.01	—
49	4.8	13.5	76	10.5	28	12	—	—	—	—	8.08	—
50	—	—	—	—	—	—	—	—	—	—	8.08	—
51	—	—	—	—	—	—	66	.05	17.	11.	7.98	—

No.	SITE B 5 L.S. = 447.55			Engineering Data				Grain Size				
	Depth of Sample (ft)	Unit Description	Graphic Log	W %	Gs	Void Ratio	Dry Den #/ft ³	Gvl %	Sd %	St %	Cl %	
52	28.0-28.5	BANNER FORMATION TILL (35-33-32)		—	—	—	—	3	24	43	33	
53	28.6-29.1			14.0	—	—	—	—	—	—	—	—
54	29.1-29.6			—	—	—	—	—	17	45	29	26
55	29.6-30.1			—	—	—	—	—	—	—	—	—
56	30.1-30.6			—	—	—	—	—	20	48	25	27
57	30.6-31.1			—	—	—	—	—	—	—	—	—
58	31.1-31.6			—	—	—	—	—	16	47	27	26
59	31.6-32.1			12.5	—	—	—	—	—	—	—	—
60	32.1-32.4			—	—	—	—	—	—	—	—	—
61	33.0-33.5			—	—	—	—	—	5	23	36	41
62	33.5-34.0			—	—	—	—	—	—	—	—	—
63	34.0-34.5			—	—	—	—	—	4	21	45	34
64	34.5-35.0			—	—	—	—	—	—	—	—	—
65	35.0-35.5			—	—	—	—	—	11	31	38	31
66	35.5-36.0	—	—	—	—	—	—	—	—	—		
67	36.0-36.4	—	—	—	—	—	5	20	45	35		
68	36.5-37.0	—	—	—	—	—	—	—	—	—		
69	37.0-37.5	—	—	—	—	—	4	20	47	33		
70	37.5-38.0	—	—	—	—	—	—	—	—	—		
71	38.0-38.5	ENION FORMATION (7-48-45)		21.1	—	—	—	6	24	38	38	
72	38.6-39.1			—	—	—	—	—	—	—	—	—
73	39.1-39.6			—	—	—	—	—	2	5	47	47
74	39.6-40.1			—	—	—	—	—	—	—	—	—
75	40.1-40.6			—	—	—	—	—	1	10	46	44
76	40.6-41.1			—	—	—	—	—	—	—	—	—
77	41.1-41.6			—	—	—	—	—	6	8	49	43
78	41.7-42.2			—	—	—	—	—	—	—	—	—
79	42.2-42.7			—	—	—	—	—	6	10	52	38
80	42.7-43.2			—	—	—	—	—	—	—	—	—
81	43.2-43.7			—	—	—	—	—	25	18	51	31
82	43.7-44.2			23.5	—	—	—	—	—	—	—	—
83	44.2-44.7			—	—	—	—	—	—	—	—	—
84	44.7-45.2			—	—	—	—	—	0	4	56	40
85	45.2-45.7	—	—	—	—	—	1	6	46	48		
86	46.2-46.4	—	—	—	—	—	0	6	45	49		
87	46.4-46.9	—	—	—	—	—	0	7	44	49		
88	46.9-47.4	—	—	—	—	—	—	—	—	—		
89	47.4-47.9	—	—	—	—	—	0	4	48	48		
90	47.9-48.4	—	—	—	—	—	0	4	39	57		
91	48.4-48.9	BEDROCK (2-49-49)		20.3	—	—	—	0	—	—	—	
92	48.9-49.4			—	—	—	—	—	0	2	53	45
93	49.4-49.8			—	—	—	—	—	—	—	—	—
94	49.8-50.3			—	—	—	—	—	0	1	48	51
95	50.3-50.8			—	—	—	—	—	—	—	—	—
96	50.8-51.3			—	—	—	—	—	0	3	48	49
97	51.3-51.8			—	—	—	—	—	—	—	—	—
98	51.8-52.3			—	—	—	—	—	0	2	49	49

5 No.	X-Ray Data						Chemical Data					
	DI	M %	I %	C-K %	Cal cts/ sec	Dol cts/ sec	Zn mg/l	Cd mg/l	Cu mg/l	Pb mg/l	pH	CEC meg/ 100g
52	2.1	18.5	62	19.5	28	12	—	—	—	—	—	—
53	—	—	—	—	—	—	—	—	—	—	—	—
54	1.05	17	51	32	15	N.D.	—	—	—	—	8.08	—
55	—	—	—	—	—	—	—	—	—	—	8.08	—
56	1.03	10.5	54.5	35	15	21	61	.08	270	33	8.06	—
57	—	—	—	—	—	—	—	—	—	—	7.92	—
58	0.9	13	51	36	N.D.	N.D.	—	—	—	—	8.10	—
59	—	—	—	—	—	—	—	—	—	—	—	—
60	—	—	—	—	—	—	—	—	—	—	7.65	—
61	1.07	26	45	28	34	15	—	—	—	—	7.70	—
62	—	—	—	—	—	—	—	—	—	—	7.65	—
63	0.9	20.5	45	34.5	24	N.D.	—	—	—	—	7.50	—
64	—	—	—	—	—	—	60	.12	15	13	7.00	—
65	0.8	15	46	39	20	N.D.	—	—	—	—	7.60	—
66	—	—	—	—	—	—	—	—	—	—	7.69	—
67	0.6	20	39	41	24	12	—	—	—	—	7.75	—
68	—	—	—	—	—	—	—	—	—	—	7.78	—
69	0.7	18.5	41	40.5	N.D.	N.D.	—	—	—	—	7.75	—
70	—	—	—	—	—	—	—	—	—	—	7.80	—
71	0.9	14.5	50	36	N.D.	N.D.	—	—	—	—	—	—
72	—	—	—	—	—	—	86	.40	24	21	7.70	—
73	0.7	23	40	37	N.D.	N.D.	—	—	—	—	7.70	—
74	—	—	—	—	—	—	—	—	—	—	7.25	—
75	0.5	26.5	30	44	N.D.	N.D.	—	—	—	—	7.60	—
76	—	—	—	—	—	—	—	—	—	—	7.70	—
77	0.5	26.5	29.5	44	N.D.	N.D.	—	—	—	—	7.35	—
78	—	—	—	—	—	—	—	—	—	—	7.55	—
79	0.5	30.5	30.5	39	N.D.	N.D.	—	—	—	—	7.60	—
80	—	—	—	—	—	—	61	.68	38	71	7.52	—
81	—	—	—	—	—	—	—	—	—	—	7.55	—
82	—	—	—	—	—	—	—	—	—	—	—	—
83	—	—	—	—	—	—	—	—	—	—	7.80	—
84	0.6	46	25	29	N.D.	N.D.	—	—	—	—	7.20	—
85	0.6	41	26.5	32.5	N.D.	N.D.	—	—	—	—	7.70	—
86	0.5	36	25.5	38	N.D.	N.D.	—	—	—	—	7.90	—
87	0.5	46	24	30	N.D.	N.D.	—	—	—	—	7.63	—
88	—	—	—	—	—	—	36.	<.02	15	14	7.60	—
89	0.5	46	23.5	31.5	N.D.	N.D.	—	—	—	—	6.72	—
90	0.5	38.5	25.5	36	N.D.	N.D.	—	—	—	—	7.56	—
91	—	—	—	—	—	—	—	—	—	—	—	—
92	0.7	16	42	42	N.D.	N.D.	—	—	—	—	7.72	—
93	—	—	—	—	—	—	—	—	—	—	7.83	—
94	1.0	16	49	35	N.D.	30	—	—	—	—	—	—
95	—	—	—	—	—	—	120.	.12	20	13	8.00	—
96	1.2	11	58	31	N.D.	N.D.	—	—	—	—	8.07	—
97	—	—	—	—	—	—	—	—	—	—	8.10	—
98	1.7	9	65	26	N.D.	N.D.	—	—	—	—	8.00	—

No.	SITE B 8 L.S. = 457.88			Engineering Data				Grain size				
	Depth of Sample (ft)	Unit Description	Graphic Log	W %	Gs	Void Ratio	Dry Den #/ft ³	Gvl %	Sd %	St %	Cl %	
1	0.5-1.0	PEORIA LOESS (2-61-37)		29.7	-	-	-	-	-	-	-	
2	1.0-1.5			-	-	-	-	1	20	53	27	
3	1.5-2.0			-	-	-	-	-	-	-	-	
4	2.0-2.5			-	-	-	-	1	2	68	30	
5	2.5-3.0			-	-	-	-	-	-	-	-	
6	3.0-3.5			-	-	-	-	1	2	51	47	
7	3.5-3.7			-	-	-	-	-	-	-	-	
8	4.0-4.5			-	-	-	-	-	-	-	-	
9	5.0-5.5			-	-	-	-	25.3	2	1	65	34
10	6.0-6.5			-	-	-	-	-	0	0	72	28
11	6.5-7.0	ROXANNA SILT AND BERRY CLAY (13-52-35)		-	-	-	-	-	-	-		
12	7.0-7.5			-	-	-	-	1	7	61	32	
13	8.6-9.1			-	-	-	-	-	-	-	-	
14	9.1-9.6			-	-	-	-	-	-	-	-	
15	10.2-10.7			-	-	-	-	26.1	0	10	55	35
16	10.7-11.2			-	-	-	-	-	-	-	-	
17	12.0-12.5			-	-	-	-	-	1	12	51	37
18	12.5-13.0			-	-	-	-	-	-	-	-	-
19	13.0-13.4			-	-	-	-	22.5	-	-	-	-
20	14.2-14.7			-	-	-	-	-	-	-	-	-
21	14.7-15.2	-	-	-	-	-	2	26	36	38		
22	17.0-17.5	-	-	-	-	-	1	8	57	35		
23	18.2-18.7	HAGARSTOWN (37-39-24)		-	-	-	-	8	38	34	28	
24	19.0-19.5			-	-	-	-	5	37	31	24	
25	19.5-20.0			-	-	-	-	-	-	-	-	
26	20.0-20.5			-	-	-	-	15.7	5	37	42	21
27	21.0-21.5			-	-	-	-	-	3	33	40	27
28	22.0-22.5	BANNER FORMATION TILL (30-42-28)		-	-	-	-	-	-	-	-	
29	23.5-24.0			-	-	-	-	11.1	-	-	-	-
30	24.0-24.5			-	-	-	-	-	5	30	40	30
31	26.2-26.7			-	-	-	-	-	-	-	-	-
32	26.7-27.2			-	-	-	-	-	-	-	-	-
33	27.2-27.7			-	-	-	-	-	3	34	44	22
34	27.7-28.2			-	-	-	-	-	-	-	-	-
35	28.6-29.1			-	-	-	-	-	-	-	-	-
36	29.1-29.6			-	-	-	-	-	-	-	-	-
37	29.6-30.1			-	-	-	-	12.8	-	-	-	-
38	30.5-31.0	-	-	-	-	-	-	-	-	-		
39	31.0-31.5	-	-	-	-	-	8	21	45	34		
40	31.5-32.0	-	-	-	-	-	-	-	-	-		
41	32.0-32.5	-	-	-	-	-	-	-	-	-		
42	32.5-33.0	-	-	-	-	-	-	-	-	-		
43	33.0-33.5	-	-	-	-	-	-	-	-	-		
44	35.0-35.5	-	-	-	-	17.4	-	-	-	-		
45	36.0-36.5	-	-	-	-	-	3	23	46	31		
46	38.1-38.6	-	-	-	-	21.1	-	-	-	-		
47	39.1-39.6	-	-	-	-	-	0	39	37	24		
48	40.0-40.5	-	-	-	-	-	1	58	27	15		
49	41.0-41.5	ENION FORMATION		-	-	-	-	0	10	46	44	
50	42.3-42.8			-	-	-	-	-	-	-	-	-
51	43.0-43.5			-	-	-	-	15.8	0	3	53	44

8 No.	X-Ray Data						Chemical Data					
	DI	M %	I %	C-K %	Cal cts/ sec	DoI cts/ sec	Zn mg/l	Cd mg/l	Cu mg/l	Pb mg/l	pH	CEC meg/ 100g
1	-	-	-	-	-	-	-	-	-	-	-	-
2	-	-	-	-	-	-	480	-	-	-	4.25	-
3	-	-	-	-	-	-	230	-	-	-	4.10	-
4	-	-	-	-	-	-	-	-	-	-	-	-
5	-	-	-	-	-	-	230	-	-	-	3.97	-
6	-	-	-	-	-	-	-	-	-	-	-	-
7	-	-	-	-	-	-	69	-	-	-	5.13	-
8	-	-	-	-	-	-	-	-	-	-	-	-
9	-	-	-	-	-	-	-	-	-	-	6.00	-
10	-	-	-	-	-	-	-	-	-	-	-	-
11	-	-	-	-	-	-	44	-	-	-	6.20	-
12	-	-	-	-	-	-	15	-	-	-	6.31	-
13	-	-	-	-	-	-	91	-	-	-	-	-
14	-	-	-	-	-	-	-	-	-	-	-	-
15	-	-	-	-	-	-	21	-	-	-	-	-
16	-	-	-	-	-	-	150	-	-	-	-	-
17	-	-	-	-	-	-	-	-	-	-	-	-
18	-	-	-	-	-	-	32	-	-	-	-	-
19	-	-	-	-	-	-	-	-	-	-	-	-
20	-	-	-	-	-	-	43	-	-	-	6.60	-
21	-	-	-	-	-	-	-	-	-	-	-	-
22	-	-	-	-	-	-	-	-	-	-	-	-
23	-	-	-	-	-	-	40	-	-	-	8.02	-
24	-	-	-	-	-	-	-	-	-	-	-	-
25	-	-	-	-	-	-	-	-	-	-	-	-
26	-	-	-	-	-	-	-	-	-	-	-	-
27	-	-	-	-	-	-	-	-	-	-	-	-
28	-	-	-	-	-	-	59	-	-	-	8.03	-
29	-	-	-	-	-	-	-	-	-	-	-	-
30	-	-	-	-	-	-	-	-	-	-	-	-
31	-	-	-	-	-	-	-	-	-	-	8.01	-
32	-	-	-	-	-	-	-	-	-	-	8.08	-
33	-	-	-	-	-	-	-	-	-	-	8.10	-
34	-	-	-	-	-	-	-	-	-	-	8.01	-
35	-	-	-	-	-	-	-	-	-	-	7.95	-
36	-	-	-	-	-	-	-	-	-	-	7.93	-
37	-	-	-	-	-	-	-	-	-	-	-	-
38	-	-	-	-	-	-	-	-	-	-	7.95	-
39	-	-	-	-	-	-	-	-	-	-	7.94	-
40	-	-	-	-	-	-	-	-	-	-	8.00	-
41	-	-	-	-	-	-	81	-	-	-	7.94	-
42	-	-	-	-	-	-	-	-	-	-	7.90	-
43	-	-	-	-	-	-	-	-	-	-	7.99	-
44	-	-	-	-	-	-	-	-	-	-	-	-
45	-	-	-	-	-	-	-	-	-	-	-	-
46	-	-	-	-	-	-	-	-	-	-	-	-
47	-	-	-	-	-	-	19	-	-	-	8.35	-
48	-	-	-	-	-	-	-	-	-	-	-	-
49	-	-	-	-	-	-	-	-	-	-	-	-
50	-	-	-	-	-	-	-	-	-	-	-	-
51	-	-	-	-	-	-	-	-	-	-	-	-

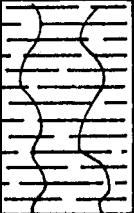
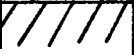
		SITE B 8 L.S. = 457.88		Engineering Data				Grain Size				
No.	Depth of Sample (ft)	Unit Description	Graphic Log	W %	Gs	void Ratio	Dry Den #/ft ³	Gvl %	Sd %	St %	Cl %	
52	44.4-44.9	ENION FORMATION (5-53-42)		-	-	-	-	-	-	-	-	
53	45.0-45.5			-	-	-	-	0	4	56	40	
54	46.0-46.5			24.0	-	-	-	-	-	-	-	-
55	49.0-49.5			-	-	-	-	1	5	58	37	
56	52.0-52.5			-	-	-	-	0	4	52	44	
57	53.0-53.5			-	-	-	-	-	-	-	-	-
58	54.0-54.5	BEDROCK		20.7	-	-	-	-	-	-	-	

8 No.	X-Ray Data						Chemical Data					
	DI	M %	I %	C-K %	Cal cts/ sec	Dol cts/ sec	Zn mg/l	Cd mg/l	Cu mg/l	Pb mg/l	pH	CEC meg/ 100g
52	-	-	-	-	-	-	14	-	-	-	7.70	-
53	-	-	-	-	-	-	-	-	-	-	-	-
54	-	-	-	-	-	-	-	-	-	-	-	-
55	-	-	-	-	-	-	-	-	-	-	-	-
56	-	-	-	-	-	-	-	-	-	-	-	-
57	-	-	-	-	-	-	76	-	-	-	7.50	-
58	-	-	-	-	-	-	-	-	-	-	-	-

NO.	SITE B CH-2 L.S. = 445			Engineering Data				Grain Size				
	Depth of Sample (ft)	Unit Description	Graphic Log	W %	Gs	Void Ratio	Dry Den #/ft ³	Gvl %	Sd %	St %	Cl %	
1	1.0-1.5	PEORIA LOESS AND ROXANA SILT (5-62-33)		-	-	-	-	0	3	73	24	
2	1.5-2.0			-	-	-	-	-	-	-	-	-
3	2.0-2.5			-	-	-	-	-	0	5	57	38
4	2.9-3.3			-	-	-	-	-	-	-	-	-
5	3.7-4.0			-	-	-	-	-	1	8	55	37
6	4.3-4.8			-	-	-	-	-	-	-	-	-
7	5.1-5.3			-	-	-	-	-	-	-	-	-
8	6.2-6.5			-	-	-	-	-	3	45	34	21
9	7.3-7.5			BERRY CLAY (44-25-31)		-	-	-	-	3	39	28
10	7.7-8.2	-	-			-	-	-	-	-	-	-
11	8.2-8.7	-	-			-	-	-	-	-	-	-
12	8.7-9.0	-	-			-	-	-	-	-	-	-
13	9.0-9.2	-	-			-	-	-	3	56	12	32
14	11.2-11.5	-	-			-	-	-	11	45	26	29
15	12.1-12.3	GLASFORD FORMATION TILL (33-44-23)		-	-	-	-	2	38	31	31	
16	13.0-13.5			-	-	-	-	-	-	-	-	-
17	13.8-14.1			-	-	-	-	-	8	26	46	28
18	14.8-15.3			-	-	-	-	-	5	35	39	26
19	16.0-16.3			-	-	-	-	-	5	35	39	26
20	16.5-17.0			-	-	-	-	-	-	-	-	-
21	18.5-19.0			-	-	-	-	-	6	33	42	25
22	20.5-21.0			-	-	-	-	-	-	-	-	-
23	22.5-23.0			-	-	-	-	-	3	35	41	24
24	24.3-24.8	LIERLE CLAY (22-39-39)		-	-	-	-	-	-	-	-	
25	25 -25.3			-	-	-	-	-	3	32	43	25
26	2 -27.3			-	-	-	-	-	1	20	38	42
27	28.0-28.5			-	-	-	-	-	-	-	-	-
28	29.7-30.0			-	-	-	-	-	1	20	38	42
29	30.7-31.0			-	-	-	-	-	1	25	40	35
30	31.5-31.8	BANNER FORMATION TILL (23-47-30)		-	-	-	-	9	26	44	30	
31	32.0-32.5			-	-	-	-	-	-	-	-	-
32	33.5-33.8			-	-	-	-	-	4	31	43	26
33	34.8-35.8			-	-	-	-	-	5	31	42	27
34	36.0-36.5			-	-	-	-	-	5	-	-	-
35	38.7-39.0			-	-	-	-	-	5	25	43	52
36	40.0-40.5			-	-	-	-	-	-	-	-	-
37	40.7-41.0			-	-	-	-	-	3	24	45	31
38	41.5-41.8			-	-	-	-	-	4	23	44	33
39	43.5-43.8			-	-	-	-	-	4	24	45	31
40	45.5-45.8			-	-	-	-	-	4	6	61	33
41	47.5-47.8	ENION FORMATION (5-62-33)		-	-	-	-	4	4	67	29	
42	50.5-50.7			-	-	-	-	-	3	16	53	31
43	51.4-51.7			-	-	-	-	-	3	17	54	29
44	53.4-53.7			-	-	-	-	-	8	15	54	31
45	55.4-55.7			-	-	-	-	-	0	4	57	39
46	57.5-57.8			-	-	-	-	-	0	7	31	62
47	59.5-59.8			-	-	-	-	-	0	4	60	36
48	61.5-61.8			-	-	-	-	-	0	4	62	34
49	63.5-63.6			-	-	-	-	-	0	4	65	31
50	65.3-65.6			-	-	-	-	-	0	4	70	26
51	67.5-67.8			BEDROCK		-	-	-	-	0	5	67

CH-2 No.	X-Ray Data						Chemical Data					
	DI	M %	I %	C-K %	Cal cts/ sec	DoI cts/ sec	Zn mg/l	Cd mg/l	Cu mg/l	Pb mg/l	pH	CEC meg/ 100g
1	-	-	-	-	-	-	-	-	-	-	5.7	3.9
2	-	-	-	-	-	-	19	<.02	9.7	12	4.6	4.1
3	-	-	-	-	-	-	-	-	-	-	5.2	7.1
4	-	-	-	-	-	-	-	-	-	-	6.1	5.0
5	-	-	-	-	-	-	19	<.02	9.9	12	-	-
6	-	-	-	-	-	-	-	-	-	-	6.2	3.9
7	-	-	-	-	-	-	-	-	-	-	6.3	5.1
8	-	-	-	-	-	-	11	<.02	5.0	6.8	-	-
9	-	-	-	-	-	-	-	-	-	-	-	-
10	-	-	-	-	-	-	-	-	-	-	6.4	7.1
11	-	-	-	-	-	-	-	-	-	-	6.5	3.9
12	-	-	-	-	-	-	14	<.02	6.6	8.2	-	-
13	-	-	-	-	-	-	-	-	-	-	-	-
14	-	-	-	-	-	-	14	<.02	7.5	7.7	-	-
15	-	-	-	-	-	-	-	-	-	-	-	-
16	-	-	-	-	-	-	38	.14	13	8.9	-	-
17	-	-	-	-	-	-	-	-	-	-	-	-
18	-	-	-	-	-	-	32	.08	11	7.5	-	-
19	-	-	-	-	-	-	-	-	-	-	-	-
20	-	-	-	-	-	-	38	<.02	12	8.3	-	-
21	-	-	-	-	-	-	24	.06	8.7	7.1	-	-
22	-	-	-	-	-	-	32	.06	11	-	-	-
23	-	-	-	-	-	-	-	-	-	-	-	-
24	-	-	-	-	-	-	46	.04	14	11	-	-
25	-	-	-	-	-	-	-	-	-	-	-	-
26	-	-	-	-	-	-	-	-	-	-	-	-
27	-	-	-	-	-	-	46	.14	19	12	-	-
28	-	-	-	-	-	-	-	-	-	-	-	-
29	-	-	-	-	-	-	-	-	-	-	-	-
30	-	-	-	-	-	-	-	-	-	-	-	-
31	-	-	-	-	-	-	44	.20	11	7.2	-	-
32	-	-	-	-	-	-	-	-	-	-	-	-
33	-	-	-	-	-	-	-	-	-	-	-	-
34	-	-	-	-	-	-	40	.06	15	8.9	-	-
35	-	-	-	-	-	-	-	-	-	-	-	-
36	-	-	-	-	-	-	46	.08	22	11	-	-
37	-	-	-	-	-	-	-	-	-	-	-	-
38	-	-	-	-	-	-	-	-	-	-	-	-
39	-	-	-	-	-	-	-	-	-	-	-	-
40	-	-	-	-	-	-	-	-	-	-	-	-
41	-	-	-	-	-	-	-	-	-	-	-	-
42	-	-	-	-	-	-	-	-	-	-	-	-
43	-	-	-	-	-	-	-	-	-	-	-	-
44	-	-	-	-	-	-	-	-	-	-	-	-
45	-	-	-	-	-	-	-	-	-	-	-	-
46	-	-	-	-	-	-	-	-	-	-	-	-
47	-	-	-	-	-	-	-	-	-	-	-	-
48	-	-	-	-	-	-	-	-	-	-	-	-
49	-	-	-	-	-	-	-	-	-	-	-	-
50	-	-	-	-	-	-	-	-	-	-	-	-
51	-	-	-	-	-	-	-	-	-	-	-	-

No.	SITE C 1 L.S. = 490.98			Engineering Data				Grain Size			
	Depth of Sample (ft)	Unit Description	Graphic Log	W %	Gs	Void Ratio	Dry Den #/ft ³	Gvl %	Sd %	St %	Cl %
1	0.5 - 1.0	FILL		-	-	-	-	-	-	-	-
2	2.8 - 3.5	HENRY FORMATION		-	-	-	-	-	-	-	-
3	4.0 - 4.5		-	-	-	-	-	-	-	-	-
4	6.0 - 6.5		-	-	-	-	-	-	-	-	-
5	7.5 - 8.0		-	-	-	-	-	-	-	-	-
6	9.5 - 10.0		-	-	-	-	-	-	-	-	-
7	11.7 - 12.3		-	-	-	-	-	-	-	-	-
8	13.5 - 14.0		-	-	-	-	-	-	-	-	-
9	15.7 - 16.3		-	-	-	-	-	-	-	-	-
10	18.5 - 19.0		-	-	-	-	-	-	-	-	-
11	20.5 - 21.0		-	-	-	-	-	-	-	-	-
12	22.5 - 23.0		-	-	-	-	-	-	-	-	-
13	24.0 - 24.5		-	-	-	-	-	-	-	-	-
14	26.5 - 27.0		-	-	-	-	-	-	-	-	-
15	28.6 - 29.3		-	-	-	-	-	-	-	-	-
16	30.5 - 31.0		-	-	-	-	-	-	-	-	-
17	32.0 - 34.0		-	-	-	-	-	-	-	-	-
18	34.0 - 36.0		-	-	-	-	-	-	-	-	-
19	36.0 - 38.0		-	-	-	-	-	-	-	-	-

No.	SITE C 4 L.S. = 464.82			Engineering Data				Grain Size				
	Depth of Sample (ft)	Unit Description	Graphic Log	W %	Gs	Void ratio	Dry Den #/ft ³	Gvl %	Sd %	St %	Cl %	
1	0.0 - 2.0	FILL		-	-	-	-	-	-	-	-	
2	2.0 - 3.0	GRAYSLAKE PEAT		-	-	-	-	-	-	-	-	
3	4.6 - 5.3		-	-	-	-	-	-	-	-	-	
4	6.5 - 7.0		-	-	-	-	-	-	-	-	-	
5	8.6 - 9.3		-	-	-	-	-	-	-	-	-	
6	10.6 - 11.3		-	-	-	-	-	-	-	-	-	
7	12.6 - 13.3		-	-	-	-	-	-	-	-	-	
8	14.5 - 15.0		-	-	-	-	-	-	-	-	-	
9	16.5 - 17.0		HENRY FM.		-	-	-	-	-	-	-	-

1 No.	X-Ray Data						Chemical Data					
	DI	M %	I %	C-K %	Cal cts/ sec	Do1 cts/ sec	Zn mg/l	Cd mg/l	Cu mg/l	Pb mg/l	pH	CEC meg/ 100g
1	-	-	-	-	-	-	83,000.	84.	3,200	37,000	-	-
2	-	-	-	-	-	-	1,500.	13.	17.	24.	-	-
3	-	-	-	-	-	-	5,000.	51.	11.	26.	-	-
4	-	-	-	-	-	-	2,000.	71.	18.	33.	-	-
5	-	-	-	-	-	-	7,100.	33.	18.	12.	-	-
6	-	-	-	-	-	-	3,700.	10.	11.	14.	-	-
7	-	-	-	-	-	-	25,000.	1.9	11.	3.9	-	-
8	-	-	-	-	-	-	16,000.	<.6	10.	6.3	-	-
9	-	-	-	-	-	-	360.	<.6	16.	52.	-	-
10	-	-	-	-	-	-	43.	<.6	11.	4.9	-	-
11	-	-	-	-	-	-	57.	<.6	16.	7.7	-	-
12	-	-	-	-	-	-	22.	<.6	7.3	<4	-	-
13	-	-	-	-	-	-	13.	<.6	5.2	11	-	-
14	-	-	-	-	-	-	17.	<.6	6.	<4	-	-
15	-	-	-	-	-	-	46.	.72	17.	17.	-	-
16	-	-	-	-	-	-	49.	1.5	20.	9	-	-
17	-	-	-	-	-	-	37.	1.1	14.	15.	-	-
18	-	-	-	-	-	-	45.	.36	9.4	2.8	-	-
19	-	-	-	-	-	-	37.	.9	9.3	17.	-	-

4 No.	X-Ray Data						Chemical Data					
	DI	M %	I %	C-K %	Cal cts/ seac	Do1 cts/ sec	Zn mg/l	Cd mg/l	Cu mg/l	Pb mg/l	pH	CEC meg/ 100g
1	-	-	-	-	-	-	29,000.	82.	3,500.	440.	6.75.	-
2	-	-	-	-	-	-	18,000.	86.	2,200.	6800.	6.50	-
3	-	-	-	-	-	-	7,700.	1400.	2,400.	16000.	6.25	-
4	-	-	-	-	-	-	1,600.	22.	50.	150.	5.45	-
5	-	-	-	-	-	-	49.	<.6	1.1	11.	7.52	-
6	-	-	-	-	-	-	34.	<.6	2.8	8.2	7.45	-
7	-	-	-	-	-	-	46.	<.6	11.	9.6	6.75	-
8	-	-	-	-	-	-	33.	<.6	11.	5.5	7.20	-
9	-	-	-	-	-	-	-	<.6	13.	<.4	7.57	-

No.	SITE C 6 L.S. = 456.29			Engineering Data				Grain Size			
	Depth of Sample (ft)	Unit Description	Graphic Log	W %	Gs	Void Ratio	Dry Den # / ft ³	Gvl %	Sd %	St %	Cl %
1	0.5-1.0	GRAYSLAKE PEAT		-	-	-	-	-	-	-	-
2	2.5-3.0			-	-	-	-	-	-	-	-
3	4.5-5.0			-	-	-	-	-	-	-	-
4	6.5-7.0			-	-	-	-	-	-	-	-
5	8.5-9.0			-	-	-	-	-	-	-	-
6	10.5-11.0			-	-	-	-	-	-	-	-
7	12.5-13.0			-	-	-	-	-	-	-	-
8	14.5-15.0			-	-	-	-	-	-	-	-
9	16.5-17.0			-	-	-	-	-	-	-	-
10	18.5-19.0		HENRY FORMATION		-	-	-	-	-	-	-
11	20.0-22.0			-	-	-	-	-	-	-	-
12	22.0-24.0			-	-	-	-	-	-	-	-

No.	SITE C 7 L.S. = 467.29			Engineering Data				Grain Size			
	Depth of Sample (ft)	Unit Description	Graphic Log	W %	Gs	Void Ratio	Dry Den # / ft ³	Gvl %	Sd %	St %	Cl %
1	0.5-1.0	FILL		-	-	-	-	-	-	-	-
2	4.5-5.0			-	-	-	-	-	-	-	-
3	6.5-7.0			-	-	-	-	-	-	-	-
4	12.5-13.0			-	-	-	-	-	-	-	-
5	14.5-15.0			-	-	-	-	-	-	-	-
6	18.5-19.0	GRAYSLAKE PEAT		-	-	-	-	-	-	-	-
7	20.5-21.0			-	-	-	-	-	-	-	-
8	22.5-23.0			-	-	-	-	-	-	-	-
9	24.5-25.0	HENRY FM.		-	-	-	-	-	-	-	-
10	26.5-27.0			-	-	-	-	-	-	-	-
11	28.5-29.0			-	-	-	-	-	-	-	-

6 No.	X-Ray Data						Chemical Data					
	DI	M %	I %	C-K %	Cal cts/ sec	Dol cts/ sec	Zn mg/l	Cd mg/l	Cu mg/l	Pb mg/l	pH	CEC meg/ 100g
1	-	-	-	-	-	-	2600.	27.	90.	250.	-	-
2	-	-	-	-	-	-	1100.	11.	9.5	56.	-	-
3	-	-	-	-	-	-	1200.	16.	28.	92.	-	-
4	-	-	-	-	-	-	6.	1.0	.56	<4.	-	-
5	-	-	-	-	-	-	110.	1.0	2.2	7.3	-	-
6	-	-	-	-	-	-	62.	<.6	7.6	12.	-	-
7	-	-	-	-	-	-	87.	<.6	19.	16.	-	-
8	-	-	-	-	-	-	14.	<.6	1.2	3.9	-	-
9	-	-	-	-	-	-	18.	<.6	3.5	11.	-	-
10	-	-	-	-	-	-	64.	<.6	18.	6.7	-	-
11	-	-	-	-	-	-	150.	<.6	16.	20.	-	-
12	-	-	-	-	-	-	30.	<.6	8.6	4.	-	-

7 No.	X-Ray Data						Chemical Data					
	DI	M %	I %	C-K %	Cal cts/ sec	Dol cts/ sec	Zn mg/l	Cd mg/l	Cu mg/l	Pb mg/l	pH	CEC meg/ 100g
1	-	-	-	-	-	-	52,000.	<.6	720.	3,300.	-	-
2	-	-	-	-	-	-	24,000.	120.	560.	1,200.	-	-
3	-	-	-	-	-	-	18,000.	71.	700.	2,600.	-	-
4	-	-	-	-	-	-	21,000.	120.	170.	960.	-	-
5	-	-	-	-	-	-	39,000.	300.	220.	1,200.	-	-
6	-	-	-	-	-	-	24.	2.2	.92	9.0	-	-
7	-	-	-	-	-	-	9.1	<.6	.20	<4.	-	-
8	-	-	-	-	-	-	24.	<.6	1.9	<4.	-	-
9	-	-	-	-	-	-	56.	<.6	8.8	16.	-	-
10	-	-	-	-	-	-	2,900.	<.6	19.	74.	-	-
11	-	-	-	-	-	-	-	<.6	18.	<4.	-	-

